

Site Development Controls:

1.0 Overview of Stormwater Controls for Site Development

2.0 Bioretention

3.0 Enhanced Swales

4.0 Grass Channel

5.0 Open Conveyance Channel

6.0 Alum Treatment System

7.0 Culverts

8.0 Inlets

9.0 Pipe Systems

10.0 Dry Detention / Extended Detention Dry Basins

11.0 Multi-Purpose Detention Areas

12.0 Underground Detention

13.0 Filter Strip

14.0 Organic Filter

15.0 Planter Boxes

16.0 Sand Filters

17.0 Underground Sand Filter

18.0 Gravity (Oil Grit) Separator

19.0 Downspout Drywell

20.0 Infiltration Trench

21.0 Soakage Trench

22.0 Stormwater Ponds

23.0 Green Roof

24.0 Modular Porous Pavement Systems

25.0 Porous Concrete

26.0 Proprietary Structural Controls

27.0 Rain Harvesting (Tanks/Barrels)

28.0 Stormwater Wetlands

29.0 Stormwater Control Design Examples

30.0 References

Table of Contents

1.0 Overview of Stormwater Controls for Site DevelopmentSD-1

1.1	Stormwater Controls - Categories and Applicability.....	SD-1
1.1.1	Introduction.....	SD-1
1.1.2	Control Categories	SD-1
1.1.3	Using Other or New Structural Stormwater Controls	SD-5
1.2	Suitability of Stormwater Controls.....	SD-5
1.2.1	Water Quality.....	SD-5
1.2.2	Streambank Protection.....	SD-6
1.2.3	Flood Control.....	SD-6
1.3	Stormwater Control Selection	SD-7
1.3.1	Control Screening Process.....	SD-7
1.3.2	Example Application.....	SD-14
1.4	On-Line Versus Off-Line Structural Controls	SD-16
1.4.1	Introduction.....	SD-16
1.4.2	Flow Regulators	SD-16
1.5	Regional Versus On-Site Stormwater Management.....	SD-19
1.5.1	Introduction.....	SD-19
1.5.2	Advantages and Disadvantages of Regional Stormwater Controls	SD-20
1.5.3	Important Considerations for the Use of Regional Stormwater Controls	SD-21
1.6	Using Structural Stormwater Controls in Series	SD-21
1.6.1	Stormwater Treatment Trains	SD-21
1.6.2	Use of Multiple Structural Controls in Series.....	SD-22
1.6.3	Calculation of Pollutant Removal for Structural Controls in Series	SD-25
1.6.4	Routing with WQ_v Removed.....	SD-26

2.0 Bioretention.....SD-28

2.1	General Description	SD-29
2.2	Stormwater Management Suitability.....	SD-31
2.3	Pollutant Removal Capabilities	SD-31
2.4	Application and Site Feasibility Criteria	SD-32
2.5	Planning and Design Criteria	SD-32
2.5.1	Location and Siting.....	SD-32
2.5.2	General Design	SD-33
2.5.3	Physical Specifications / Geometry.....	SD-34
2.5.4	Pretreatment / Inlets	SD-34
2.5.5	Outlet Structures	SD-34

2.5.6	Emergency Spillway	SD-35
2.5.7	Maintenance Access	SD-35
2.5.8	Safety Features	SD-35
2.5.9	Landscaping	SD-35
2.5.10	Additional Site-Specific Design Criteria and Issues	SD-35
2.6	Design Procedures	SD-36
2.7	Inspection and Maintenance Requirements	SD-38
2.8	Example Schematics	SD-39
3.0	Enhanced Swales	SD-44
3.1	General Description	SD-45
3.2	Stormwater Management Suitability	SD-46
3.3	Pollutant Removal Capabilities	SD-46
3.4	Application and Feasibility Criteria.....	SD-46
3.5	Planning and Design Criteria	SD-47
3.6	Design Procedures	SD-50
3.7	Inspection and Maintenance Requirements	SD-52
3.8	Example Schematics	SD-53
3.9	Design Forms.....	SD-55
4.0	Grass Channel	SD-56
4.1	General Description	SD-57
4.2	Pollutant Removal Capabilities	SD-57
4.3	Design Criteria and Specifications.....	SD-57
4.4	Inspection and Maintenance Requirements	SD-58
4.5	Example Schematics	SD-59
4.6	Design Example.....	SD-60
5.0	Open Conveyance Channel.....	SD-62
5.1	General Description	SD-63
5.2	Pollutant Removal Capabilities	SD-63
5.3	Design Criteria and Specifications.....	SD-63
5.4	Inspection and Maintenance Requirements	SD-64
6.0	Alum Treatment System	SD-65
6.1	General Description	SD-66
6.2	Pollutant Removal Capabilities	SD-66
6.3	Design Criteria and Specifications.....	SD-66
6.4	Inspection and Maintenance Requirements	SD-67
7.0	Culverts	SD-68

7.1	General Description	SD-69
7.2	Pollutant Removal Capabilities	SD-69
7.3	Design Criteria and Specifications	SD-69
7.4	Inspection and Maintenance Requirements	SD-70
7.5	Example Schematic	SD-70
8.0	Inlets	SD-71
8.1	General Description	SD-72
8.2	Pollutant Removal Capabilities	SD-72
8.3	Design Criteria and Specifications	SD-72
8.4	Inspection and Maintenance Requirements	SD-73
9.0	Pipe Systems	SD-74
9.1	General Description	SD-75
9.2	Pollutant Removal Capabilities	SD-75
9.3	Design Criteria and Specifications	SD-75
9.4	Inspection and Maintenance Requirements	SD-75
9.5	Example Schematic	SD-77
10.0	Dry Detention / Extended Detention Dry Basins.....	SD-78
10.1	General Description	SD-79
10.2	Design Criteria and Specifications	SD-79
10.3	Inspection and Maintenance Requirements	SD-80
10.4	Example Schematics	SD-81
11.0	Multi-Purpose Detention Areas.....	SD-83
11.1	General Description	SD-84
11.2	Design Criteria and Specifications	SD-84
11.3	Inspection and Maintenance Requirements	SD-85
12.0	Underground Detention.....	SD-86
12.1	General Description	SD-87
12.2	Design Criteria and Specifications	SD-87
12.3	Inspection and Maintenance Requirements	SD-88
12.4	Example Schematics	SD-89
13.0	Filter Strip.....	SD-91
13.1	General Description	SD-92
13.2	Pollutant Removal Capabilities	SD-92
13.3	Design Criteria and Specifications	SD-92
13.4	Inspection and Maintenance Requirements	SD-95

13.5	Example Schematic	SD-96
13.6	Design Example.....	SD-97
14.0	Organic Filter	SD-99
14.1	General Description	SD-100
14.2	Pollutant Removal Capabilities	SD-100
14.3	Design Criteria and Specifications.....	SD-100
14.4	Inspection and Maintenance Requirements	SD-100
14.5	Example Schematic	SD-101
15.0	Planter Boxes	SD-102
15.1	General Description	SD-103
15.2	Pollutant Removal Capabilities	SD-103
15.3	Design Criteria and Specifications.....	SD-103
15.4	Inspection and Maintenance Requirements	SD-103
15.5	Example Schematics	SD-104
16.0	Sand Filters	SD-106
16.1	General Description	SD-107
16.2	Stormwater Management Suitability.....	SD-108
16.3	Pollutant Removal Capabilities	SD-108
16.4	Application and Site Feasibility Criteria	SD-109
16.5	Planning and Design Criteria	SD-109
16.6	Design Procedures	SD-115
16.7	Inspection and Maintenance Requirements	SD-118
16.8	Example Schematics	SD-119
16.9	Design Forms.....	SD-121
17.0	Underground Sand Filter	SD-122
17.1	General Description	SD-123
17.2	Pollutant Removal Capabilities	SD-123
17.3	Design Criteria and Specifications.....	SD-123
17.4	Inspection and Maintenance Requirements	SD-123
17.5	Example Schematic	SD-124
18.0	Gravity (Oil Grit) Separator	SD-125
18.1	General Description	SD-126
18.2	Pollutant Removal Capabilities	SD-126
18.3	Design Criteria and Specifications.....	SD-126
18.4	Inspection and Maintenance Requirements	SD-127
18.5	Example Schematic	SD-128

19.0	Downspout Drywell.....	SD-129
19.1	General Description	SD-130
19.2	Pollutant Removal Capabilities	SD-130
19.3	Design Criteria and Specifications	SD-130
19.4	Inspection and Maintenance Requirements	SD-130
19.5	Example Schematic	SD-132
20.0	Infiltration Trench	SD-133
20.1	General Description	SD-134
20.2	Stormwater Management Suitability	SD-134
20.3	Pollutant Removal Capabilities	SD-135
20.4	Application and Site Feasibility Criteria	SD-135
20.5	Planning and Design Criteria	SD-136
20.6	Design Procedures	SD-139
20.7	Inspection and Maintenance Requirements	SD-140
20.8	Example Schematics	SD-142
20.9	Design Forms.....	SD-144
21.0	Soakage Trench	SD-145
21.1	General Description	SD-146
21.2	Pollutant Removal Capabilities	SD-146
21.3	Design Criteria and Specifications	SD-146
21.4	Inspection and Maintenance Requirements	SD-147
21.5	Example Schematics	SD-148
22.0	Stormwater Ponds	SD-149
22.1	General Description	SD-150
22.2	Stormwater Management Suitability	SD-151
22.3	Pollutant Removal Capabilities	SD-152
22.4	Application and Site Feasibility Criteria	SD-152
22.5	Planning and Design Criteria	SD-153
22.6	Design Procedures	SD-159
22.7	Inspection and Maintenance Requirements	SD-161
22.8	Example Schematics	SD-163
22.9	Design Forms.....	SD-167
23.0	Green Roof	SD-169
23.1	General Description	SD-170
23.2	Design Criteria and Specifications	SD-170
23.3	Inspection and Maintenance Requirements	SD-172

23.4	Example Schematic	SD-173
24.0	Modular Porous Paver Systems	SD-174
24.1	General Description	SD-175
24.2	Pollutant Removal Capabilities	SD-175
24.3	Design Criteria and Specifications	SD-176
24.4	Inspection and Maintenance Requirements	SD-177
24.5	Example Schematics	SD-178
25.0	Porous Concrete	SD-180
25.1	General Description	SD-181
25.2	Pollutant Removal Capabilities	SD-182
25.3	Design Criteria and Specifications	SD-182
25.4	Inspection and Maintenance Requirements	SD-184
25.5	Example Schematics	SD-185
25.6	Design Example	SD-187
26.0	Proprietary Structural Controls	SD-188
26.1	General Description	SD-189
26.2	Guidelines for Using Proprietary Systems	SD-189
27.0	Rain Harvesting (Tanks/Barrels)	SD-190
27.1	General Description	SD-191
27.2	Design Criteria and Specifications	SD-191
27.3	Example Schematics	SD-192
28.0	Stormwater Wetlands	SD-193
28.1	General Description	SD-194
28.2	Stormwater Management Suitability	SD-196
28.3	Pollutant Removal Capabilities	SD-196
28.4	Application and Site Feasibility Criteria	SD-197
28.5	Planning and Design Criteria	SD-197
28.6	Design Procedures	SD-204
28.7	Inspection and Maintenance Requirements	SD-206
28.8	Example Schematics	SD-208
28.9	Design Forms	SD-213
29.0	Stormwater Control Design Examples	SD-215
29.1	Introduction	SD-215
29.2	Stormwater Pond Design Example	SD-215
29.3	Bioretention Area Design Example	SD-232

29.4	Sand Filter Design Example	SD-240
29.5	Infiltration Trench Design Example.....	SD-253
29.6	Enhanced Swale Design Example.....	SD-264

30.0 ReferencesSD-273

List of Tables

Table 1.1	Structural Controls	SD-2
Table 1.2	Design Pollutant Removal Efficiencies for Stormwater Controls (Percentage)	SD-5
Table 1.3	Structural Control Screening Matrix.....	SD-10
Table 1.3	Structural Control Screening Matrix.....	SD-10
Table 1.4	Location and Permitting Checklist.....	SD-13
Table 1.5	Sample Structural Control Selection Matrix	SD-15
Table 2.1	Typical Maintenance Activities for Bioretention Areas.....	SD-38
Table 2.2	Design Procedure Form: Bioretention Areas	SD-43
Table 3.1	Typical Maintenance Activities for Enhanced Swales.....	SD-52
Table 4.1	Bioretention Grass Channel Sizing Guidance	SD-58
Table 4.2	Typical Maintenance Activities for Grass Channels.....	SD-58
Table 6.1	Typical Maintenance Activities for Alum Treatment.....	SD-67
Table 10.1	Typical Maintenance Activities for Dry Detention / Extended Detention Dry Basins	SD-80
Table 11.1	Typical Maintenance Activities for Multi-Purpose Detention Areas	SD-85
Table 12.1	Typical Maintenance Activities for Underground Detention Systems	SD-88
Table 13.1	Bioretention Filter Strip Sizing Guidance	SD-94
Table 13.2	Typical Maintenance Activities for Filter Strips	SD-95
Table 15.1	Typical Maintenance Activities for Planter Boxes	SD-104
Table 16.1	Typical Maintenance Activities for Sand Filters	SD-118
Table 17.1	Typical Maintenance Activities for Underground Sand Filters	SD-123
Table 18.1	Typical Maintenance Activities for Gravity Separators	SD-127
Table 19.1	Typical Maintenance Activities for Drywells.....	SD-131
Table 20.1	Typical Maintenance Activities for Infiltration Trenches.....	SD-140
Table 21.1	Typical Maintenance Activities for Soakage Trenches	SD-147
Table 22.1	Typical Maintenance Activities for Ponds	SD-161
Table 23.1	Typical Maintenance Activities for Green Roofs	SD-172
Table 24.1	Typical Maintenance Activities for Modular Porous Paver Systems.....	SD-177
Table 25.1	Typical Maintenance Activities for Porous Concrete Systems	SD-184
Table 28.1	Recommended Design Criteria for Stormwater Wetlands	SD-199

Table 28.2	Typical Maintenance Activities for Wetlands	SD-206
Table 29.1	Summary of General Storage Requirements for Rolling Meadows	SD-218
Table 29.2	Summary of Controls Provided	SD-229
Table 29.3	Summary of General Design Information for Wellington Recreation Center	SD-234
Table 29.4	Pretreatment Grass Channel Guidance for 1.0 Acre Drainage Area.....	SD-239
Table 29.5	Summary of General Design Information for Falcon Creek Community Center.....	SD-242
Table 29.6	Summary of General Design Info for Falcon Creek Community Center.....	SD-255
Table 29.7	Site Specific Data.....	SD-258
Table 29.8	Infiltration Feasibility.....	SD-258
Table 29.9	Summary of General Design Information for Wellington Recreation Center	SD-266

List of Figures

Figure 1.1	Example of On-Line versus Off-Line Structural Controls.....	SD-17
Figure 1.2	Pipe Interceptor Diversion Structure	SD-18
Figure 1.3	Surface Channel Diversion Structure.....	SD-18
Figure 1.4	Outlet Flow Regulator	SD-19
Figure 1.5	On-Site versus Regional Stormwater Management	SD-19
Figure 1.6	Generalized Stormwater Treatment Train.....	SD-21
Figure 1.7	Examples of Structural Controls Used in Series	SD-22
Figure 1.8	Example Treatment Train – Residential Subdivision	SD-23
Figure 1.9	Example Treatment Train – Small Commercial Site.....	SD-24
Figure 1.10	Example Treatment Train – Large Commercial Development	SD-24
Figure 1.11	Curve Number Adjustment Factor	SD-27
Figure 2.1	Bioretention Area Examples	SD-29
Figure 2.2	Bioretention Area Applications.....	SD-30
Figure 2.3	Schematic of a Typical Bioretention Area	SD-39
Figure 2.4	Schematic of a Typical On-Line Bioretention Area	SD-40
Figure 2.5	Schematic of a Typical Off-Line Bioretention Area	SD-41
Figure 2.6	Schematic of a Typical Inlet Deflector.....	SD-42
Figure 3.1	Enhanced Swale Examples	SD-45
Figure 3.2	Schematic of Dry Swale	SD-53
Figure 3.3	Schematic of Wet Swale	SD-54
Figure 4.1	Typical Grass Channel.....	SD-59
Figure 4.2	Schematic of Grass Channel	SD-59
Figure 5.1	Open Channel Examples	SD-63

Figure 6.1	Alum Treatment System and Injection Equipment.....	SD-67
Figure 7.1	Culvert Flow Conditions	SD-70
Figure 7.2	Culvert Examples	SD-70
Figure 8.1	Example Inlets.....	SD-73
Figure 10.1	Schematic of Dry Detention Basin	SD-81
Figure 10.2	Schematic of Dry Extended Detention Basin	SD-82
Figure 12.1	Example Underground Detention Tank System	SD-89
Figure 12.2	Schematic of Typical Underground Detention Vault	SD-90
Figure 13.1	Schematic of Filter Strip (with Berm)	SD-96
Figure 13.2	Example Problem Sensitivity of Filter Strip Length to Slope and Manning's n Values	SD-98
Figure 14.1	Schematic of Organic Filter.....	SD-101
Figure 15.1	Schematic of Contained Planter Box	SD-104
Figure 15.2	Schematic of Infiltration Planter Box	SD-105
Figure 15.3	Schematic of Flow-Through Planter Box	SD-105
Figure 16.1	Sand Filter Examples	SD-107
Figure 16.2	Surface Sand Filter Volumes	SD-111
Figure 16.3	Perimeter Sand Filter Volumes	SD-112
Figure 16.4	Typical Sand Filter Media Cross Sections	SD-113
Figure 16.5	Surface Sand Filter Perforated Stand-Pipe	SD-114
Figure 16.6	Schematic of Surface Sand Filter	SD-119
Figure 16.7	Schematic of Perimeter Sand Filter	SD-120
Figure 17.1	Schematic of Underground Sand Filter.....	SD-124
Figure 18.1	Schematic of an Example Gravity (Oil-Grit) Separator	SD-128
Figure 19.1	Schematic of Drywell System	SD-132
Figure 20.1	Infiltration Trench Example	SD-134
Figure 20.2	Schematic of Infiltration Trench	SD-142
Figure 20.3	Observation Well Detail	SD-143
Figure 21.1	Schematic of a Soakage Trench.....	SD-148
Figure 22.1	Stormwater Pond Examples	SD-151
Figure 22.2	Typical Stormwater Pond Geometry Criteria	SD-154
Figure 22.3	Typical Pond Outlet Structure	SD-155
Figure 22.4	Schematic of Wet Pond	SD-163
Figure 22.5	Schematic of Wet Extended Detention Pond.....	SD-164
Figure 22.6	Schematic of Micropool Extended Detention Pond	SD-165
Figure 22.7	Schematic of Multiple Pond System	SD-166

Figure 23.1	Green Roof Cross Section (from City of Portland, Oregon).....	SD-173
Figure 24.1	Examples of Modular Porous Pavers.....	SD-177
Figure 24.2	Modular Porous Paver System Section	SD-178
Figure 24.3	Typical Modular Porous Paver System Applications	SD-178
Figure 24.4	Examples of Porous Paver Surfaces	SD-179
Figure 25.1	Porous Concrete System Section	SD-185
Figure 25.2	Porous Concrete System Installation.....	SD-186
Figure 25.3	Typical Porous Concrete System Applications	SD-186
Figure 27.1	Simple Rain Barrel Design (from Maryland DNR Green Building Program).....	SD-192
Figure 27.2	Rain barrels in series	SD-192
Figure 28.1	Stormwater Wetland Examples.....	SD-195
Figure 28.2	Typical Wetland Facility Outlet Structure	SD-202
Figure 28.3	Schematic of Shallow Wetland	SD-208
Figure 28.4	Schematic of Extended Detention Shallow Wetland.....	SD-209
Figure 28.5	Schematic of Pond/Wetland System.....	SD-210
Figure 28.6	Schematic of Pocket Wetland	SD-211
Figure 28.7	Schematics of Submerged Gravel Wetland System.....	SD-212
Figure 29.1	Rolling Meadows Site Plan	SD-216
Figure 29.2	Rolling Meadows Pre-Development Conditions	SD-220
Figure 29.3	Rolling Meadows Post-Development Conditions	SD-221
Figure 29.4	Pond Location on Site	SD-223
Figure 29.5	Plan View of Pond Grading (Not to Scale).....	SD-224
Figure 29.6	Storage-Elevation Table and Curve.....	SD-225
Figure 29.7	Stage-Storage-Discharge Summary	SD-229
Figure 29.8	Profile of Principal Spillway	SD-230
Figure 29.9	Schematic of Riser Detail.....	SD-231
Figure 29.10	Wellington Recreation Center Site Plan.....	SD-232
Figure 29.11	Wellington Recreation Center Pre-Developed Conditions	SD-235
Figure 29.12	Wellington Recreation Center Post-Developed Conditions	SD-236
Figure 29.13	Plan View of Bioretention Facility.....	SD-238
Figure 29.14	Typical Section of Bioretention Facility	SD-238
Figure 29.15	Falcon Creek Community Center Site Plan	SD-240
Figure 29.16	Falcon Creek Community Center Pre-Developed Conditions	SD-243
Figure 29.17	Falcon Creek Community Center Post-Developed Conditions.....	SD-244
Figure 29.18	Available Head Diagram	SD-246

Figure 29.19	Flow Diversion Structure	SD-248
Figure 29.20	Surface Sand Filter Site Plan	SD-250
Figure 29.21	Plan and Profile of Surface Sand Filter	SD-251
Figure 29.22	Perforated Stand Pipe Detail	SD-252
Figure 29.23	Cottonwood Creek Community Center Site Plan.....	SD-253
Figure 29.24	Cottonwood Creek Community Center Pre-Developed Conditions	SD-256
Figure 29.25	Cottonwood Creek Community Center Post-Developed Conditions	SD-257
Figure 29.26	Infiltration Trench Site Plan	SD-261
Figure 29.27	Flow Diversion Structures	SD-262
Figure 29.28	Infiltration Trench Cross Section	SD-264
Figure 29.29	Wellington Recreation Center Site Plan.....	SD-265
Figure 29.30	Wellington Recreation Center Pre-Developed Conditions	SD-267
Figure 29.31	Wellington Recreation Center Post-Developed Conditions	SD-268
Figure 29.32	Enhanced Dry Swale Site Plan	SD-269
Figure 29.33	Control Structure at End of Swale.....	SD-270
Figure 29.34	Trapezoidal Dry Swale Section	SD-271
Figure 29.35	Profile of Northwest Fork Dry Swale	SD-272

1.0 Overview of Stormwater Controls for Site Development

1.1 Stormwater Controls - Categories and Applicability

1.1.1 Introduction

Structural stormwater controls are engineered facilities intended to treat stormwater runoff and/or mitigate the effects of increased stormwater runoff peak rate, volume, and velocity due to urbanization. This section provides an overview of structural stormwater controls that can be used to address the minimum stormwater management standards outlined in [Section 1.1.2](#).

In terms of the *Integrated Design Focus Areas*, a structural stormwater control, or set of structural controls, must:

- **Water Quality:** Remove pollutants in stormwater runoff to protect water quality;
- **Streambank Protection:** Regulate discharge from the site to minimize downstream bank and channel erosion; and
- **Flood Control:** Control conveyance of runoff within and from the site to minimize flood risk to people and properties.

1.1.2 Control Categories

The stormwater control practices recommended in this Manual vary in their applicability and ability to meet stormwater management goals:

Primary Controls

Primary Structural Stormwater Controls have the ability to fully address one or more of the Steps in the *integrated Design Focus Areas* if designed appropriately. Structural controls are recommended for use with a wide variety of land uses and development types. These structural controls have a demonstrated ability to effectively treat the Water Quality Volume (WQ_v) and have been shown to be able to remove 70% to 80% of the annual average total suspended solids (TSS) load in typical post-development urban runoff when designed, constructed, and maintained in accordance with recommended specifications. Several of these structural controls can also be designed to provide primary control for downstream streambank protection (SP_v) and flood control (Q_f). These structural controls are recommended stormwater management facilities for a site wherever feasible and practical.

Secondary Controls

However, a number of structural controls are recommended only for limited use or for special site or design conditions. Generally, these practices either: (1) do not have the ability on their own to fully address one or more of the Steps in the *integrated Design Focus Areas*, (2) are intended to address hotspot or specific land use constraints or conditions, and/or (3) may have high or special maintenance requirements that may preclude their use. These types of structural controls are typically used for *water quality treatment only*. Some of these controls can be used as a pretreatment measure or in series with other structural controls to meet pollutant removal goals. Such structural controls should be considered mostly for commercial, industrial, or institutional developments.

Table 1.1 lists the structural stormwater control practices. These structural controls are recommended for use in a wide variety of applications. A detailed discussion of each of the controls, as well as design criteria and procedures can be found in Sections 2 through 28 of this manual.

Table 1.1 Structural Controls	
Structural Control	Description
Bioretention Areas	<i>Bioretention areas</i> are shallow stormwater basins or landscaped areas which utilize engineered soils and vegetation to capture and treat stormwater runoff. Runoff may be returned to the conveyance system, or allowed to partially exfiltrate into the soil.
Channels <ul style="list-style-type: none"> • Enhanced Swale (Dry, Wet, or Wetland) • Grass Channel (biofilter) 	<ul style="list-style-type: none"> • <i>Enhanced swales</i> are vegetated open channels that are explicitly designed and constructed to capture and treat stormwater runoff within dry or wet cells formed by check dams or other means • <i>Grass channels</i> provide “biofiltering” of stormwater runoff as it flows across the grass surface. However, a grass channel alone cannot meet the 70% TSS removal performance goal. Consequently, grass channels should only be used as pretreatment measure or as part of a treatment train approach.
Chemical Treatment <ul style="list-style-type: none"> • Alum Treatment 	<i>Alum treatment</i> provides for the removal of suspended solids from stormwater runoff entering a wet pond by injecting liquid alum into storm sewer lines on a flow-weighted basis during rain events. Alum treatment should only be considered for large-scale projects where high water quality is desired.
Conveyance Components <ul style="list-style-type: none"> • Culvert • Inlet • Pipe Systems • Energy Dissipators • Open Conveyance Channel 	<ul style="list-style-type: none"> • A <i>culvert</i> is a short, closed (covered) conduit that conveys stormwater runoff under an embankment, usually a roadway. • <i>Inlets</i> are drainage structures used to collect surface water through grate or curb openings and convey it to storm drains or direct outlet to culverts. • <i>Pipe systems</i> are used for transporting runoff from roadway and other inlets to outfalls at structural stormwater controls and receiving waters. <p>Culverts, inlets, and pipe systems alone do not provide water quality treatment.</p>
Detention <ul style="list-style-type: none"> • Dry Detention / Dry Extended Detention Basins • Multi-Purpose Detention Areas • Underground Detention 	<ul style="list-style-type: none"> • <i>Dry detention basins and dry extended detention (ED) basins</i> are surface facilities intended to provide for the temporary storage of stormwater runoff to reduce downstream water quantity impacts. • <i>Multi-purpose detention areas</i> are site areas used for one or more specific activities, such as parking lots and rooftops, which are also designed for the temporary storage of runoff. • <i>Underground detention tanks and vaults</i> are an alternative to surface dry detention for space-limited areas where there is not adequate land for a dry detention basin or multi-purpose detention area.

Table 1.1 Structural Controls	
Structural Control	Description
<p style="text-align: center;">Filtration</p> <ul style="list-style-type: none"> • Filter Strip • Organic Filter • Planter Boxes • Surface Sand Filter/ Perimeter Sand Filter • Underground Sand Filter 	<ul style="list-style-type: none"> • <i>Filter strips</i> provide “biofiltering” of stormwater runoff as it flows across the grass surface. However, filter strips alone cannot meet the 70% TSS removal performance goal. Consequently, filter strips should only be used as pretreatment measure or as part of a treatment train approach. • <i>Organic filters</i> are surface sand filters where organic materials such as a leaf compost or peat/sand mixture are used as the filter media. These media may be able to provide enhanced removal of some contaminants, such as heavy metals. Given their potentially high maintenance requirements, they should only be used in environments that warrant their use. • <i>Planter boxes</i> are used on impervious surfaces in highly urbanized areas to collect and detain / infiltrate rainfall and runoff. The boxes may be prefabricated or constructed in place and contain growing medium, plants, and a reservoir. • <i>Sand filters</i> are multi-chamber structures designed to treat stormwater runoff through filtration, using a sand bed as its primary filter media. Filtered runoff may be returned to the conveyance system, or allowed to partially exfiltrate into the soil. • <i>Underground sand filters</i> are sand filter systems located in an underground vault. These systems should only be considered for extremely high density or space-limited sites.
<p style="text-align: center;">Hydrodynamic Devices</p> <ul style="list-style-type: none"> • Gravity (Oil-Grit) Separator 	<p><i>Hydrodynamic controls</i> use the movement of stormwater runoff through a specially designed structure to remove target pollutants. They are typically used on smaller impervious commercial sites and urban hotspots. These controls typically do not meet the Primary TSS removal performance goal and therefore should only be used as a pretreatment measure and as part of a treatment train approach.</p>
<p style="text-align: center;">Infiltration</p> <ul style="list-style-type: none"> • Downspout Dry Wells • Infiltration Trench • Soakage Trenches 	<ul style="list-style-type: none"> • <i>Downspout dry wells</i> are essentially perforated manholes, but they can be manufactured in various sizes. Located underground, they allow stormwater infiltration even in highly urbanized areas. They should be used in conjunction with some type of pretreatment devices where there are minimal risks of groundwater contamination. • An <i>infiltration trench</i> is an excavated trench filled with stone aggregate used to capture and allow infiltration of stormwater runoff into the surrounding soils from the bottom and sides of the trench. • <i>Soakage trenches</i> are a variation of infiltration trenches. Soakage trenches drain through a perforated pipe buried in gravel. They are used in highly impervious areas where conditions do not allow surface infiltration and where pollutant concentrations in runoff are minimal (i.e. non-industrial rooftops). They may be used in conjunction with other stormwater devices, such as draining downspouts or planter boxes.

Table 1.1 Structural Controls	
Structural Control	Description
<p>Stormwater Ponds</p> <ul style="list-style-type: none"> • Micropool Extended Detention Pond • Multiple Pond Systems • Wet Extended Detention Pond • Wet Pond 	<p><i>Stormwater ponds</i> are constructed stormwater retention basins that have a permanent pool (or micropool) of water. Runoff from each rain event is detained and treated in the pool.</p>
<p>Porous Surfaces</p> <ul style="list-style-type: none"> • Green Roofs • Modular Porous Paver Systems • Porous Concrete 	<ul style="list-style-type: none"> • A <i>green roof</i> uses a small amount of substrate over an impermeable membrane to support a covering of plants. The green roof slows down runoff from the otherwise impervious roof surface as well as moderating rooftop temperatures. With the right plants, a green roof will also provide aesthetic or habitat benefits. • <i>Modular porous paver systems</i> consist of open void paver units laid on a gravel subgrade. Both porous concrete and porous paver systems provide water quality and quantity benefits, but have high workmanship and maintenance requirements, as well as high failure rates. • <i>Porous surfaces</i> are permeable pavement surfaces with an underlying stone reservoir to temporarily store surface runoff before it infiltrates into the subsoil. <i>Porous concrete</i> is the term for a mixture of coarse aggregate, Portland cement, and water that allows for rapid infiltration of water.
<p>Proprietary Systems</p> <ul style="list-style-type: none"> • Commercial Stormwater Controls 	<p><i>Proprietary controls</i> are manufactured structural control systems available from commercial vendors designed to treat stormwater runoff and/or provide water quantity control. Proprietary systems often can be used on small sites and in space-limited areas, as well as in pretreatment applications. However, proprietary systems are often more costly than other alternatives, may have high maintenance requirements, and often lack adequate independent performance data.</p>
<p>Re-Use</p> <ul style="list-style-type: none"> • Rain Harvesting (tanks/barrels) 	<p><i>Rain harvesting</i> is a container or system designed to capture and store rainwater discharged from a roof. The rain harvesting system consists of a storage container, a downspout diversion, a sealed lid, and an overflow system. Typical rain harvesting systems hold between 50 and 500 gallons of water and may work in series to provide larger volumes of storage.</p>
<p>Stormwater Wetlands</p> <ul style="list-style-type: none"> • Extended Detention Shallow Wetland • Pocket Wetland • Pond/Wetland Systems • Shallow Wetland • Submerged Gravel Wetlands 	<ul style="list-style-type: none"> • <i>Stormwater wetlands</i> are constructed wetland systems used for stormwater management. Stormwater wetlands consist of a combination of shallow marsh areas, open water, and semi-wet areas above the permanent water surface. • <i>Submerged gravel wetland systems</i> use wetland plants in submerged gravel or crushed rock media to remove stormwater pollutants. These systems should only be used in mid- to high-density environments where the use of other structural controls may be precluded. The long-term maintenance burden of these systems is uncertain.

1.1.3 Using Other or New Structural Stormwater Controls

Innovative technologies should be allowed and encouraged providing there is sufficient documentation as to their effectiveness and reliability. Communities can allow controls not included in this Manual at their discretion, but should not do so without independently derived information concerning performance, maintenance, application requirements, and limitations.

More specifically, new structural stormwater control designs will not be accepted for inclusion in the manual until independent performance data shows that the structural control conforms to local and/or State criteria for treatment, conveyance, maintenance, and environmental impact.

1.2 Suitability of Stormwater Controls

Some structural stormwater controls are intended to provide water quality treatment for stormwater runoff. Though most of these structural controls provides pollutant removal capabilities, the relative capabilities vary between structural control practices and for different pollutant types.

1.2.1 Water Quality

Pollutant removal capabilities for a given structural stormwater control practice are based on a number of factors including the physical, chemical, and/or biological processes that take place in the structural control and the design and sizing of the facility. In addition, pollutant removal efficiencies for the same structural control type and facility design can vary widely depending on the tributary land use and area, incoming pollutant concentration, flow rate, volume, pollutant loads, rainfall pattern, time of year, maintenance frequency, and numerous other factors.

To assist the designer in evaluating the relative pollutant removal performance of the various structural control options, Table 1.2 provides design removal efficiencies for each of the control practices. It should be noted that these values are *conservative* average pollutant reduction percentages for design purposes derived from sampling data, modeling, and professional judgment. A structural control design may be capable of exceeding these performances, however the values in the table are minimum reasonable values that can be assumed to be achieved when the structural control is sized, designed, constructed, and maintained in accordance with recommended specifications in this Manual.

Where the pollutant removal capabilities of an individual structural stormwater control are not deemed sufficient for a given site application, additional controls may be used in series in a “treatment train” approach. More detail on using structural stormwater controls in series is provided in [Section 1.6](#).

For additional information and data on the range of pollutant removal capabilities for various structural stormwater controls, the reader is referred to the National Pollutant Removal Performance Database (2nd Edition) available at www.cwp.org and the International Stormwater Best Management Practices (BMP) Database at www.bmpdatabase.org

Table 1.2 Design Pollutant Removal Efficiencies for Stormwater Controls (Percentage)

Structural Control	Total Suspended Solids	Total Phosphorus	Total Nitrogen	Fecal Coliform	Metals
Bioretention Areas	80	60	50	---	80
Grass Channel	50	25	20	---	30
Enhanced Dry Swale	80	50	50	---	40
Enhanced Wet Swale	80	25	40	---	20
Alum Treatment	80	80	60	90	75
Filter Strip	50	20	20	---	40
Dry Detention	65	50	30	70	---
Organic Filter	80	60	40	50	75

Table 1.2 Design Pollutant Removal Efficiencies for Stormwater Controls (Percentage)

Structural Control	Total Suspended Solids	Total Phosphorus	Total Nitrogen	Fecal Coliform	Metals
Planter Boxes	80	60	40	50	60
Sand Filters	80	50	25	40	50
Underground Sand Filter	80	50	25	40	50
Gravity (Oil-Grit) Separator	40	5	5	---	---
Downspout Drywell	80	60	60	90	90
Infiltration Trench	80	60	60	90	90
Soakage Trench	80	60	60	90	90
Stormwater Ponds	80	50	30	70*	50
Green Roof	85	---	25	---	95
Modular Porous Paver Systems with infiltration	**	80	80	---	90
Porous Concrete with infiltration	**	50	65	---	60
Proprietary Systems	***	***	***	***	***
Rain Harvesting	---	---	---	---	---
Stormwater Wetlands	80	40	30	70*	50
Submerged Gravel Wetland	80	50	20	70	50

* If no resident waterfowl population present

** Due to the potential for clogging, porous concrete and modular block paver systems should not be used for the removal of sediment or other coarse particulate pollutants

*** The performance of specific proprietary commercial devices and systems must be provided by the manufacturer and should be verified by independent third-party sources and data

--- Insufficient data to provide design removal efficiency

1.2.2 Streambank Protection

These controls have the ability to detain the volume and regulate the discharge of the 1-year, 24-hour storm event to protect natural waterways downstream of the development. Controls that provide streambank protection include detention, energy dissipation, stormwater ponds, stormwater wetlands, and pipe systems.

1.2.3 Flood Control

- **On-Site:** These controls have the ability to safely convey stormwater through a development to minimize the flood risk to persons and property on-site. On-site flood control structures include channels, culverts, detentions, enhanced swales, open conveyance channels, stormwater ponds, conveyance components (inlets and pipe systems), and stormwater wetlands.
- **Downstream:** These controls have the ability to detain the volume and regulate the discharge from the controlling storm event, as determined by downstream assessment, and to minimize flood risk to persons and property downstream of the development. Downstream flood controls include open channels, pipe systems, detention, stormwater ponds, and stormwater wetlands.

1.3 Stormwater Control Selection

1.3.1 Control Screening Process

Outlined below is a screening process for structural stormwater controls which can effectively treat the water quality volume as well as provide water quantity control. This process is intended to assist the site designer and design engineer in the selection of the most appropriate structural controls for a development site, and provides guidance on factors to consider in their location.

In general the following four criteria should be evaluated in order to select the appropriate structural control(s) or group of controls for a development:

- Stormwater Treatment Suitability
- Water Quality Performance
- Site Applicability
- Implementation Considerations

In addition, for a given site, the following factors should be considered and any specific design criteria or restrictions need to be evaluated:

- Physiographic Factors
- Soils
- Special Watershed or Stream Considerations

Finally, environmental regulations should be considered as they may influence the location of a structural control on site, or may require a permit.

The following pages provide a selection process for comparing and evaluating various structural stormwater controls using a screening matrix and a list of location and permitting factors. These tools are provided to assist the design engineer in selecting the subset of structural controls that will meet the stormwater management and design objectives for a development site or project.

Step 1 Overall Applicability

Through the use of the first four screening categories in Table 1.3, the site designer evaluates and screens the overall applicability of the full set of structural controls as well as the constraints of the site in question. The following are the details of the various screening categories and individual characteristics used to evaluate the structural controls.

Stormwater Management Suitability

The first category in the Matrix examines the capability of each structural control option to provide water quality treatment, downstream streambank protection, and flood control. A blank entry means that the structural control cannot or is not typically used to meet an *integrated* Design Focus Areas. This does not necessarily mean that it should be eliminated from consideration, but rather is a reminder that more than one structural control may be needed at a site (e.g., a bioretention area used in conjunction with dry detention storage).

Ability to treat the Water Quality Volume (WQ_v). This indicates whether a structural control provides treatment of the water quality volume (WQ_v). The presence of a “P” or an “S” indicates whether the control is a Primary or Secondary control for meeting the TSS reduction goal.

Ability to provide Streambank Protection (SP_v). This indicates whether the structural control can be used to provide the extended detention of the streambank protection volume (SP_v). The presence of a “P” indicates that the structural control can be used to meet SP_v requirements. An “S” indicates that the structural control may be sized to provide streambank protection in certain situations, for instance on small sites.

Ability to provide Flood Control (Q_f). This indicates whether a structural control can be used to meet the flood control criteria. The presence of a “P” indicates that the structural control can be used to provide peak reduction of the flood mitigation storm event.

Relative Water Quality Performance

The second category of the Matrix provides an overview of the pollutant removal performance of each structural control option, when designed, constructed, and maintained according to the criteria and specifications in this Manual.

Ability to provide TSS and Sediment Removal. This column indicates the capability of a structural control to remove sediment in runoff. All of the Primary structural controls are presumed to remove 70% to 80% of the average annual total suspended solids (TSS) load in typical urban post-development runoff (and a proportional removal of other pollutants).

Ability to provide Nutrient Treatment. This column indicates the capability of a structural control to remove the nutrients nitrogen and phosphorus in runoff, which may be of particular concern with certain downstream receiving waters.

Ability to provide Bacteria Removal. This column indicates the capability of a structural control to remove bacteria in runoff. This capability may be of particular focus in areas with public beaches, shellfish beds, or to meet water regulatory quality criteria under the Total Maximum Daily Load (TMDL) program.

Ability to accept Hotspot Runoff. This last column indicates the capability of a structural control to treat runoff from designated hotspots. Hotspots are land uses or activities which produce higher concentrations of trace metals, hydrocarbons, or other priority pollutants. Examples of hotspots might include: gas stations, convenience stores, marinas, public works storage areas, garbage transfer facilities, material storage sites, vehicle service and maintenance areas, commercial nurseries, vehicle washing/steam cleaning, landfills, construction sites, industrial sites, industrial rooftops, and auto salvage or recycling facilities. A check mark indicates that the structural control may be used on hotspot site; however, it may have specific design restrictions. Please see the specific design criteria of the structural control for more details. Local jurisdictions may have other site uses which they designate as Hotspots, so their criteria should be checked as well.

Site Applicability

The third category of the Matrix provides an overview of the specific site conditions or criteria that must be met for a particular structural control to be suitable. In some cases, these values are recommended values or limits and can be exceeded or reduced with proper design or depending on specific circumstances. Please see the specific criteria section of the structural control for more details.

Drainage Area. This column indicates the approximate minimum or maximum drainage area considered suitable for the structural control practice. If the drainage area present at a site is slightly greater than the maximum allowable drainage area for a practice, some leeway can be permitted if more than one practice can be installed. The minimum drainage areas indicated for ponds and wetlands should not be considered inflexible limits, and may be increased or decreased depending on water availability (baseflow or groundwater), the mechanisms employed to prevent outlet clogging, or design variations used to maintain a permanent pool (e.g., liners).

Space Required (Space Consumed). This comparative index expresses how much space a structural control typically consumes at a site in terms of the approximate area required as a percentage of the impervious area draining to the control.

Slope. This column evaluates the effect of slope on the structural control practice. Specifically, the slope restrictions refer to how flat the area where the facility is installed must be and/or how steep the contributing drainage area or flow length can be.

Minimum Head. This column provides an estimate of the minimum elevation difference needed at a site (from the inflow to the outflow) to allow for gravity operation within the structural control.

Water Table. This column indicates the minimum depth to the seasonally high water table from the bottom or floor of a structural control.

Implementation Considerations

The fourth category in the Matrix provides additional considerations for the applicability of each structural control option.

Residential Subdivision Use. This column identifies whether or not a structural control is suitable for typical residential subdivision development (not including high-density or ultra-urban areas).

Ultra-Urban. This column identifies those structural controls appropriate for use in very high-density (ultra-urban) areas, or areas where space is a premium.

Construction Cost. The structural controls are ranked according to their relative construction cost per impervious acre treated, as determined from cost surveys.

Maintenance. This column assesses the relative maintenance effort needed for a structural stormwater control, in terms of three criteria: frequency of scheduled maintenance, chronic maintenance problems (such as clogging), and reported failure rates. It should be noted that **all structural controls** require routine inspection and maintenance.

Step 2 Specific Criteria

The last three categories in the Structural Control Screening matrix (Table 1.3) provides an overview of various specific design criteria and specifications, or exclusions for a structural control that may be present due to a site's general physiographic character, soils, or location in a watershed with special water resources considerations.

Physiographic Factors

Three key factors to consider are low-relief, high-relief, and karst terrain. In the North Central Texas, low relief (very flat) areas are primarily located east of the Dallas metropolitan area. High relief (steep and hilly) areas are primarily located west of the Fort Worth metropolitan area. Karst and major carbonaceous rock areas are limited to portions of Palo Pinto, Erath, Hood, Johnson, and Somervell counties. Special geotechnical testing requirements may be needed in karst areas. The local reviewing authority should be consulted to determine if a project is subject to terrain constraints.

- Low relief areas need special consideration because many structural controls require a hydraulic head to move stormwater runoff through the facility.
- High relief may limit the use of some structural controls that need flat or gently sloping areas to settle out sediment or to reduce velocities. In other cases, high relief may impact dam heights to the point that a structural control becomes infeasible.
- Karst terrain can limit the use of some structural controls as the infiltration of polluted waters directly into underground streams found in karst areas may be prohibited. In addition, ponding areas may not reliably hold water in karst areas.

Soils

- The key evaluation factors are based on an initial investigation of the NRCS hydrologic soils groups at the site. Note that more detailed geotechnical tests are usually required for infiltration feasibility and during design to confirm permeability and other factors.

Special Watershed or Stream Considerations

- The design of structural stormwater controls is fundamentally influenced by the nature of the downstream water body that will be receiving the stormwater discharge. In addition, the designer should consult with the appropriate review authority to determine if their development project is subject to additional structural control criteria as a result of an adopted local watershed plan or special provision.

Table 1.3 Structural Control Screening Matrix

Category	On-Site Storm Water Controls	STORM WATER TREATMENT SUITABILITY				WATER QUALITY PERFORMANCE				SITE APPLICABILITY					IMPLEMENTATION CONSIDERATIONS					
		Water Quality Protection	Streambank Protection	On-Site Flood Control	Downstream Flood Control	TSS/ Sediment Removal Rate	Nutrient Removal Rate (TP/TN)	Bacteria Removal Rate	Hotspot Application	Drainage Area (acres)	Space Req'd (% of tributary imp. Area)	Site Slope	Minimum Head Required	Depth to Water Table	Residential Subdivision Use	High Density/Ultra Urban	Capital Cost	Maintenance Burden		
Bioretention Areas	Bioretention Areas	P	S	S	-	80%	60%/50%	-	✓	5 max***	5-7%	6% max	5 ft	2 feet	✓	✓	Moderate	Low		
Channels	Enhanced Swales	P	S	S	S	80%	25%/40%	-	✓	5 max	10-20%	4% max	1 ft	below WT	✓		High	Low		
	Channels, Grass	S	S	P	S	50%	25%/20%	-					✓				✓		Low	Moderate
	Channels, Open	-	-	P	S	-	-	-					✓					✓		Low
Chemical Treatment	Alum Treatment System	P	-	-	-	90%	80%/60%	90%	✓	25 min	None				✓	✓	High	High		
Conveyance Components	Culverts	-	-	P	P	-	-	-							✓	✓	Low	Low		
	Energy Dissipation	-	P	S	S	-	-	-							✓	✓	Low	Low		
	Inlets/Street Gutters	-	-	P	-	-	-	-							✓	✓	Low	Low		
	Pipe Systems	-	P	P	P	-	-	-							✓	✓	Low	Low		
Detention	Detention, Dry	S	P	P	P	65%	50%/30%	70%	✓		2 - 3%	15% across pond	6 to 8 ft	2 feet	✓		Low	Moderate to High		
	Detention, Extended Dry	S	P	P	P	65%	50%/30%	70%	✓		2 - 3%	15% across pond	6 to 8 ft	2 feet	✓		Low	Moderate to High		
	Detention, Multi-purpose Areas	-	P	P	P	-	-	-		200 max		1% for Parking Lot; 0.25 in/ft for Rooftop			✓	✓	Low	Low		
	Detention, Underground	-	P	P	P	-	-	-		200 max					✓		High	Moderate		
Filtration	Filter Strips	S	-	-	-	50%	20%/20%	-		2 max***	20-25%	2-6%			✓		Low	Moderate		
	Organic Filters	P	-	-	-	80%	60%/40%	50%	✓	10 max***	2-3%		5 to 8 ft			✓	High	High		
	Planter Boxes	P	-	-	-	80%	60%/40%	-			6%					✓	Low	Moderate		
	Sand Filters, Surface/ Perimeter	P	S	-	-	80%	50%/25%	40%	✓	10 max****/ 2 max***	2-3%	6% max	5 ft/ 2 to 3 ft	2 feet		✓	High	High		
	Sand Filters, Underground	P	-	-	-	80%	50%/25%	40%	✓	5 max	None					✓	High	High		
Hydrodynamic Devices	Gravity (Oil-Grit) Separator	S	-	-	-	40%	5%/5%	-		1 max***	None					✓	High	High		
Infiltration	Downspout Drywell	P	-	-	-	80%	60%/60%	90%							✓	✓	Low	Moderate		
	Infiltration Trenches	P	S	-	-	80%	60%/60%	90%		5 max	2-3%	6% max	1 ft	4 feet	✓	✓	High	High		
	Soakage Trenches	P	S	-	-	80%	60%/60%	90%		5 max	27' per 1000 ft ² impervious area	6% max	1 ft	4 feet	✓	✓	High	High		
Ponds	Wet Pond	P	P	P	P	80%	50%/30%	70%*	✓	25 min**	2-3%	15% max	6 to 8 ft	2 feet, if hotspot or aquifer	✓		Low	Low		
	Wet ED Pond	P	P	P	P	80%	50%/30%	70%*	✓						✓		Low	Low		
	Micropool ED Pond	P	P	P	P	80%	50%/30%	70%*	✓						10 min**	✓		Low	Moderate	
	Multiple ponds	P	P	P	P	80%	50%/30%	70%*	✓						25 min**	✓		Low	Low	
Porous Surfaces	Green Roof	P	S	-	-	85%	95%/16%	-	✓							✓	High	High		
	Modular Porous Paver Systems	S	S	-	-	**	80%/80%	-		5 max	Varies					✓	Moderate	High		
	Porous Concrete	S	S	-	-	**	50%/65%	-		5 max	Varies					✓	High	High		
Proprietary Systems	Proprietary Systems ****	S	S	S	S	****	****	****		****	****				****	✓	High	High		
Re-Use	Rain Harvesting	P	-	-	-	-	-	-							✓	✓	Low	High		
Wetlands	Wetlands, Storm Water	P	P	P	P	80%	40%/30%	70%*	✓	25 min	3-5%	8% max	3 to 5 ft (shallow) 6 to 8 ft (pond)	2 feet, if hotspot or aquifer	✓		Moderate	Moderate		
	Wetlands, Submerged Gravel	P	P	S	-	80%	50%/20%	70%	✓	5 min			2 to 3 ft	below WT	✓	✓	Moderate	High		

Table 1.3 Structural Control Screening Matrix

✓ - Meets suitability criteria

P - Primary Control, meets suitability criteria

S - Secondary Control, can be incorporated into the structural control in certain situations

* Provides less than 80% TSS removal efficiency. May be used in pretreatment and as part of a "treatment train"

** Smaller area acceptable with adequate water balance and anti-clogging device

*** Drainage area can be larger in some instances

**** The application and performance of specific commercial devices and systems must be provided by the manufacturer and should be verified by independent third-party sources and data

1 Porous surfaces provide water quantity benefits by reducing the effective impervious area

2 Due to the potential for clogging, porous surfaces should not be used for the removal of sediment or other coarse particulate pollutants

Category	On-Site Storm Water Controls	PHYSIOGRAPHIC FACTORS			Soils	SPECIAL WATERSHED CONSIDERATIONS		
		Low Relief	High Relief	Karst		High Quality Stream	Aquifer Protection	Reservoir Protection
Bioretention Areas	Bioretention Areas	Several design variations will likely be limited by low head		Use poly-liner or impermeable membrane to seal bottom	Clay or silty soils may require pretreatment	Evaluate for stream warming	Needs to be designed with no exfiltration (i.e. outflow to groundwater)	
Channels	Enhanced Swales	Generally feasible however slope <1% may lead to standing water in dry swales	Often infeasible if slopes are 4% or greater				Hotspot runoff must be adequately treated	Hotspot runoff must be adequately treated
	Channels, Grass Channels, Open							
Chemical Treatment	Alum Treatment System							
Conveyance Components	Culverts							
	Energy Dissipation							
	Inlets/Street Gutters							
	Pipe Systems							
Detention	Detention, Dry		Embankment heights restricted	Require poly or clay liner, Max ponding depth, Geotechnical tests	Underlying soils of hydrologic group "C" or "D" should be adequate to maintain a permanent pool. Most group "A" soils and some group "B" soils will require a pond liner.			
	Detention, Extended Dry							
	Detention, Multi-purpose Areas							
	Detention, Underground			GENERALLY NOT ALLOWED				
Filtration	Filter Strips							
	Organic Filters							
	Planter Boxes				Type A or B			
	Sand Filters, Surface/ Perimeter Sand Filters, Underground	Several design variations will likely be limited by low head		Use poly-liner or impermeable membrane to seal bottom	Clay or silty soils may require pretreatment	Evaluate for stream warming	Needs to be designed with no exfiltration (i.e. outflow to groundwater)	
Hydrodynamic Devices	Gravity (Oil-Grit) Separator							
Infiltration	Downspout Drywell	Minimum distance to water table of 4 feet		GENERALLY NOT ALLOWED	Infiltration rate > 0.5 inch/hr			
	Infiltration Trenches	Minimum distance to water table of 2 feet	Maximum slope of 6% Trenches must have flat bottom	GENERALLY NOT ALLOWED	Infiltration rate > 0.5 inch/hr		Maintain safe distance from wells and water table. No hotspot runoff	Maintain safe distance from bedrock and water table. Pretreat runoff
	Soakage Trenches	Minimum distance to water table of 4 feet	Maximum slope of 6% Trenches must have flat bottom	GENERALLY NOT ALLOWED	Infiltration rate > 0.5 inch/hr			
Ponds	Wet Pond	Limit maximum normal pool depth to about 4 feet (dugout)	Embankment heights restricted	Require poly or clay liner Max ponding depth Geotechnical tests	"A" soils may require pond liner "B" soils may require infiltration testing	Evaluate for stream warming	May require liner if "A" soils are present Pretreat hotspots 2 to 4 ft separation distance from water table	
	Wet ED Pond							
	Micropool ED Pond	Providing pond drain can be problematic						
	Multiple ponds							
Porous Surfaces	Green Roof							
	Modular Porous Paver Systems							
	Porous Concrete							
Proprietary Systems	Proprietary Systems *							
Re-Use	Rain Harvesting							
Wetlands	Wetlands, Storm Water		Embankment heights restricted	Require poly-liner Geotechnical tests	"A" soils may require pond liner	Evaluate for stream warming	May require liner if "A" soils are present Pretreat hotspots 2 to 4 ft separation distance from water table	
	Wetlands, Submerged Gravel							

✓ - Meets suitability criteria
P - Primary Control, meets suitability criteria
S - Secondary Control, can be incorporated into the structural control in certain situations
* Provides less than 80% TSS removal efficiency. May be used in pretreatment and as part of a "treatment train"
** Smaller area acceptable with adequate water balance and anti-clogging device
*** Drainage area can be larger in some instances
**** The application and performance of specific commercial devices and systems must be provided by the manufacturer and should be verified by independent third-party sources and data
1 Porous surfaces provide water quantity benefits by reducing the effective impervious area
2 Due to the potential for clogging, porous surfaces should not be used for the removal of sediment or other coarse particulate pollutants

In some cases, higher pollutant removal or environmental performance is needed to fully protect aquatic resources and/or human health and safety within a particular watershed or receiving water. Therefore, special design criteria for a particular structural control or the exclusion of one or more controls may need to be considered within these watersheds or areas. Examples of important watershed factors to consider include:

High Quality Streams (Streams with a watershed impervious cover less than approximately 15%). These streams may also possess high quality cool water or warm water aquatic resources or endangered species. The design objectives are to maintain habitat quality through the same techniques used for cold-water streams, with the exception that stream warming is not as severe of a design constraint. These streams may also be specially designated by local authorities.

Wellhead Protection. Areas that recharge existing public water supply wells present a unique management challenge. The key design constraint is to prevent possible groundwater contamination by preventing infiltration of hotspot runoff. At the same time, recharge of unpolluted stormwater is encouraged to maintain flow in streams and wells during dry weather.

Reservoir or Drinking Water Protection. Watersheds that deliver surface runoff to a public water supply reservoir or impoundment are a special concern. Depending on the treatment available, it may be necessary to achieve a greater level of pollutant removal for the pollutants of concern, such as bacteria pathogens, nutrients, sediment, or metals. One particular management concern for reservoirs is ensuring stormwater hotspots are adequately treated so they do not contaminate drinking water.

Step 3 Location and Permitting Considerations

In the last step, a site designer assesses the physical and environmental features at the site to determine the optimal location for the selected structural control or group of controls. The checklist below (Table 1.4) provides a condensed summary of current restrictions as they relate to common site features that may be regulated under local, state, or federal law. These restrictions fall into one of three general categories:

- Locating a structural control within an area when expressly prohibited by law.
- Locating a structural control within an area that is strongly discouraged, and is only allowed on a case by case basis. Local, state, and/or federal permits shall be obtained, and the applicant will need to supply additional documentation to justify locating the stormwater control within the regulated area.
- Structural stormwater controls must be setback a fixed distance from a site feature.

This checklist is only intended as a general guide to location and permitting requirements as they relate to siting of stormwater structural controls. Consultation with the appropriate regulatory agency is the best strategy.

Table 1.4 Location and Permitting Checklist	
Site Feature	Location and Permitting Guidance
<p>Jurisdictional Wetland (Waters of the U.S) U.S. Army Corps of Engineers Regulatory Permit</p>	<ul style="list-style-type: none"> • Jurisdictional wetlands should be delineated prior to siting structural control. • Use of natural wetlands for stormwater quality treatment is contrary to the goals of the Clean Water Act and should be avoided. • Stormwater should be treated prior to discharge into a natural wetland. • Structural controls may also be <i>restricted</i> in local buffer zones. Buffer zones may be utilized as a non-structural filter strip (i.e., accept sheet flow). • Should justify that no practical upland treatment alternatives exist. • Where practical, excess stormwater flows should be conveyed away from jurisdictional wetlands.
<p>Stream Channel (Waters of the U.S) U.S. Army Corps of Engineers Section 404 Permit</p>	<ul style="list-style-type: none"> • All Waters of the U.S. (streams, ponds, lakes, etc.) should be delineated prior to design. • Use of any Waters of the U.S. for stormwater quality treatment is contrary to the goals of the Clean Water Act and should be avoided. • Stormwater should be treated prior to discharge into Waters of the U.S. • In-stream ponds for stormwater quality treatment are highly discouraged. • Must justify that no practical upland treatment alternatives exist. • Temporary runoff storage preferred over permanent pools. • Implement measures that reduce downstream warming.
<p>Texas Commission on Environmental Quality Groundwater Management Areas</p>	<ul style="list-style-type: none"> • Conserve, preserve, protect, recharge, and prevent waste of groundwater resources through Groundwater Conservation Districts • Groundwater Conservation District pending for Middle Trinity. • Detailed mapping available from Texas Alliance of Groundwater Districts.
<p>Texas Commission on Environmental Quality Surface Water Quality Standards</p>	<ul style="list-style-type: none"> • Specific stream and reservoir buffer requirements. • May be imperviousness limitations • May be specific structural control requirements. • TCEQ provides water quality certification – in conjunction with 404 permit • Mitigation will be required for imparts to existing aquatic and terrestrial habitat.
<p>100 Year Floodplain Local Stormwater review Authority</p>	<ul style="list-style-type: none"> • Grading and fill for structural control construction is generally discouraged within the 100 year floodplain, as delineated by FEMA flood insurance rate maps, FEMA flood boundary and floodway maps, or more stringent local floodplain maps. • Floodplain fill cannot raise the floodplain water surface elevation by more than limits set by the appropriate jurisdiction.

Site Feature	Location and Permitting Guidance
Stream Buffer Check with appropriate review authority whether stream buffers are required	<ul style="list-style-type: none"> • Consult local authority for stormwater policy. • Structural controls are discouraged in the streamside zone (within 25 feet or more of streambank, depending on the specific regulations).
Utilities Local Review Authority	<ul style="list-style-type: none"> • Call appropriate agency to locate existing utilities prior to design. • Note the location of proposed utilities to serve development. • Structural controls are discouraged within utility easements or rights of way for public or private utilities.
Roads TxDOT or DPW	<ul style="list-style-type: none"> • Consult TxDOT for any setback requirement from local roads. • Consult DOT for setbacks from State maintained roads. • Approval must also be obtained for any stormwater discharges to a local or state-owned conveyance channel.
Structures Local Review Authority	<ul style="list-style-type: none"> • Consult local review authority for structural control setbacks from structures. • Recommended setbacks for each structural control group are provided in the performance criteria in this manual.
Septic Drain fields Local Health Authority	<ul style="list-style-type: none"> • Consult local health authority. • Recommended setback is a minimum of 50 feet from drain field edge or spray area.
Water Wells Local Health Authority	<ul style="list-style-type: none"> • 100-foot setback for stormwater infiltration. • 50-foot setback for all other structural controls.

1.3.2 Example Application

A 20-acre institutional area (e.g., church and associated buildings) is being constructed in a dense urban area within Dallas/Fort Worth metropolitan area. The impervious coverage of the site is 40%. The site drains to an urban stream that is highly impacted from hydrologic alterations (accelerated channel erosion). The stream channel is deeply incised; consequently, flooding is not a problem. The channel drains to an urban river that is tributary to a phosphorus limited drinking water reservoir. Low permeability soils limit infiltration practices.

Objective: Avoid additional disruptions to receiving channel and reduce pollutant loads for sediment and phosphorus to receiving waters.

Target Removals: Provide stormwater management to mitigate for accelerated channel incision and reduce loadings of key pollutants by the following:

- Sediment: 70% to 80%
- Phosphorus: 40%

Activity/Runoff Characteristics: The proposed site is to have large areas of impervious surface in the form of parking and structures. However, there will be a large contiguous portion of turf grass proposed for the front of the parcel that will have a relatively steep slope (approximately 10%) and will drain to the storm drain system associated with the entrance drive. Stormwater runoff from the site is expected to exhibit fairly high sediment levels and seasonally high phosphorus levels (due to turf grass management).

Table 1.5 lists the results of the selection analysis using the screening matrix described previously.

The highlighted rows indicate the controls selected for this example. The **X**'s indicate inadequacies in the control for this site. The **✓**'s indicate adequate control capabilities for this site.

While there is a downstream reservoir to consider, there are no special watershed factors or physiographic factors to preclude the use of any of the practices from the structural control list. However, due to the size of the drainage area, most stormwater ponds and wetlands are removed from consideration. In addition, the site's impermeable soils remove an infiltration trench from being considered. Due to the need to provide flood control as well as streambank protection storage, an extended detention micropool pond will likely be needed, unless some downstream regional storage is available to control flood waters.

To provide additional pollutant removal capabilities in an attempt to better meet the target removals, bioretention, surface sand filters, and/or perimeter sand filters can be used to treat the parking lot and driveway runoff. The bioretention will provide some removal of phosphorus while improving the aesthetics of the site. Surface sand filters provide higher phosphorus removal at a comparable unit cost to bioretention, but are not as aesthetically pleasing. The perimeter sand filter, is a flexible, easy to access practice (but at higher cost) that provides good phosphorus removal and additionally high oil and grease trapping ability.

The site drainage system can be designed so the bioretention and/or sand filters drain to the extended detention micropool pond for redundant treatment. Vegetated dry swales could also be used to convey runoff to the pond, which would provide pretreatment. Pocket wetlands and wet swales were eliminated from consideration due to potential for nuisance conditions. Underground sand filters could also be used at the site; however, cost and aesthetic considerations were significant enough to eliminate from consideration.

Structural Control Alternative	Stormwater Treatment Suitability	Site Applicability	Implementation Considerations	Physiographic Factors/Soils	Special Watershed Considerations	Other Issues
Bioretention	✓ ¹	✓ ²	✓	✓	none	
Dry Swale	✓ ¹	✓ ²	✓	✓	none	
Wet Swale	✓ ¹	✓ ²	✓	✓	none	Odor / mosquitoes
Perimeter Sand Filter	✓ ¹	✓ ²	✓	✓	none	Higher cost
Surface Sand Filter	✓ ¹	✓ ²	✓	✓	none	Aesthetics
Infiltration Trench	✓ ¹	✓	✓	X		
Extended Detention Micropool Pond	✓	✓	✓	✓	none	
Multiple Ponds	✓	X				
Wet Extended Detention Pond	✓	X				
Wet Pond	✓	X				
Extended Detention Shallow Wetland	✓	X				

Structural Control Alternative	Stormwater Treatment Suitability	Site Applicability	Implementation Considerations	Physiographic Factors/Soils	Special Watershed Considerations	Other Issues
Pocket Wetland	✓	✓	✓	✓	none	Odor / mosquitoes
Shallow Wetland	✓	X				

Notes:

1. Only when used with another structural control that provides water quantity control
2. Can treat a portion of the site

1.4 On-Line Versus Off-Line Structural Controls

1.4.1 Introduction

Structural stormwater controls are designed to be either “on-line” or “off-line.” On-line facilities are designed to receive, but not necessarily control or treat, the entire runoff volume above the Q_f up to the peak flood mitigation storm discharge (Q_{p100}). On-line structural controls must be able to handle the entire range of storm flows.

Off-line facilities on the other hand are designed to receive only a specified flow rate or volume through the use of a flow regulator (i.e. diversion structure, flow splitter, etc). Flow regulators are typically used to divert the water quality volume (WQ_v) to an off-line structural control sized and designed to treat and control the WQ_v . After the design runoff flow has been treated and/or controlled, it is returned to the conveyance system. Figure 1.1 shows an example of an off-line sand filter and an on-line enhanced dry swale.

1.4.2 Flow Regulators

Flow regulation to off-line structural stormwater controls can be achieved by either:

- Diverting the water quality volume or other specific maximum flow rate to an off-line structural stormwater control, or
- Bypassing flows in excess of the design flow rate

The peak water quality flow rate (Q_{wq}) can be calculated using the procedure found in [Section 1.4 of the Water Quality Technical Manual](#).

Flow regulators can be flow splitter devices, diversion structures, or overflow structures. A number of examples are shown in Figures 1.2 through 1.4.

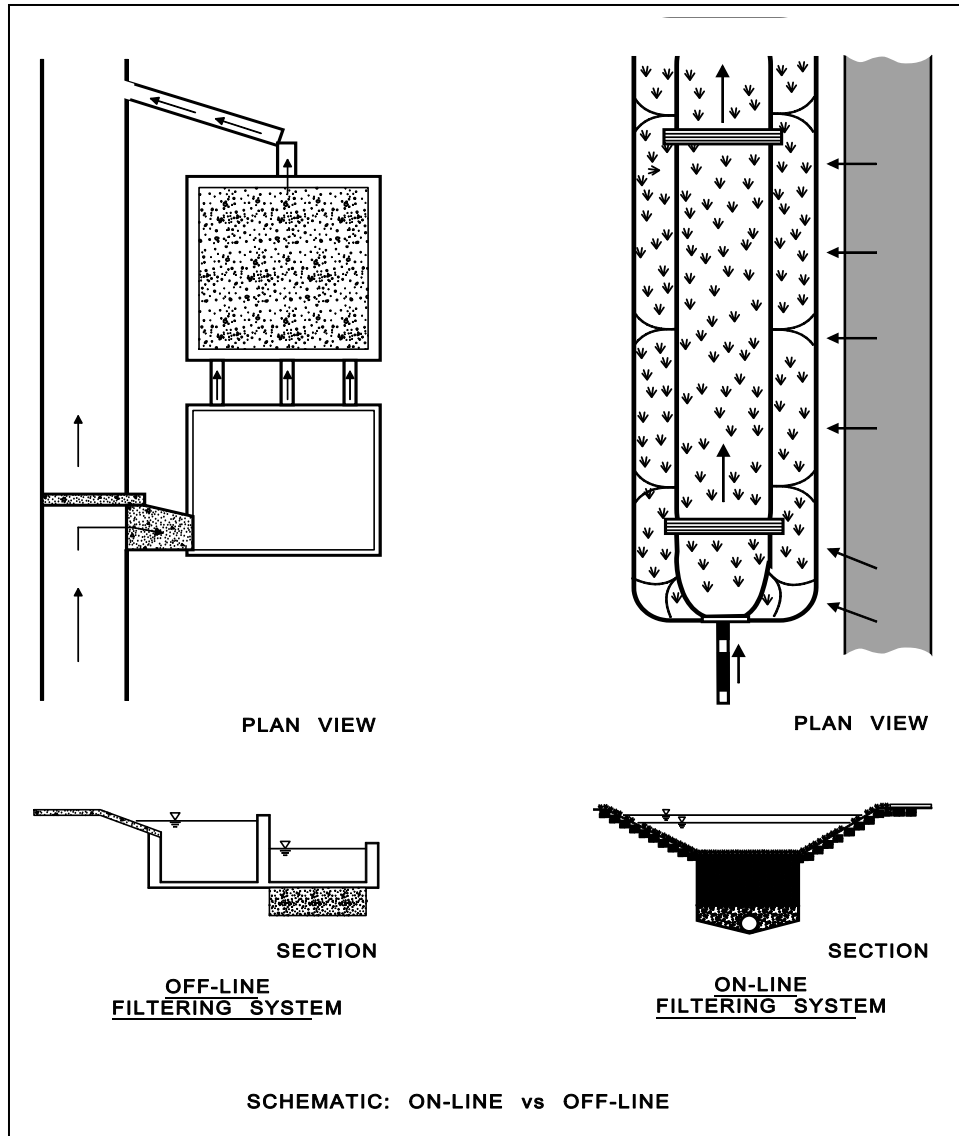

Figure 1.1 Example of On-Line versus Off-Line Structural Controls
 (Source: CWP, 1996)

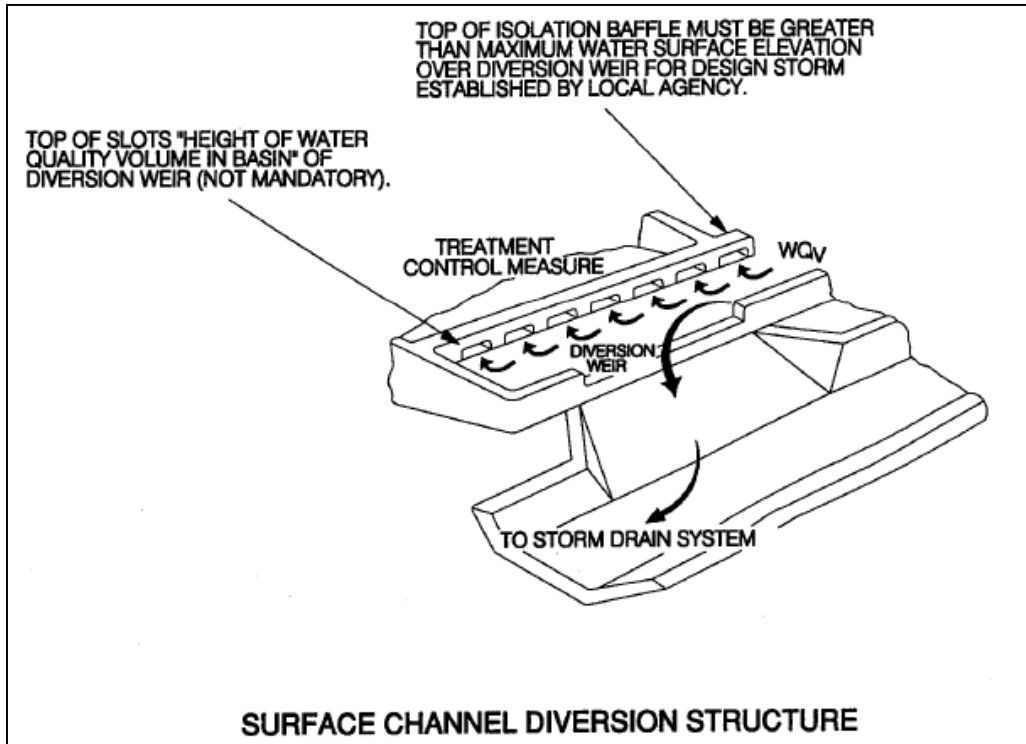

Figure 1.2 Pipe Interceptor Diversion Structure
(Source: City of Sacramento, 2000)

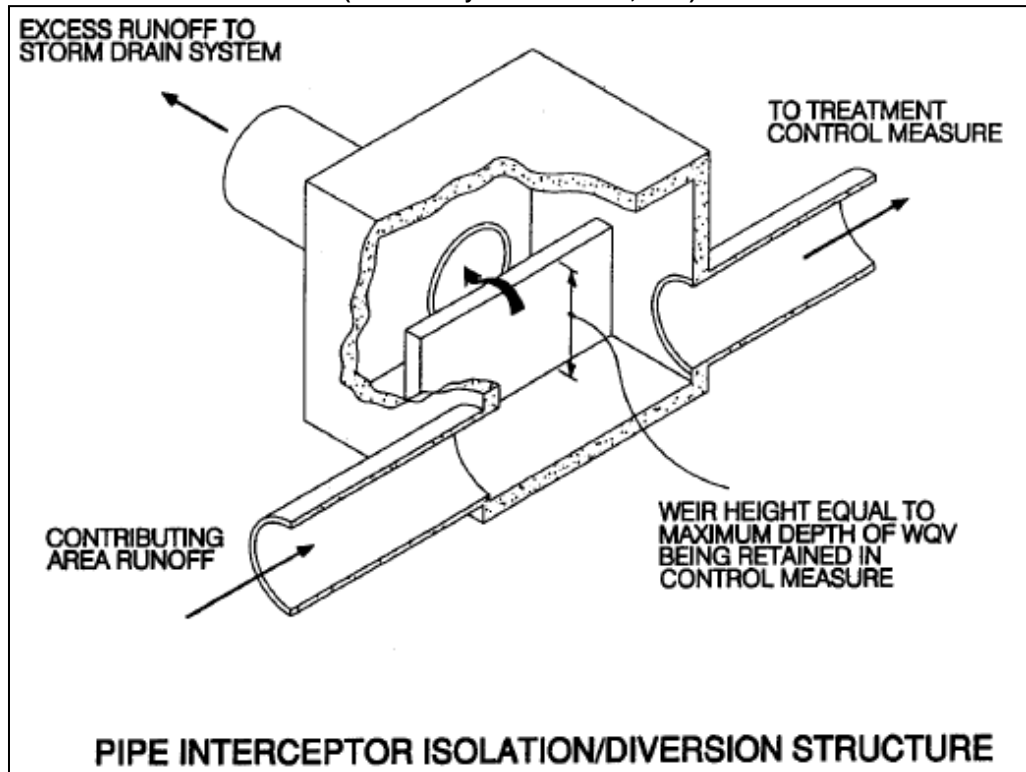

Figure 1.3 Surface Channel Diversion Structure
(Source: City of Sacramento, 2000)

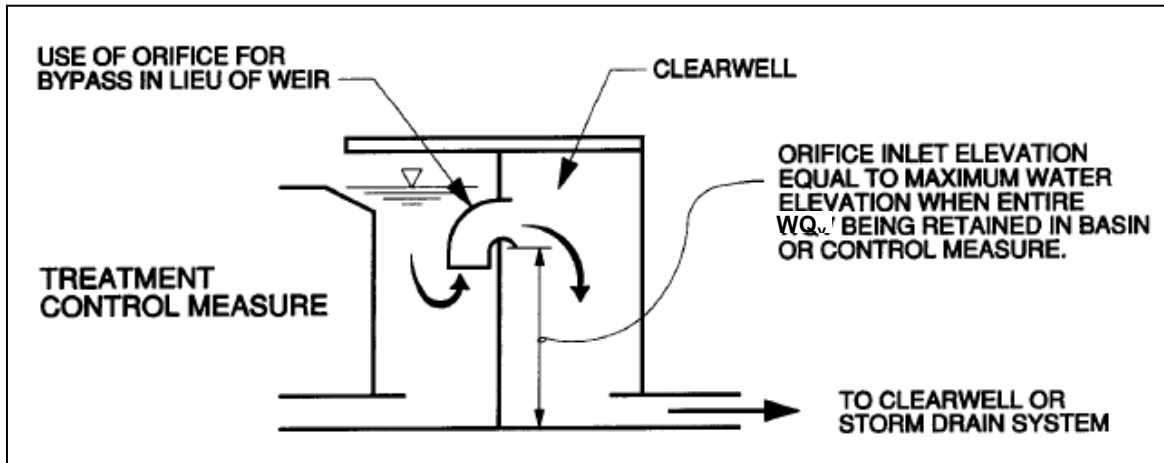

Figure 1.4 Outlet Flow Regulator
(Source: City of Sacramento, 2000)

1.5 Regional Versus On-Site Stormwater Management

1.5.1 Introduction

Using individual, on-site structural stormwater controls for each development is the typical approach for controlling stormwater quantity and quality. The developer finances the design and construction of these controls and, initially, is responsible for all operation and maintenance.

A potential alternative approach is for a community to install a few strategically located regional stormwater controls in a subwatershed rather than require on-site controls (see Figure 1.5). For this Manual, regional stormwater controls are defined as facilities designed to manage stormwater runoff from multiple projects and/or properties through a local jurisdiction-sponsored program, where the individual properties may assist in the financing of the facility, and the requirement for on-site controls is either eliminated or reduced.

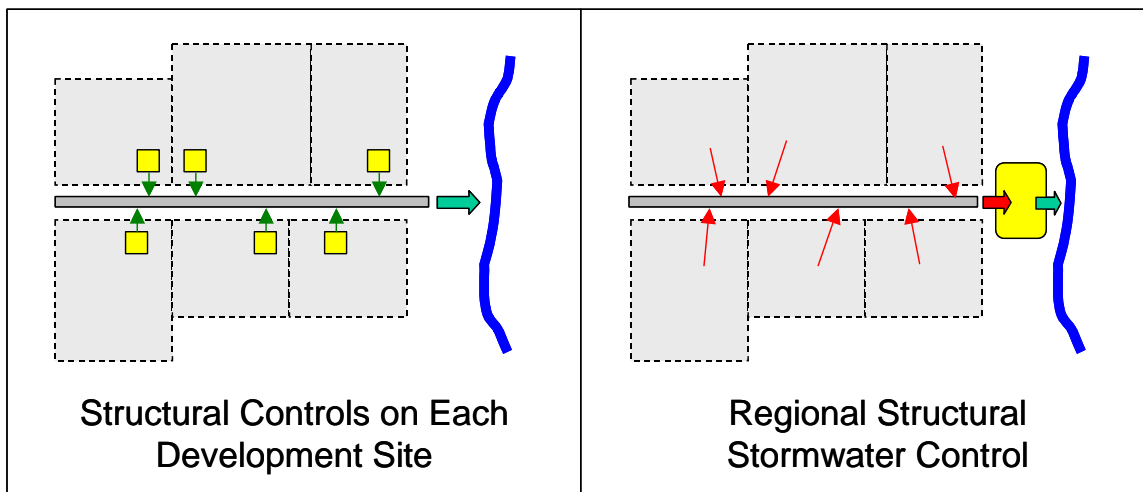

Figure 1.5 On-Site versus Regional Stormwater Management

1.5.2 *Advantages and Disadvantages of Regional Stormwater Controls*

Regional stormwater facilities are significantly more cost-effective because it is easier and less expensive to build, operate, and maintain one large facility than several small ones. Regional stormwater controls are generally better maintained than individual site controls because they are large, highly visible, and typically the responsibility of the local government. In addition, a larger facility poses less of a safety hazard than numerous small ones because it is more visible and is easier to secure.

There are also several disadvantages to regional stormwater controls. In many cases, a community must provide capital construction funds for a regional facility, including the costs of land acquisition. However, if a downstream developer is the first to build, that person could be required to construct the facility and later be compensated by upstream developers for the capital construction costs and annual maintenance expenditures. Conversely, an upstream developer may have to establish temporary control structures if the regional facility is not in place before construction. Maintenance responsibilities generally shift from the homeowner or developer to the local government when a regional approach is selected. The local government would need to establish a stormwater utility or some other program to fund and implement stormwater control. Finally, a large in-stream facility can pose a greater disruption to the natural flow network and is more likely to affect wetlands within the watershed.

Below are summarized some of the “pros” and “cons” of regional stormwater controls.

Advantages of Regional Stormwater Controls

- **Reduced Construction Costs** – Design and construction of a single regional stormwater control facility can be far more cost-effective than numerous individual on-site structural controls.
- **Reduced Operation and Maintenance Costs** – Rather than multiple owners and associations being responsible for the maintenance of several stormwater facilities on their developments, it is simpler and more cost effective to establish scheduled maintenance of a single regional facility.
- **Higher Assurance of Maintenance** – Regional stormwater facilities are far more likely to be adequately maintained as they are large and have a higher visibility, and are typically the responsibility of the local government.
- **Maximum Utilization of Developable Land** – Developers would be able to maximize the utilization of the proposed development for the purpose intended by minimizing the land normally set aside for the construction of stormwater structural controls.
- **Retrofit Potential** – Regional facilities can be used by a community to mitigate existing developed areas that have insufficient or no structural controls for water quality and/or quantity, as well as provide for future development.
- **Other Benefits** – Well-sited regional stormwater facilities can serve as a recreational and aesthetic amenity for a community.

Disadvantages of Regional Stormwater Controls

- **Location and Siting** – Regional stormwater facilities may be difficult to site, particularly for large facilities or in areas with existing development.
- **Capital Costs** – The community must typically provide capital construction funds for a regional facility, including the costs of land acquisition.
- **Maintenance** – The local government is typically responsible for the operation and maintenance of a regional stormwater facility.
- **Need for Planning** – The implementation of regional stormwater controls requires substantial planning, financing, and permitting. Land acquisition must be in place ahead of future projected growth.

For in-stream regional facilities:

- **Water Quality and Streambank Protection** – Without on-site water quality and streambank protection, regional controls do not protect smaller streams upstream from the facility from degradation and streambank erosion.
- **Ponding Impacts** – Upstream inundation from a regional facility impoundment can eliminate floodplains, wetlands, and other habitat.

1.5.3 Important Considerations for the Use of Regional Stormwater Controls

If a community decides to implement a regional stormwater control, then it must ensure that the conveyances between the individual upstream developments and the regional facility can handle the design peak flows and volumes without causing adverse impact or property damage. Fully developed conditions in the regional facility drainage area should be used in the analysis.

Furthermore, unless the system consists of completely man-made conveyances (i.e. storm drains, pipes, concrete channels, etc) the on-site structural controls for water quality and downstream streambank protection will likely be required for all developments within the regional facility's drainage area. Federal water quality provisions do not allow the degradation of water bodies from untreated stormwater discharges, and it is U.S. EPA policy to not allow regional stormwater controls that would degrade stream quality between the upstream development and the regional facility. Further, without adequate streambank protection, aquatic habitats and water quality in the channel network upstream of a regional facility may be degraded by streambank erosion if they are not protected from bankfull flows and high velocities.

Based on these concerns, both the EPA and the U.S. Army Corps of Engineers have expressed opposition to *in-stream* regional stormwater control facilities. In-stream facilities should be avoided if possible and will likely be permitted on a case-by-case basis only.

It is important to note that siting and designing regional facilities should ideally be done within a context of stormwater master planning or watershed planning to be effective.

1.6 Using Structural Stormwater Controls in Series

1.6.1 Stormwater Treatment Trains

The minimum stormwater management standards are an integrated planning and design focus areas whose components work together to limit the adverse impacts of urban development on downstream waters and riparian areas. This approach is sometimes called a stormwater “treatment train.” When considered comprehensively, a treatment train consists of all the design concepts and nonstructural and structural controls that work to attain water quality and quantity goals. This is illustrated in Figure 1.6.



Figure 1.6 Generalized Stormwater Treatment Train

Runoff and Load Generation – The initial part of the “train” is located at the source of runoff and pollutant load generation, and consists of *integrated* site design and pollution prevention practices that reduce runoff and stormwater pollutants from the source.

Pretreatment – The next step in the treatment train consists of pretreatment measures. These measures typically do not provide sufficient pollutant removal to meet the Primary TSS reduction goal, but do provide

calculable water quality benefits that may be applied towards meeting the WQ_v treatment requirement. These measures include:

- The use of stormwater *integrated* site design practices and site design credits to reduce the water quality volume (WQ_v)
- Structural controls that achieve less than the Primary TSS removal rate, but provide pretreatment
- Pretreatment facilities such as sediment forebays

Primary Treatment and/or Quantity Control – The last step is primary water quality treatment and/or quantity (streambank protection and/or flood control) control. This is achieved through the use of either a structural control to achieve both water quality and quantity benefits or a structural control to achieve water quality benefits only.

1.6.2 Use of Multiple Structural Controls in Series

Many combinations of structural controls in series may exist for a site. Figure 1.7 provides a number of hypothetical examples of how the *integrated* Design Focus Areas may be addressed by using structural stormwater controls.

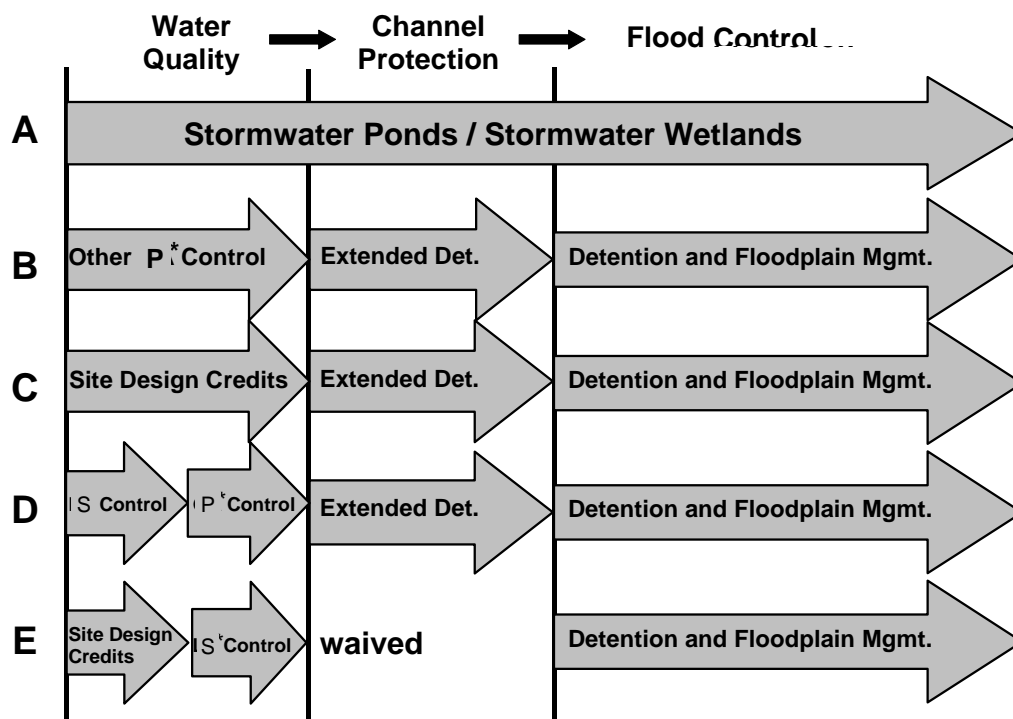

*P - Primary Control and S - Secondary Control Limited Application.

Figure 1.7 Examples of Structural Controls Used in Series

Referring to Figure 1.7 by line letter:

- Two structural controls achieving Primary TSS removal each, *stormwater ponds* and *stormwater wetlands*, can be used to meet all of the requirements of the *integrated* Design Focus Areas in a single facility.
- The other structural controls achieving Primary TSS removal each (*bioretention*, *sand filters*, *infiltration trench* and *enhanced swale*) are typically used in combination with detention controls to meet the

integrated Design Focus Areas. The detention facilities are located downstream from the water quality controls either on-site or combined into a regional or neighborhood facility.

- C. Line C indicates the condition where an environmentally sensitive large lot subdivision has been developed that can be designed so as to waive the water quality treatment requirement altogether. However, detention controls may still be required for downstream streambank protection and flood control.
- D. Where a structural control does not meet the Primary TSS removal criteria, another downstream structural control must be added. For example, urban hotspot land may be fit or retrofit with devices adjacent to parking or service areas designed to remove petroleum hydrocarbons. These devices may also serve as pretreatment devices removing the coarser fraction of sediment. One or more downstream structural controls are then used to meet the full Primary TSS removal goal, and well as water quantity control.
- E. In line E, site design credits have been employed to reduce partially the water quality volume requirement. In this case, for a smaller site, a well designed and tested structural control provides limited TSS removal while a dry detention pond handles the flooding criteria. For this location, direct discharge to a large stream and local downstream floodplain management practices have eliminated the need for streambank protection and flood control storage on site.

The combinations of structural stormwater controls are limited only by the need to employ measures of proven effectiveness and meet local regulatory and physical site requirements. Figures 1.8 through 1.10 illustrate the application of the treatment train concept for: a moderate density residential neighborhood, a small commercial site, and a large shopping mall site.

In Figure 1.8 rooftop runoff drains over grassed yards to backyard grass channels. Runoff from front yards and driveways reaches roadside grass channels. Finally, all stormwater flows to a extended detention micropool stormwater pond.

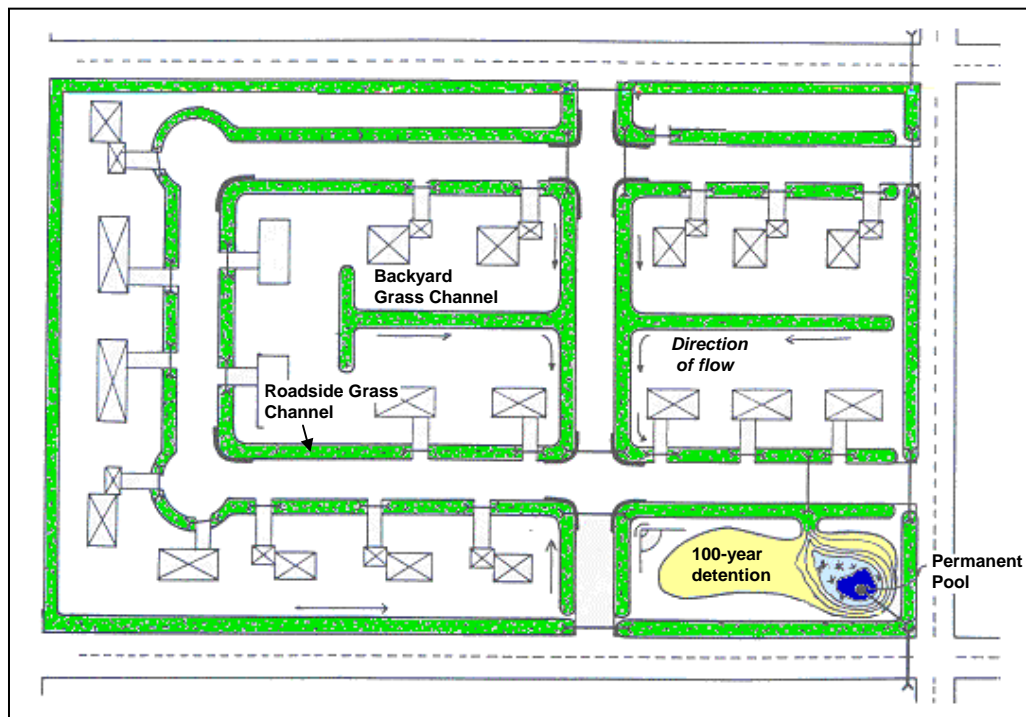

Figure 1.8 Example Treatment Train – Residential Subdivision
(Adapted from: NIPC, 2000)

A gas station and convenience store is depicted in Figure 1.9. In this case, the decision was made to intercept hydrocarbons and oils using a commercial gravity (oil-grit) separator located on the site prior to draining to perimeter sand filter for removal of finer particles and TSS. No stormwater control for streambank protection is required as the system drains to the municipal storm drain pipe system. Flood control is provided by a regional stormwater control downstream.

Figure 1.10 shows an example treatment train for a commercial shopping center. In this case, runoff from rooftops and parking lots drains to depressed parking lot islands, perimeter grass channels, and bioretention areas. Slotted curbs are used at the entrances to these swales to better distribute the flow and to settle out the very coarse particles at the parking lot edge for sweepers to remove. Runoff is then conveyed to an extended detention wet pond for additional pollutant removal and streambank protection. Flood control is provided through parking lot detention.

Figure 1.9 Example Treatment Train – Small Commercial Site

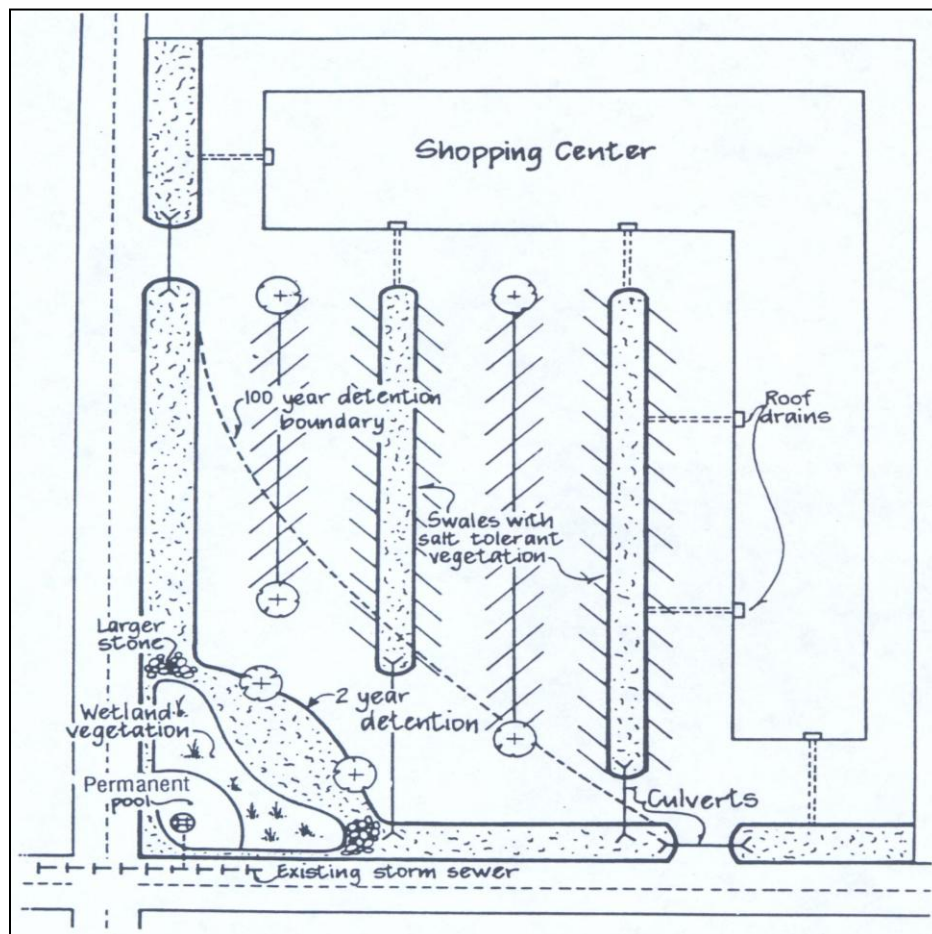
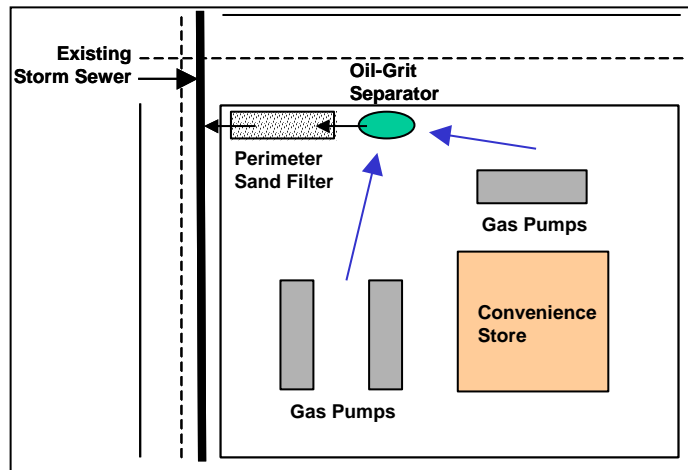

Figure 1.10 Example Treatment Train – Large Commercial Development
(Source: NIPC, 2000)

1.6.3 Calculation of Pollutant Removal for Structural Controls in Series

For two or more structural stormwater controls used in combination, it is often important to have an estimate of the pollutant removal efficiency of the treatment train. Pollutant removal rates for structural controls in series are not additive. For pollutants in particulate form, the actual removal rate (expressed in terms of percentage of pollution removed) varies directly with the pollution concentration and sediment size distribution of runoff entering a facility.

For example, a stormwater pond facility will have a much higher pollutant removal percentage for very turbid runoff than for clearer water. When two stormwater ponds are placed in series, the second pond will treat an incoming particulate pollutant load very different from the first pond. The upstream pond captures the easily removed larger sediment sizes, passing on an outflow with a lower concentration of TSS but with a higher proportion of finer particle sizes. Hence, the removal capability of the second pond for TSS is considerably less than the first pond. Recent findings suggest that the second pond in series can provide as little as half the removal efficiency of the upstream pond.

To estimate the pollutant removal rate of structural controls in series, a method is used in which the removal efficiency of a downstream structural control is reduced to account for the pollutant removal of the upstream control(s). The following steps are used to determine the pollutant removal:

- For each drainage area, list the structural controls in order, upstream to downstream, along with their expected average pollutant removal rates from Table 1.2 for the pollutants of concern.
- For any structural control with a Primary TSS removal rate located downstream from another control that has an equivalent TSS removal rate, the designer should use 50% of the normal pollutant removal rate for the second control in series. For any structural control with a Primary TSS removal rate located downstream from a control that cannot achieve the Primary TSS reduction goal, the designer should use 75% of the normal pollutant removal rate for the second control in series.

For example, if a structural control has a Primary TSS removal rate, then a 35% to 40% TSS removal rate would be assumed for this control if it were placed downstream from another equivalent control in the treatment train (0.5 x 70% to 80%). If it were placed downstream from a structural control that cannot achieve the Primary TSS reduction goal, a 52.5% to 60% TSS removal rate would be assumed (0.75 x 70% to 80%). Use this rule with caution depending on the actual pollutant of concern and make allowance for differences among structural control pollutant removal rates for different pollutants. Actual data from similar situations should be used to temper or override this rule of thumb where available.

- For cases where a structural control which cannot achieve a Primary TSS removal rate is sited upstream from a structural control which can achieve the 70% to 80% removal in the treatment train, the downstream structural control is given full credit for removal of pollutants.
- Apply the following equation for calculation of approximate total accumulated pollution removal for controls in series:

Final Pollutant Removal = (Total load * Control1 removal rate) + (Remaining load * Control2 removal rate) + ... for other Controls in series.

Example

TSS is the pollutant of concern and a commercial device is inserted that has a 20% sediment removal rate. A stormwater pond is designed at the site outlet. A second stormwater pond is located downstream from the first one in series. What is the total TSS removal rate? The following information is given:

Control 1 (Commercial Device) = 20% TSS removal

Control 2 (Stormwater Pond 1) = 80% TSS removal (use 1.0 x design removal rate)

Control 3 (Stormwater Pond 2) = 40% TSS removal (use 0.5 x design removal rate)

Then applying the controls in order and working in terms of “units” of TSS starting at 100 units:

For Control 1: 100 units of TSS * 20% removal rate = 20 units removed
100 units - 20 units removed = 80 units of TSS remaining

For Control 2: 80 units of TSS * 80% removal rate = 64 units removed
80 units - 64 units removed = 16 units of TSS remaining

For Control 3: 16 units of TSS * 40% removal rate = 6 units removed
16 units - 6 units removed = 10 units TSS remaining

For the treatment train in total = 100 units TSS – 10 units TSS remaining = **90% removal**

1.6.4 Routing with WQ_v Removed

When off-line structural controls such as bioretention areas, sand filters and infiltration trenches capture and remove the water quality volume (WQ_v), downstream structural controls do not have to account for this volume during design. That is, the WQ_v may be subtracted from the total volume that would otherwise need to be routed through the downstream structural controls.

From a calculation standpoint this would amount to removing the initial WQ_v from the beginning of the runoff hydrograph – thus creating a “notch” in the runoff hydrograph. Since most commercially available hydrologic modeling packages cannot handle this type of action, the following method to adjust “CN” values has been created to facilitate removal from the runoff hydrograph of approximately the WQ_v :

- Enter the horizontal axis on Figure 1.11 with the impervious percentage of the watershed and read upward to the predominant soil type (interpolation between curves is permitted)
- Read left to the factor
- Multiply the curve number for the sub-watershed that includes the water quality basin by this factor – this provides a smaller curve number

The difference in curve number will generate a runoff hydrograph that has a volume less than the original volume by an amount approximately equal to the WQ_v . This method should be used only for bioretention areas, filter facilities, and infiltration trenches where the drawdown time is ≥ 24 hours.

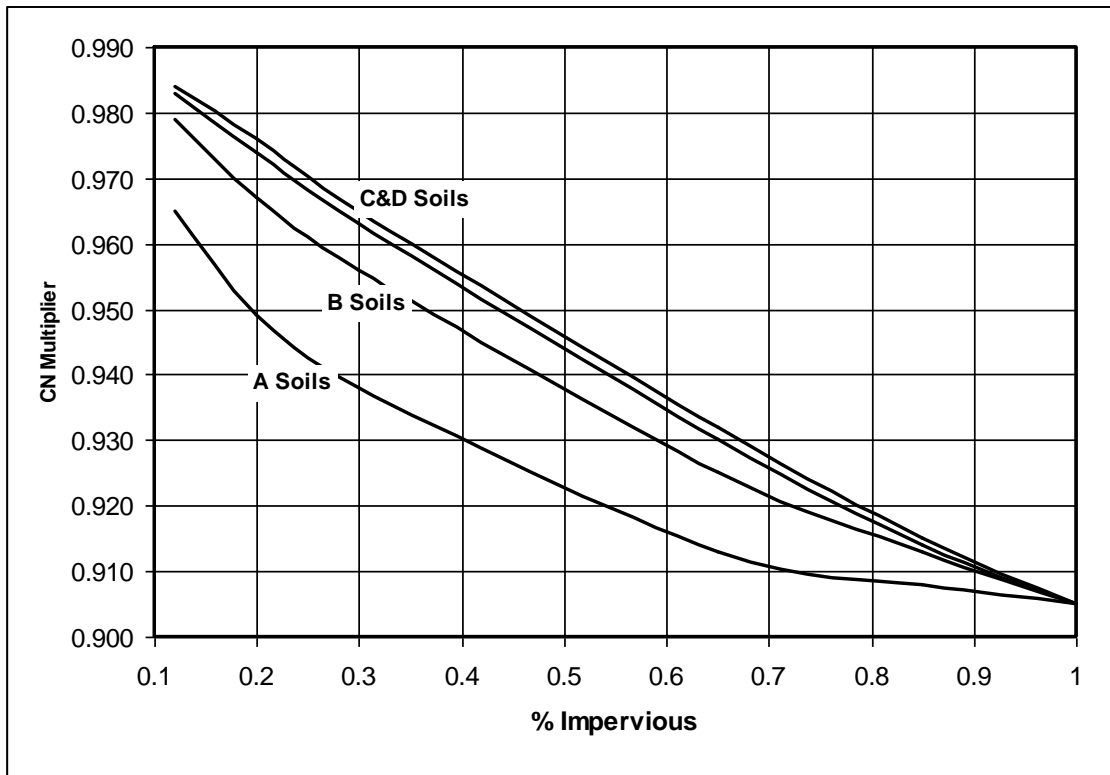

Figure 1.11 Curve Number Adjustment Factor

Example

A site design employs an infiltration trench for the WQ_v, and has a curve number of 72, is B type soil, and has an impervious percentage of 60%, the factor from Figure 1.11 is 0.93. The curve number to be used in calculation of a runoff hydrograph for the quantity controls would be: $(72 \times 0.93) = 67$.

2.0 Bioretention

Structural Stormwater Control



Description: Shallow stormwater basin or landscaped area that utilizes engineered soils and vegetation to capture and treat runoff.

KEY CONSIDERATIONS

DESIGN CRITERIA:

- Maximum contributing drainage area of 5 acres (< 2 acres recommended)
- Often located in “landscaping islands”
- Treatment area consists of grass filter, sand bed, ponding area, organic/mulch layer, planting soil, and vegetation
- Typically requires 5 feet of head

ADVANTAGES / BENEFITS:

- Applicable to small drainage areas
- Good for highly impervious areas, flexible siting
- Good retrofit capability
- Relatively low maintenance requirements
- Can be planned as an aesthetic feature

DISADVANTAGES / LIMITATIONS:

- Requires extensive landscaping if in public area
- Not recommended for areas with steep slopes

MAINTENANCE REQUIREMENTS:

- Inspect and repair/replace treatment area components

STORMWATER MANAGEMENT SUITABILITY

P Water Quality Protection

S Streambank Protection

S On-Site Flood Control

S Downstream Flood Control

Accepts Hotspot Runoff: Yes
(requires impermeable liner)

S - in certain situations

IMPLEMENTATION CONSIDERATIONS

M Land Requirement

M Capital Cost

L Maintenance Burden

Residential Subdivision Use: Yes

High Density/Ultra-Urban: Yes

Drainage Area: 5 acres max. (< 2 acres recommended)

Soils: Planting soils must meet specified criteria; No restrictions on surrounding soils

Other Considerations: Use of native plants is recommended

L=Low M=Moderate H=High

POLLUTANT REMOVAL

<input checked="" type="checkbox"/> 80%	Total Suspended Solids
<input checked="" type="checkbox"/> 60/50%	Nutrients - Total Phosphorus / Total Nitrogen removal
<input checked="" type="checkbox"/> M	Metals - Cadmium, Copper, Lead, and Zinc removal
<input checked="" type="checkbox"/> No Data	Pathogens - Coliform, Streptococci, E. Coli removal

2.1 General Description

Bioretention areas (also referred to as *bioretention filters* or *rain gardens*) are structural stormwater controls that capture and temporarily store the water quality protection volume (WQ_v) using soils and vegetation in shallow basins or landscaped areas to remove pollutants from stormwater runoff.

Bioretention areas are engineered facilities in which runoff is conveyed as sheet flow to the “treatment area” which consists of a grass buffer strip, ponding area, organic or mulch layer, planting soil, and vegetation. An optional sand bed can also be included in the design to provide aeration and drainage of the planting soil. The filtered runoff is typically collected and returned to the conveyance system, though it can also infiltrate into the surrounding soil in areas with porous soils.

There are numerous design applications, both on- and off-line, for bioretention areas. These include use on single-family residential lots (*rain gardens*), as off-line facilities adjacent to parking lots, along highway and road drainage swales, within larger landscaped pervious areas, and as landscaped islands in impervious or high-density environments. Figures 2.1 and 2.2 illustrate a number of examples of bioretention facilities in both photographs and drawings.



Figure 2.1 Bioretention Area Examples

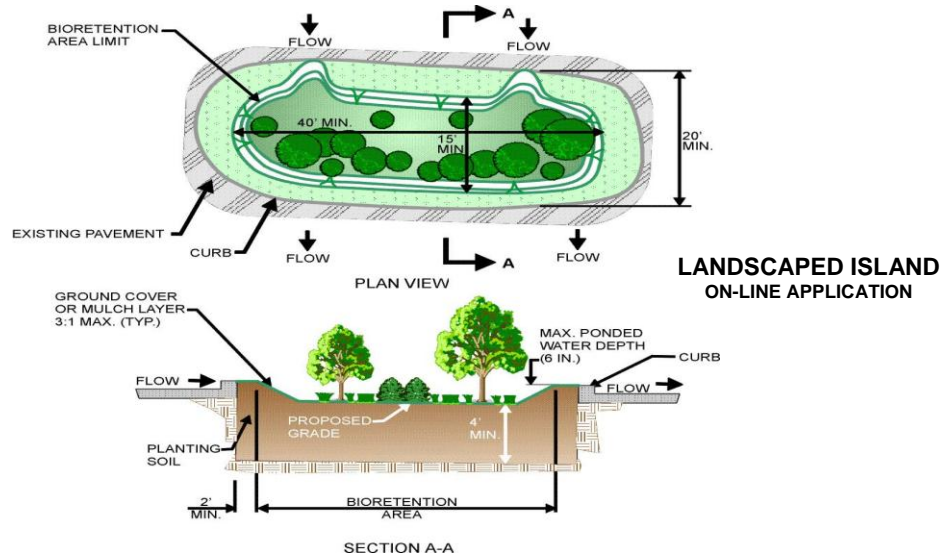
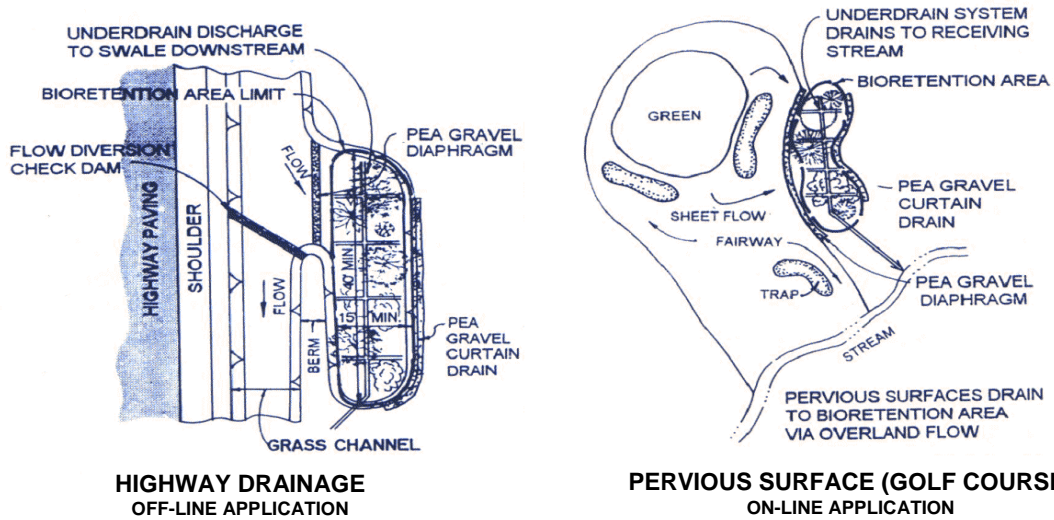
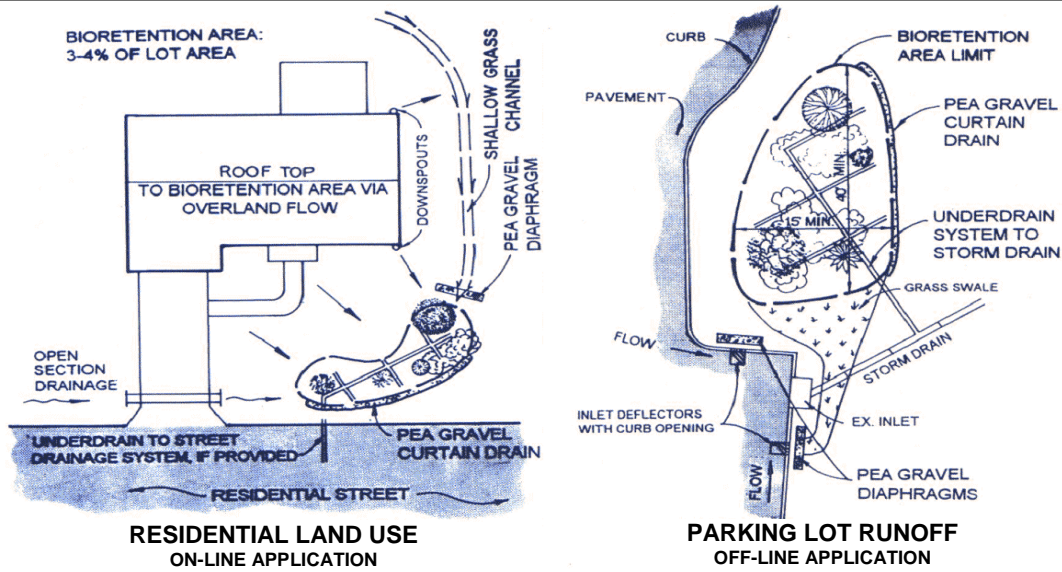

Figure 2.2 Bioretention Area Applications

(Source: Claytor and Schueler, 1996)

2.2 Stormwater Management Suitability

Bioretention areas are designed primarily for stormwater quality, i.e. the removal of stormwater pollutants. Bioretention can provide limited runoff quantity control, particularly for smaller storm events. These facilities may sometimes be used to partially or completely meet streambank protection requirements on smaller sites. However, bioretention areas will typically need to be used in conjunction with another structural control to provide streambank protection as well as flood control. It is important to ensure that a bioretention area safely bypasses higher flows.

Water Quality Protection

Bioretention is an excellent stormwater treatment practice due to the variety of pollutant removal mechanisms. Each of the components of the bioretention area is designed to perform a specific function (see Figure 2.3 of this section). The *grass filter strip (or grass channel)* reduces incoming runoff velocity and filters particulates from the runoff. The *ponding area* provides for temporary storage of stormwater runoff prior to its evaporation, infiltration, or uptake and provides additional settling capacity. The *organic or mulch layer* provides filtration as well as an environment conducive to the growth of microorganisms that degrade hydrocarbons and organic material. The *planting soil* in the bioretention facility acts as a filtration system, and clay in the soil provides adsorption sites for hydrocarbons, heavy metals, nutrients, and other pollutants. Both *woody and herbaceous plants* in the ponding area provide vegetative uptake of runoff and pollutants and also serve to stabilize the surrounding soils. Finally, an optional *sand bed* provides for positive drainage and aerobic conditions in the planting soil and provides a final polishing treatment media.

Section 2.3 gives data on pollutant removal efficiencies that can be used for planning and design purposes.

Streambank Protection

For smaller sites, a bioretention area may be designed to capture the entire streambank protection volume SP_v in either an off- or on-line configuration. Given that a bioretention facility is typically designed to completely drain over 48 hours, the requirement of extended detention of the 1-year, 24-hour storm runoff volume will be met. For larger sites where only the WQ_v is diverted to the bioretention facility, another structural control must be used to provide SP_v extended detention.

Flood Control

Bioretention areas must provide flow diversion and/or be designed to safely pass extreme storm flows and protect the ponding area, mulch layer, and vegetation.

Credit for the volume of runoff removed and treated in the bioretention area may be taken in flood control calculations (see Section 1.0).

2.3 Pollutant Removal Capabilities

Bioretention areas are presumed to be able to remove 80% of the total suspended solids load in typical urban post-development runoff when sized, designed, constructed, and maintained in accordance with the recommended specifications. Undersized or poorly designed bioretention areas can reduce TSS removal performance.

The following design pollutant removal rates are conservative average pollutant reduction percentages for design purposes derived from sampling data, modeling, and professional judgment. In a situation where a removal rate is not deemed sufficient, additional controls may be put in place at the given site in a series or “treatment train” approach.

- Total Suspended Solids – 80%
- Total Phosphorus – 60%
- Total Nitrogen – 50%

- Fecal Coliform – insufficient data
- Heavy Metals – 80%

For additional information and data on pollutant removal capabilities for bioretention areas, see the National Pollutant Removal Performance Database (2nd Edition) available at www.cwp.org and the National Stormwater Best Management Practices (BMP) Database at www.bmpdatabase.org

2.4 Application and Site Feasibility Criteria

Bioretention areas are suitable for many types of development, from single-family residential to high-density commercial projects. Bioretention is also well suited for small lots, including those of one acre or less. Because of its ability to be incorporated in landscaped areas, the use of bioretention is extremely flexible. Bioretention areas are an ideal structural stormwater control for use as roadway median strips and parking lot islands and are also good candidates for the treatment of runoff from pervious areas, such as a golf course. Bioretention can also be used to retrofit existing development with stormwater quality treatment capacity.

The following criteria should be evaluated to ensure the suitability of a bioretention area for meeting stormwater management objectives on a site or development.

General Feasibility

- Suitable for Residential Subdivision Usage – YES
- Suitable for High Density/Ultra Urban Areas – YES
- Regional Stormwater Control – NO
- Hot Spot - YES

Physical Feasibility - Physical Constraints at Project Site

- Drainage Area – 5 acres maximum; 0.5 to 2 acres are preferred.
- Space Required – Approximately 5-7% of the tributary impervious area is normally required.
- Site Slope – No more than 6% slope
- Minimum Head – Elevation difference needed at a site from the inflow to the outflow: 3-5 feet
- Minimum Depth to Water Table – A separation distance of 2 feet recommended between the bottom of the bioretention facility and the elevation of the seasonally high water table.
- Soils – No restrictions; engineered media required

Other Constraints / Considerations

- Aquifer Protection – Do not allow infiltration of filtered hotspot runoff into groundwater

2.5 Planning and Design Criteria

*The following criteria are to be considered **minimum** standards for the design of a bioretention facility. Consult with the local review authority to determine if there are any variations to these criteria or additional standards that must be followed.*

2.5.1 Location and Siting

- Bioretention areas should have a maximum contributing drainage area of 5 acres or less; 0.5 to 2 acres are preferred. Multiple bioretention areas can be used for larger areas.
- Bioretention areas can either be used to capture sheet flow from a drainage area or function as an off-line device. On-line designs should be limited to a maximum drainage area of 0.5 acres unless special precautions are taken to protect from erosion during high flows.

- When used in an off-line configuration, the water quality protection volume (WQ_v) is diverted to the bioretention area through the use of a flow splitter. Stormwater flows greater than the WQ_v are diverted to other controls or downstream (see [Section 1.4.2](#) for more discussion of off-line systems and design guidance for diversion structures and flow splitters).
- Bioretention systems are designed for intermittent flow and must be allowed to drain and re-aerate between rainfall events. They should not be used on sites with a continuous flow from groundwater, sump pumps, or other sources.
- Bioretention area locations should be integrated into the site planning process, and aesthetic considerations should be taken into account in their siting and design. Elevations must be carefully worked out to ensure that the desired runoff flow enters the facility with no more than the maximum design depth.

2.5.2 General Design

- A well-designed bioretention area consists of:
 - Grass filter strip (or grass channel) between the contributing drainage area and the ponding area, except where site conditions preclude its use,
 - Ponding area containing vegetation with a planting soil bed,
 - Organic/mulch layer,
 - Pea gravel layer between the planting soil and the gravel underneath to provide filtering of the particles prior to entering gravel layer,
 - Gravel and perforated pipe underdrain system to collect runoff that has filtered through the soil layers (bioretention areas can optionally be designed to infiltrate into the soil – see description of infiltration trenches for infiltration criteria).
- A bioretention area design will also include some of the following:
 - 1 Optional **sand filter layer** to spread flow, filter runoff, and aid in aeration and drainage of the planting soil.
 - 2 **Stone diaphragm** at the beginning of the grass filter strip to reduce runoff velocities and spread flow into the grass filter.
 - 3 **Inflow diversion** or an **overflow structure** consisting of one of five main methods:
 - Use a flow diversion structure
 - For curbed pavements use an inlet deflector (see Figure 2.6).
 - Use a slotted curb and design the parking lot grades to divert the WQ_v into the facility. Bypass additional runoff to a downstream catch basin inlet. Requires temporary ponding in the parking lot (see Figure 2.5).
 - Figure 2.2 illustrates the use of a short deflector weir (maximum height 6 inches) designed to divert the maximum water quality peak flow into the bioretention area.
 - An in-system overflow consisting of an overflow catch basin inlet and/or a pea gravel curtain drain overflow.

See Figure 2.3 for an overview of the various components of a bioretention area. Figure 2.4 provides a plan view and profile schematic of an on-line bioretention area. An example of an off-line facility is shown in Figure 2.5.

2.5.3 Physical Specifications / Geometry

- Recommended minimum dimensions of a bioretention area are 10 feet wide by 40 feet long. All designs except small residential applications should maintain a length to width ratio of at least 2:1.
- The planting soil filter bed is sized using a Darcy's Law equation with a filter bed drain time of less than 48 hours (less than 6 hours residential neighborhoods and 24 hours non-residential preferred) and a coefficient of permeability (k) of greater than 0.5 ft/day.
- The maximum recommended ponding depth of the bioretention areas is 6 inches with a drain time normally of 3 to 4 hours in residential settings.
- The planting soil bed must be at least 2.5 feet in depth and up to 4 feet if large trees are to be planted. Planting soils should be sandy loam, loamy sand, or loam texture with a clay content ranging from 5 to 8%. The soil must have an infiltration rate of at least 0.5 inches per hour (1.0 in/hr preferred) and a pH between 5.5 and 6.5. In addition, the planting soil should have a 1.5 to 3% organic content and a maximum 500 ppm concentration of soluble salts.
- For on-line configurations, a grass filter strip with a pea gravel diaphragm is typically utilized (see Figure 2.3) as the pretreatment measure. The required length of the filter strip depends on the drainage area, imperviousness, and the filter strip slope. Design guidance on filter strips for pretreatment can be found in [Section 13.0 \(Filter Strip\)](#).
- For off-line applications, a grass channel with a pea gravel diaphragm flow spreader is used for pretreatment. The length of the grass channel depends on the drainage area, land use, and channel slope. The minimum grassed channel length should be 20 feet. Design guidance on grass channels for pretreatment can be found in [Section 4.0 \(Grass Channel\)](#).
- The mulch layer should consist of 2 to 4 inches of commercially available fine shredded hardwood mulch or shredded hardwood chips.
- The sand bed (optional) should be 12 to 18 inches thick. Sand should be clean and have less than 15% silt or clay content.
- Pea gravel for the 4" to 9" thick layer above the gravel bedding (and diaphragm and curtain, where used), should be ASTM D 448 size No. 6 ($\frac{1}{8}$ " to $\frac{1}{4}$ ").
- The underdrain collection system is equipped with a 6-inch perforated PVC pipe (AASHTO M 252) in an 8-inch gravel layer. The pipe should have 3/8-inch perforations, spaced at 6-inch centers, with a minimum of 4 holes per row. The pipe is spaced at a maximum of 10 feet on center and a minimum grade of 0.5% must be maintained.
- A narrow 24" wide permeable filter fabric is placed between the gravel layer and the pea gravel layer directly above the perforated pipes to limit piping of soil directly into the pipe. Filter fabric is also placed along the vertical or sloping outer walls of the bioretention system to limit vertical infiltration prior to filtration through the soil.

2.5.4 Pretreatment / Inlets

- Adequate pretreatment and inlet protection for bioretention systems is provided when all of the following are provided: (a) grass filter strip below a level spreader, or grass channel, (b) pea gravel diaphragm and (c) an organic or mulch layer.

2.5.5 Outlet Structures

- Outlet pipe is to be provided from the underdrain system to the facility discharge. Due to the slow rate of filtration, outlet protection is generally unnecessary.

2.5.6 Emergency Spillway

- An overflow structure and nonerosive overflow channel must be provided to safely pass flows from the bioretention area that exceeds the storage capacity to a stabilized downstream area or watercourse. If the system is located off-line, the overflow should be set above the shallow ponding limit.
- The high flow overflow system within the structure consists of a yard drain catch basin (Figure 2.3), though any number of conventional systems could be used. The throat of the catch basin inlet is normally placed 6 inches above the mulch layer. It should be designed as a domed grate or a covered weir structure to avoid clogging with floatation mulch and debris, and should be located at a distance from inlets to avoid short circuiting of flow. It may also be placed into the side slope of the structure maintaining a neat contoured appearance.

2.5.7 Maintenance Access

- Adequate access must be provided for all bioretention facilities for inspection, maintenance, and landscaping upkeep. Appropriate equipment and vehicles are essential.

2.5.8 Safety Features

- Bioretention areas generally do not require any special safety features. Fencing of bioretention facilities is not generally desirable.

2.5.9 Landscaping

- Landscaping is critical to the performance and function of bioretention areas.
- A dense and vigorous vegetative cover should be established over the contributing pervious drainage areas before runoff can be accepted into the facility. Side slopes should be sodded to limit erosion of fine particles onto the bioretention surface.
- The bioretention area should be vegetated to resemble a terrestrial forest ecosystem, with a mature tree canopy, subcanopy of understory trees, scrub layer, and herbaceous ground cover. Three species each of both trees and scrubs are recommended to be planted.
- The tree-to-shrub ratio should be 2:1 to 3:1. On average, the trees should be spaced 8 feet apart. Plants should be placed at regular intervals to replicate a natural forest. Woody vegetation should not be specified at inflow locations.
- After the trees and shrubs are established, the ground cover and mulch should be established.
- Choose plants based on factors such as whether native or not, resistance to drought and inundation, cost aesthetics, maintenance, etc. Planting recommendations for bioretention facilities are as follows:
 - Native plant species should be specified over non-native species.
 - Vegetation should be selected based on a specified zone of hydric tolerance.
 - A selection of trees with an understory of shrubs and herbaceous materials should be provided.

Additional information and guidance on the appropriate woody and herbaceous species appropriate for bioretention in North Central Texas, and their planting and establishment, can be found in [Section 1.5.2 of the Landscape Technical Manual](#).

2.5.10 Additional Site-Specific Design Criteria and Issues

Physiographic Factors - Local terrain design constraints

- Low Relief – Use of bioretention areas may be limited by low head

- High Relief – Ponding area surface must be relatively level
- Karst – Use poly-liner or impermeable membrane to seal bottom

Soils

- No restrictions

Special Downstream Watershed Considerations

- Aquifer Protection – No restrictions, if designed with no infiltration (i.e. outflow to groundwater)

2.6 Design Procedures

Step 1 Compute runoff control volumes from the *integrated* Design Focus Areas

Calculate the Water Quality Protection Volume (WQ_v), Streambank Protection Volume (SP_v), and the flood mitigation storm Flood Discharge (Q_f).

Details on the *integrated* Design Focus Areas are found in *Section 1.0 of the Planning Technical Manual*.

Step 2 Determine if the development site and conditions are appropriate for the use of a bioretention area

Consider the Application and Site Feasibility Criteria in *Sections 2.4 and 2.5* (Location and Siting).

Step 3 Confirm local design criteria and applicability

Consider any special site-specific design conditions/criteria from *Section 2.5.10* (Additional Site-Specific Design Criteria and Issues).

Check with local officials and other agencies to determine if there are any additional restrictions and/or surface water or watershed requirements that may apply.

Step 4 Compute WQ_v peak discharge (Q_{wq})

The peak rate of discharge for water quality design storm is needed for sizing of off-line diversion structures (see *Section 1.4 of the Water Quality Technical Manual*).

- Using WQ_v (or total volume to be captured), compute CN
- Compute time of concentration using TR-55 method
- Determine appropriate unit peak discharge from time of concentration
- Compute Q_{wq} from unit peak discharge, drainage area, and WQ_v .

Step 5 Size flow diversion structure, if needed

A flow regulator (or flow splitter diversion structure) should be supplied to divert the WQ_v to the bioretention area.

Size low flow orifice, weir, or other device to pass Q_{wq} .

Step 6 Determine size of bioretention ponding/filter area

The required planting soil filter bed area is computed using the following equation (based on Darcy's Law):

$$A_f = (WQ_v) (d_f) / [(k) (h_f + d_f) (t_f)] \quad (2.1)$$

where:

$$A_f = \text{surface area of ponding area (ft}^2\text{)}$$

- WQ_v = water quality protection volume (or total volume to be captured)
 d_f = filter bed depth (2.5 feet minimum)
 k = coefficient of permeability of filter media (ft/day) (use 0.5 ft/day for silt-loam)
 h_f = average height of water above filter bed (ft) (typically 3 inches, which is half of the 6-inch ponding depth)
 t_f = design filter bed drain time (days) (2.0 days or 48 hours is recommended maximum)

Step 7 Set design elevations and dimensions of facility

See [Section 2.5.3](#) (Physical Specifications/Geometry).

Step 8 Design conveyances to facility (off-line systems)

See the example figures to determine the type of conveyances needed for the site.

Step 9 Design pretreatment

Pretreat with a grass filter strip (on-line configuration) or grass channel (off-line), and stone diaphragm.

Step 10 Size underdrain system

See [Section 2.5.3](#) (Physical Specifications/Geometry)

Step 11 Design emergency overflow

An overflow must be provided to bypass and/or convey larger flows to the downstream drainage system or stabilized watercourse. Nonerosive velocities need to be ensured at the outlet point.

Step 12 Prepare Vegetation and Landscaping Plan

A landscaping plan for the bioretention area should be prepared to indicate how it will be established with vegetation.

See [Section 3.6](#) (Landscaping) and [Section 1.5.2 of the Landscape Technical Manual](#) for more details.

See [Section 29.3](#) for a Bioretention Area Design Example

2.7 Inspection and Maintenance Requirements

Activity	Schedule
<ul style="list-style-type: none"> • Pruning and weeding to maintain appearance. • Mulch replacement when erosion is evident. • Remove trash and debris. 	As needed
<ul style="list-style-type: none"> • Inspect inflow points for clogging (off-line systems). Remove any sediment. • Inspect filter strip/grass channel for erosion or gullyng. Re-seed or sod as necessary. • Trees and shrubs should be inspected to evaluate their health and remove any dead or severely diseased vegetation. 	Semi-annually
<ul style="list-style-type: none"> • The planting soils should be tested for pH to establish acidic levels. If the pH is below 5.2, limestone should be applied. If the pH is above 7.0 to 8.0, then iron sulfate plus sulfur can be added to reduce the pH. 	Annually
<ul style="list-style-type: none"> • Replace mulch over the entire area. • Replace pea gravel diaphragm if warranted (or when the voids are obviously filled with sediment and water is no longer infiltrating). 	2 to 3 years

(Source: EPA, 1999)

Additional Maintenance Considerations and Requirements

The surface of the ponding area may become clogged with fine sediment over time. Core aeration or cultivating of unvegetated areas may be required to ensure adequate filtration.



Regular inspection and maintenance is critical to the effective operation of bioretention facilities as designed. Maintenance responsibility for a bioretention area should be vested with a responsible authority by means of a legally binding and enforceable maintenance agreement that is executed as a condition of plan approval.

2.8 Example Schematics

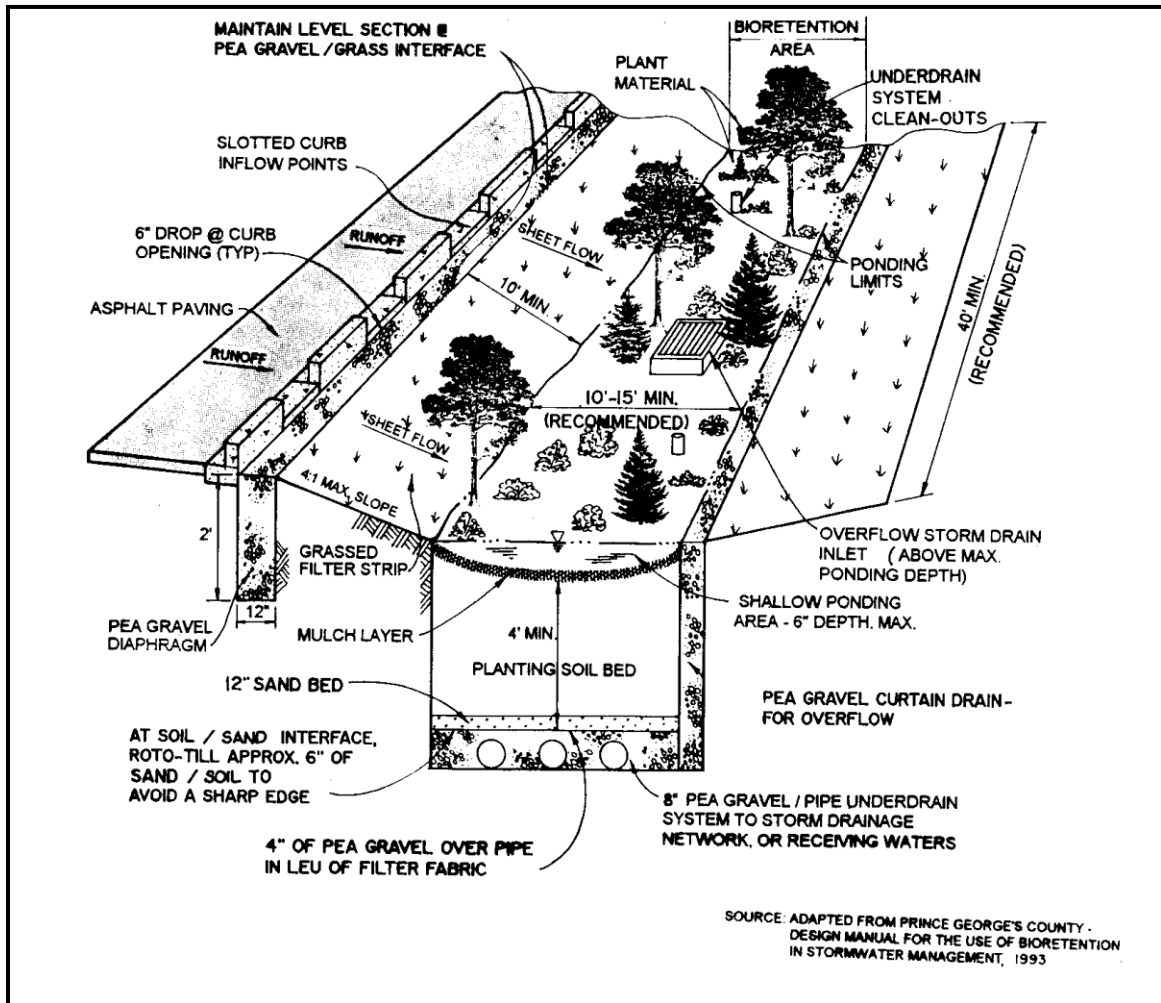

Figure 2.3 Schematic of a Typical Bioretention Area
 (Source: Claytor and Schueler, 1996)

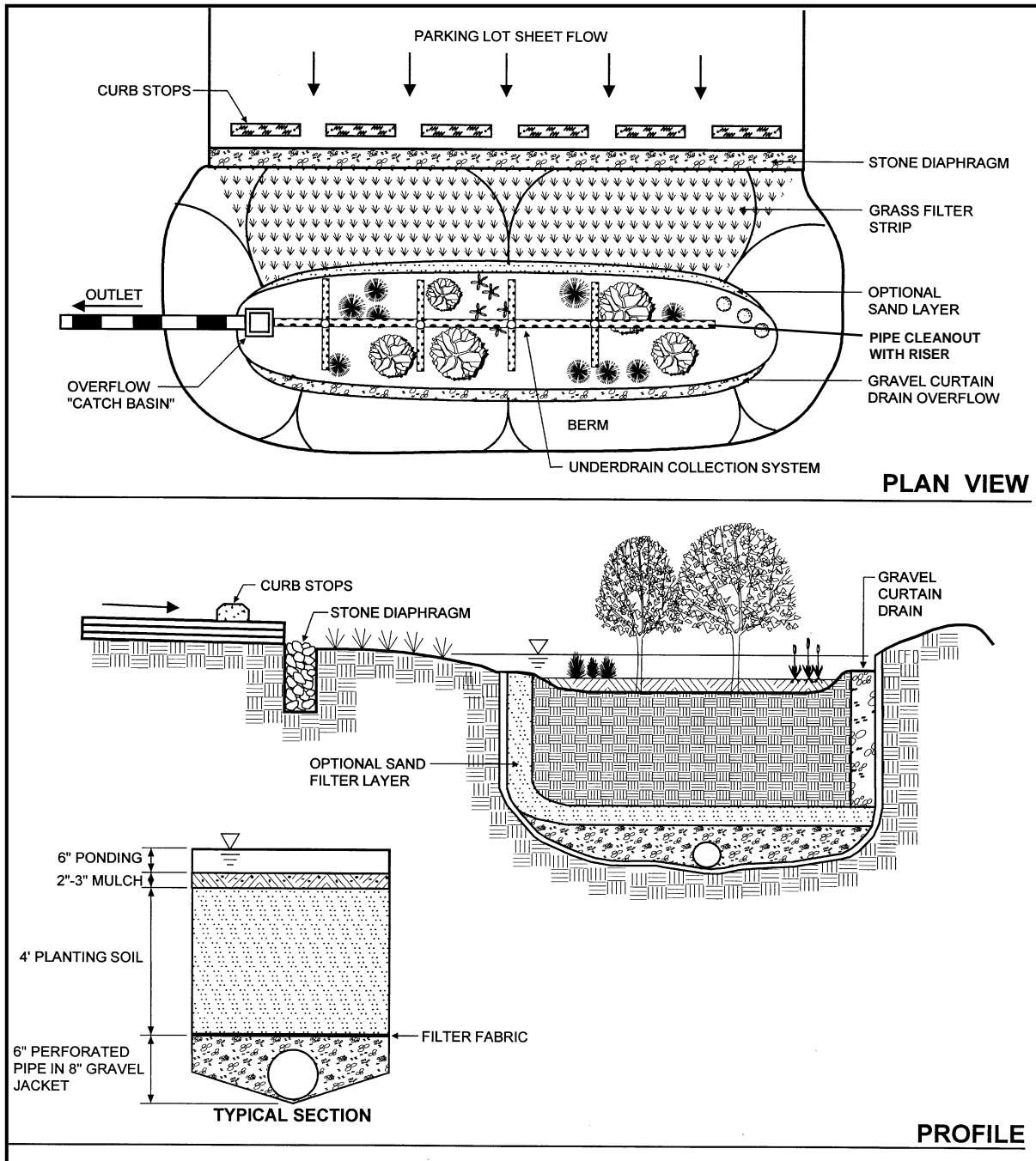

Figure 2.4 Schematic of a Typical On-Line Bioretention Area
(Source: Claytor and Schueler, 1996)

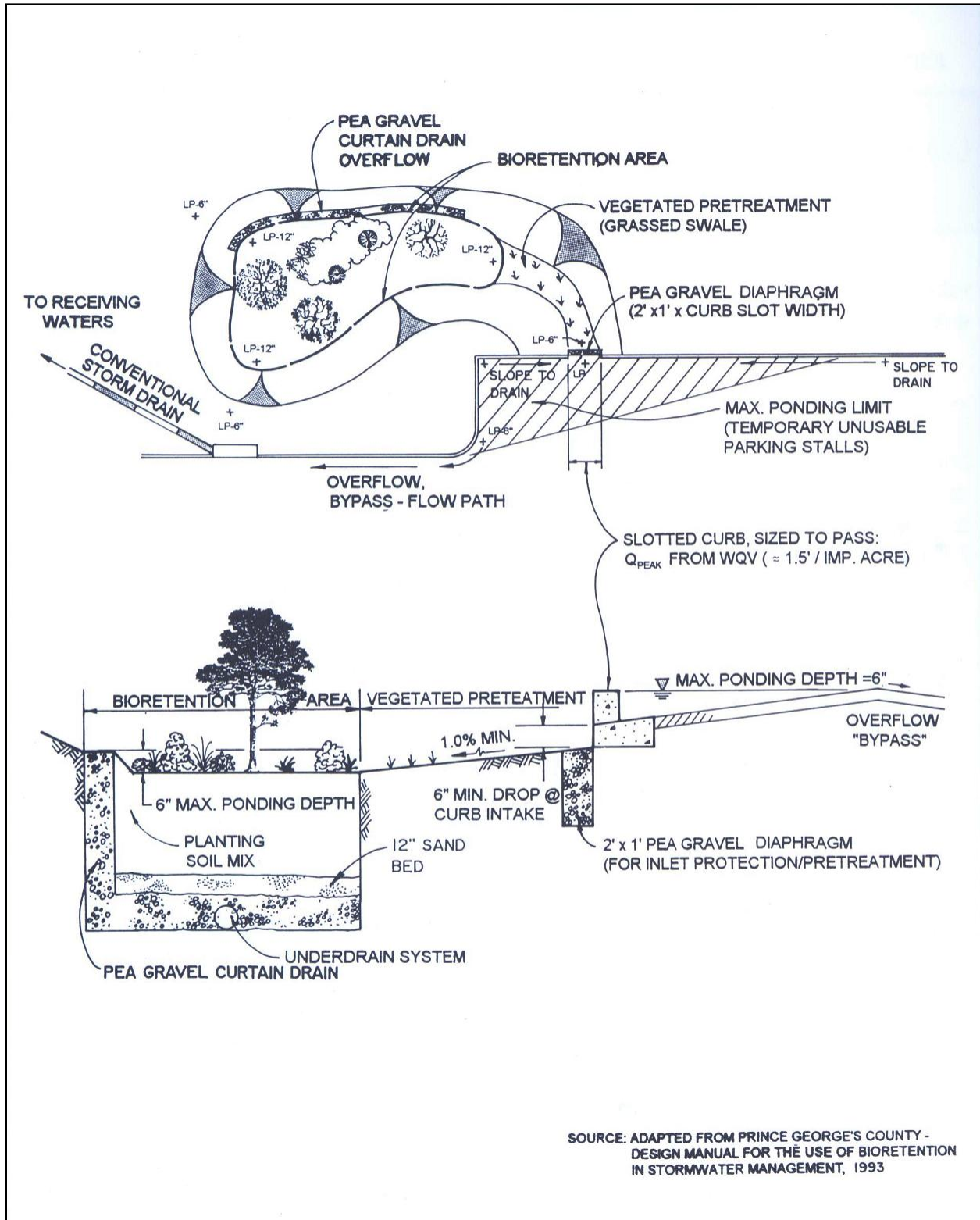

Figure 2.5 Schematic of a Typical Off-Line Bioretention Area
(Source: Clayton and Schueler, 1996)

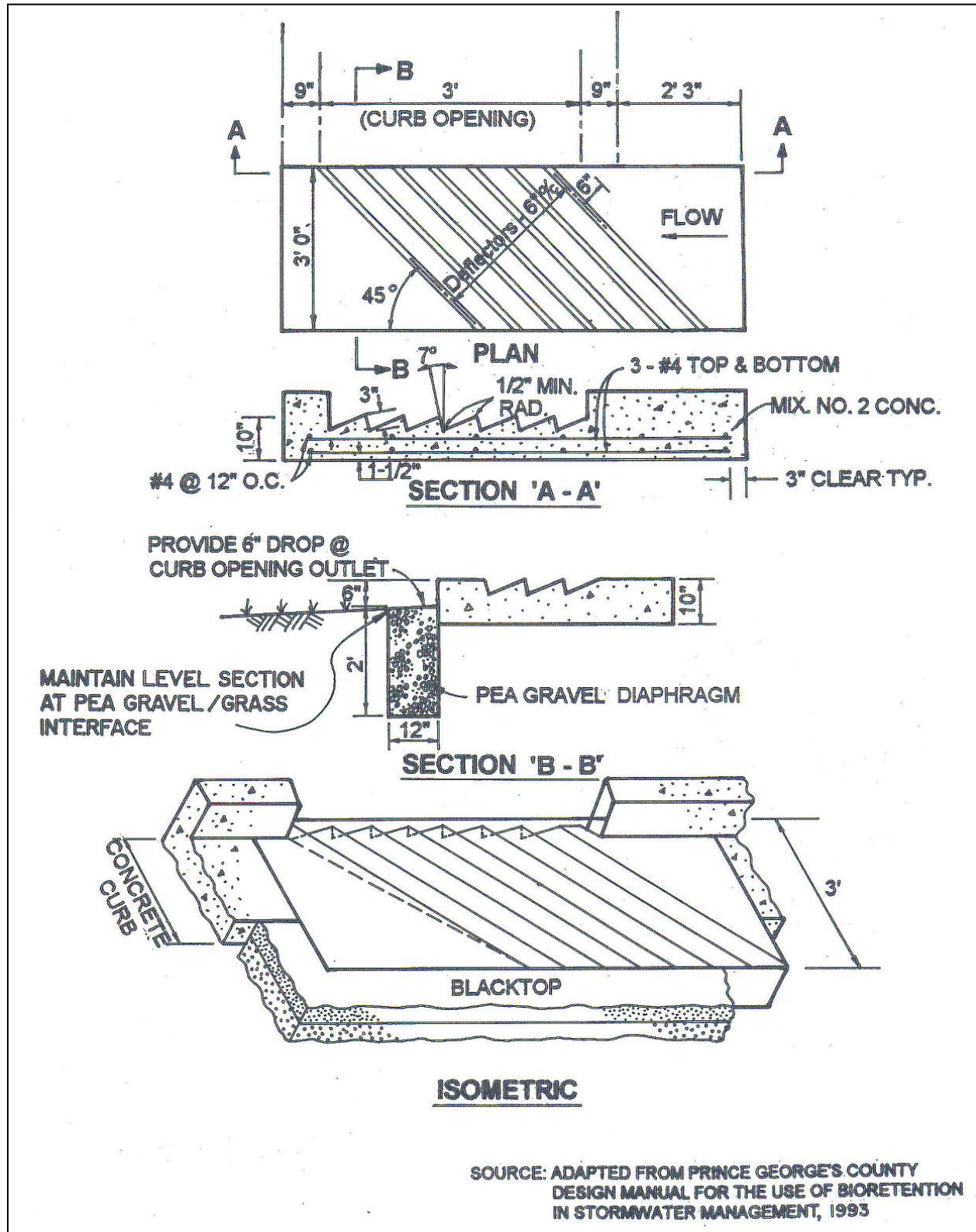

Figure 2.6 Schematic of a Typical Inlet Deflector
 (Source: Claytor and Schueler, 1996)

Table 2.2 Design Procedure Form: Bioretention Areas

Design Procedure Form: Bioretention Areas

<p>PRELIMINARY HYDROLOGIC CALCULATIONS</p> <p>1a. Compute WQ_v volume requirements Compute Runoff Coefficient, R_v Compute WQ_v</p> <p>1b. Compute SP_v Compute average release rate Compute (as necessary) Q_f</p> <p>BIORETENTION AREA DESIGN</p> <p>2. Is the use of a bioretention area appropriate?</p> <p>3. Confirm local design criteria and applicability</p> <p>4. Determine size of bioretention filter area</p> <p>5. Set design elevations and dimensions</p> <p>6. Conveyance to bioretention facility</p> <p>7. Pretreatment</p> <p>8. Size underdrain area Based on guidance: Approx. 10% A_f</p> <p>9. Overdrain design</p> <p>10. Emergency storm weir design Overflow weir - Weir equation</p> <p>11. Choose plants for planting area</p>	<p>$R_v =$ _____</p> <p>$WQ_v =$ _____ acre-ft</p> <p>$SP_v =$ _____ acre-ft</p> <p>release rate = _____ cfs</p> <p>$Q_f =$ _____ cfs</p> <p>See subsections 5.2.1.4 and 5.2.1.5 - A</p> <p>$A_f =$ _____ ft²</p> <p>Length = _____ ft</p> <p>Width = _____ ft</p> <p>_____ elevation top of facility</p> <p>_____ other elev: _____</p> <p>_____ other elev: _____</p> <p>_____ other elev: _____</p> <p>____ Online or ____ Offline?</p> <p>Type: _____</p> <p>Length = _____ ft</p> <p>Type: _____</p> <p>Size: _____</p> <p>Length = _____ ft</p> <p><i>Select native plants based on resistance to drought and inundation, cost, aesthetics, maintenance, etc.</i></p> <p>See Appendix F</p>
--	---

Notes: _____

3.0 Enhanced Swales

General Application
Structural Stormwater Control



Description: Vegetated open channels that are explicitly designed and constructed to capture and treat stormwater runoff within dry or wet cells formed by check dams or other means.

KEY CONSIDERATIONS

DESIGN CRITERIA:

- Longitudinal slopes must be less than 4%
- Bottom width of 2 to 8 feet
- Side slopes 2:1 or flatter; 4:1 recommended
- Convey the “Conveyance” storm event with minimum freeboard, as specified in the Criteria Manual

ADVANTAGES / BENEFITS:

- Combines stormwater treatment with runoff conveyance system
- Less expensive than curb and gutter
- Reduces runoff velocity

DISADVANTAGES / LIMITATIONS:

- Higher maintenance than curb and gutter systems
- Cannot be used on steep slopes
- Possible resuspension of sediment
- Potential for odor / mosquitoes (wet swale)
- Concerns with aesthetics of 4”-6” high grass in residential areas

MAINTENANCE REQUIREMENTS:

- Maintain grass heights of approximately 4 to 6 inches (dry swale)
- Remove sediment from forebay and channel

STORMWATER MANAGEMENT SUITABILITY

- P** Water Quality Protection
- S** Streambank Protection
- S** On-Site Flood Control
- S** Downstream Flood Control

Accepts Hotspot Runoff: Yes
(requires impermeable liner)

IMPLEMENTATION CONSIDERATIONS

- H** Land Requirement
- M** Capital Cost
- L** Maintenance Burden

Residential Subdivision Use: Yes

High Density/Ultra-Urban: No

Drainage Area: 5 acres max.

Soils: No restrictions

Other Considerations:

- Permeable soil layer (dry swale)
- Wetland plants (wet swale)

L=Low M=Moderate H=High

POLLUTANT REMOVAL (DRY SWALE)

80%	Total Suspended Solids
25/40%	Nutrients - Total Phosphorus / Total Nitrogen removal
40%	Metals - Cadmium, Copper, Lead, and Zinc removal
No data	Pathogens - Coliform, Streptococci, E.Coli removal

3.1 General Description

Enhanced swales (also referred to as *vegetated open channels* or *water quality swales*) are conveyance channels engineered to capture and treat the water quality volume (WQ_v) for a drainage area. They differ from a normal drainage channel or swale through the incorporation of specific features that enhance stormwater pollutant removal effectiveness.

Enhanced swales are designed with limited longitudinal slopes to force the flow to be slow and shallow, thus allowing for particulates to settle and limiting the effects of erosion. Berms and/or check dams installed perpendicular to the flow path promote settling and infiltration.

There are two primary enhanced swale designs, the *dry swale* and the *wet swale* (or *wetland channel*). Below are descriptions of these two designs:

- **Dry Swale** – The dry swale is a vegetated conveyance channel designed to include a filter bed of prepared soil that overlays an underdrain system. Dry swales are sized to allow the entire WQ_v to be filtered or infiltrated through the bottom of the swale. Because they are dry most of the time, they are often the preferred option in residential settings.
- **Wet Swale (Wetland Channel)** – The wet swale is a vegetated channel designed to retain water or marshy conditions that support wetland vegetation. A high water table or poorly drained soils are necessary to retain water. The wet swale essentially acts as a linear shallow wetland treatment system, where the WQ_v is retained.



Enhanced Dry Swale



Enhanced Dry Swale

Figure 3.1 Enhanced Swale Examples



Dry and wet swales are not to be confused with a *filter strip* or *grass channel*, which are Limited Application structural controls and not considered acceptable for meeting the TSS removal performance goal by themselves. Ordinary *grass channels* are not engineered to provide the same treatment capability as a well-designed dry swale with filter media. *Filter strips* are designed to accommodate overland flow rather than channelized flow and can be used as stormwater credits to help reduce the total water quality treatment volume for a site. Both of these practices may be used for pretreatment or included in a “treatment train” approach where redundant treatment is provided. Please see a further discussion of these limited application structural controls in [Sections 4.0 and 13.0 of the Site Development Controls Technical Manual](#), respectively.

3.2 Stormwater Management Suitability

Enhanced swale systems are designed primarily for stormwater quality and have only a limited ability to provide streambank protection or to convey higher flows to other controls.

Water Quality

Dry swale systems rely primarily on filtration through an engineered media to provide removal of stormwater contaminants. Wet swales achieve pollutant removal both from sediment accumulation and biological removal.

Section 3.3 provides pollutant removal efficiencies that can be used for planning and design purposes.

Streambank Protection

Generally, only the WQ_v is treated by a dry or wet swale, and another structural control must be used to provide SP_v extended detention. However, for some smaller sites, a swale may be designed to capture and detain the full SP_v .

On-Site Flood Control

Enhanced swales must provide flow diversion and/or be designed to safely pass overbank flood flows. Another structural control must be used in conjunction with an enhanced swale system to reduce the post-development peak flow.

Downstream Flood Control

Enhanced swales must provide flow diversion and/or be designed to safely pass extreme storm flows. Another structural control must be used in conjunction with an enhanced swale system to reduce the post-development peak flow.

3.3 Pollutant Removal Capabilities

Both the dry and wet enhanced swale are presumed to be able to remove 80% of the total suspended solids load in typical urban post-development runoff when sized, designed, constructed, and maintained in accordance with the recommended specifications. Undersized or poorly designed swales can reduce TSS removal performance.

The following design pollutant removal rates are conservative average pollutant reduction percentages for design purposes derived from sampling data, modeling, and professional judgment. In a situation where a removal rate is not deemed sufficient, additional controls may be put in place at the given site in a series or “treatment train” approach.

- Total Suspended Solids – 80%
- Total Phosphorus – Dry Swale 50% / Wet Swale 25%
- Total Nitrogen – Dry Swale 50% / Wet Swale 40%
- Fecal Coliform – insufficient data
- Heavy Metals – Dry Swale 40% / Wet Swale 20%

For additional information and data on pollutant removal capabilities for enhanced dry and wet swales, see the National Pollutant Removal Performance Database (2nd Edition) available at www.cwp.org and the National Stormwater Best Management Practices (BMP) Database at www.bmpdatabase.org

3.4 Application and Feasibility Criteria

Enhanced swales can be used in a variety of development types; however, they are primarily applicable to residential and institutional areas of low to moderate density where the impervious cover in the contributing drainage area is relatively small and along roads and highways. Dry swales are mainly used in moderate to large lot residential developments, small impervious areas (parking lots and rooftops), and

along rural highways. Wet swales tend to be used for highway runoff applications, small parking areas, and in commercial developments as part of a landscaped area.

Because of their relatively large land requirement, enhanced swales are generally not used in higher density areas. In addition, wet swales may not be desirable for some residential applications, due to the presence of standing and stagnant water, which may create nuisance odor or mosquito problems.

The topography and soils of a site will determine the applicability of the use of one of the two enhanced swale designs. Overall, the topography should allow for the design of a swale with sufficient slope and cross-sectional area to maintain nonerosive velocities. The following criteria should be evaluated to ensure the suitability of a stormwater pond for meeting stormwater management objectives on a site or development.

General Feasibility

- Suitable for Residential Subdivision Usage – YES
- Suitable for High Density/Ultra Urban Areas – NO
- Regional Stormwater Control – NO

Physical Feasibility - Physical Constraints at Project Site

- Drainage Area – 5 acres maximum
- Space Required – Approximately 10 to 20% of the tributary impervious area
- Site Slope – Typically no more than 4% channel slope
- Minimum Head – Elevation difference needed at a site from the inflow to the outflow: 3 to 5 feet for dry swale; 1 foot for wet swale
- Minimum Depth to Water Table – 2 feet required between the bottom of a dry swale and the elevation of the seasonally high water table if treating a hotspot or an aquifer recharge zone. Wet swale is below water table or placed in poorly drained soils
- Soils – Engineered media for dry swale

Other Constraints / Considerations

- Aquifer Protection – Infiltration should not be allowed for hotspots

3.5 Planning and Design Criteria

*The following criteria are to be considered **minimum** standards for the design of an enhanced swale system. Consult with the local review authority to determine if there are any variations to these criteria or additional standards that must be followed.*

A Location and Siting

A dry or wet swale should be sited such that the topography allows for the design of a channel with sufficiently mild slope (unless small drop structures are used) and cross-sectional area to maintain nonerosive velocities.

Enhanced swale systems should have a contributing drainage area of 5 acres or less.

Swale siting should also take into account the location and use of other site features, such as buffers and undisturbed natural areas, and should attempt to aesthetically “fit” the facility into the landscape.

A wet swale can be used where the water table is at or near the soil surface, or where there is a sufficient water balance in poorly drained soils to support a wetland plant community.

B General Design

Both types of enhanced swales are designed to treat the WQ_v through a volume-based design, and to safely pass larger storm flows. Flow enters the channel through a pretreatment forebay. Runoff can also enter along the sides of the channel as sheet flow through the use of a pea gravel flow spreader trench along the top of the bank.

Dry Swale

A dry swale system consists of an open conveyance channel with a filter bed of permeable soils that overlays an underdrain system. Flow passes into and is detained in the main portion of the channel where it is filtered through the soil bed. Runoff is collected and conveyed by a perforated pipe and gravel underdrain system to the outlet. Figure 3.2 provides a plan view and cross-section schematic for the design of a dry swale system.

Wet Swale

A wet swale or wetland channel consists of an open conveyance channel which has been excavated to the water table or to poorly drained soils. Check dams are used to create multiple wetland “cells,” which act as miniature shallow marshes. Figure 3.3 provides a plan view and cross-section schematic for the design of a wet swale system.

C Physical Specifications / Geometry

Channel slopes between 1% and 2% are recommended unless topography necessitates a steeper slope, in which case 6- to 12-inch drop structures can be placed to limit the energy slope to within the recommended 1 to 2% range. Energy dissipation will be required below the drops. Spacing between the drops should not be closer than 50 feet. Depth of the WQ_v at the downstream end should not exceed 18 inches.

Dry and wet swales should have a bottom width of 2 to 8 feet to ensure adequate filtration. Wider channels can be designed, but should contain berms, walls, or a multi-level cross section to prevent channel braiding or uncontrolled sub-channel formation.

Dry and wet swales are parabolic or trapezoidal in cross section and are typically designed with moderate side slopes no greater than 2:1 for ease of maintenance and side inflow by sheet flow (4:1 or flatter recommended).

Dry and wet swales should maintain a maximum WQ_v ponding depth of 18 inches at the end point of the channel. A 12-inch average depth should be maintained.

The peak velocity for the 3 storm events (“Streambank Protection”, “Conveyance”, and flood mitigation storm) must be nonerosive for the soil and vegetative cover provided.

If the system is on-line, channels should be sized to convey runoff from a flood event safely with a minimum freeboard and without damage to adjacent property.

Dry Swale

- Dry swale channels are sized to store and infiltrate the entire water quality volume (WQ_v) with less than 18 inches of ponding and allow for full filtering through the permeable soil layer. The maximum ponding time is 48 hours, though a 24-hour ponding time is more desirable.
- The bed of the dry swale consists of a permeable soil layer of at least 30 inches in depth, above a 4-inch diameter perforated PVC pipe (AASHTO M 252) longitudinal underdrain in a 6-inch gravel layer. The soil media should have an infiltration rate of at least 1 foot per day (1.5 feet per day maximum) and contain a high level of organic material to facilitate pollutant removal. A permeable filter fabric is placed between the gravel layer and the overlying soil.

- The channel and underdrain excavation should be limited to the width and depth specified in the design. The bottom of the excavated trench shall not be loaded in a way that causes soil compaction and scarified prior to placement of gravel and permeable soil. The sides of the channel shall be trimmed of all large roots. The sidewalls shall be uniform with no voids and scarified prior to backfilling.

Wet Swale

- Wet swale channels are sized to retain the entire water quality volume (WQ_v) with less than 18 inches of ponding at the maximum depth point.
- Check dams can be used to achieve multiple wetland cells. V-notch weirs in the check dams can be utilized to direct low flow volumes.

D Pretreatment/Inlets

Inlets to enhanced swales must be provided with energy dissipaters such as riprap.

Pretreatment of runoff in both a dry and wet swale system is typically provided by a sediment forebay located at the inlet. The pretreatment volume should be equal to 0.1 inches per impervious acre. This storage is usually obtained by providing check dams at pipe inlets and/or driveway crossings.

Enhanced swale systems that receive direct concentrated runoff may have a 6-inch drop to a pea gravel diaphragm flow spreader at the upstream end of the control.

A pea gravel diaphragm and gentle side slopes should be provided along the top of channels to provide pretreatment for lateral sheet flows.

E Outlet Structures

Dry Swale

- The underdrain system should discharge to the storm drainage infrastructure or a stable outfall.

Wet Swale

- Outlet protection must be used at any discharge point from a wet swale to prevent scour and downstream erosion.

F Emergency Spillway

Enhanced swales must be adequately designed to safely pass flows that exceed the design storm flows.

G Maintenance Access

Adequate access should be provided for all dry and wet swale systems for inspection and maintenance.

H Safety Features

Ponding depths should be limited to a maximum of 18 inches.

I Landscaping

Landscape design should specify proper grass species and wetland plants based on specific site, soils, and hydric conditions present along the channel. Below is some specific guidance for dry and wet swales:

Dry Swale

- Information on appropriate turf grass species for North Central Texas can be found in [Section 1.0 of the Landscape Technical Manual](#).

Wet Swale

- Emergent vegetation should be planted, or wetland soils may be spread on the swale bottom for seed stock.
- Information on establishing wetland vegetation and appropriate wetland species for North Central Texas can be found in the [Landscape Technical Manual](#)
- Where wet swales do not intercept the groundwater table, a water balance calculation should be performed to ensure an adequate water budget to support the specified wetland species. See [Section 4.0 of the Hydrology Technical Manual](#) for guidance on water balance calculations.

J Additional Site-Specific Design Criteria and Issues

Physiographic Factors - Local terrain design constraints

- Low Relief – Reduced need for use of check dams
- High Relief – Often infeasible if slopes are greater than 4%
- Karst – No infiltration of hotspot runoff from dry swales; use impermeable liner

Soils

No additional criteria

Special Downstream Watershed Considerations

- Aquifer Protection – No infiltration of hotspot runoff from dry swales; use impermeable liner

3.6 Design Procedures

Step 1 Compute runoff control volumes from the *integrated* Design Focus Areas

Calculate the Water Quality Volume (WQ_v), Streambank Protection Volume (SP_v), On-Site Flood Control Volume (V_s), and the Downstream Flood Control Volume (V_i).

Details on the *integrated* Design Focus Areas are found in [Section 1.0 of the Planning Technical Manual](#).

Step 2 Determine if the development site and conditions are appropriate for the use of an enhanced swale system (dry or wet swale).

Consider the Application and Site Feasibility Criteria in [Sections 3.4 and 3.5](#) (Location and Siting).

Step 3 Confirm local design criteria and applicability

Consider any special site-specific design conditions/criteria from [Section 3.5](#) (J) (Additional Site-Specific Design Criteria and Issues).

Check with local officials and other agencies to determine if there are any additional restrictions and/or surface water or watershed requirements that may apply.

Step 4 Determine pretreatment volume

The forebay should be sized to contain 0.1 inches per impervious acre of contributing drainage. The forebay storage volume counts toward the total WQ_v requirement, and should be subtracted from the WQ_v for subsequent calculations.

Step 5 Determine swale dimensions

Size bottom width, depth, length, and slope necessary to store WQ_v with less than 18 inches of ponding at the downstream end.

- Slope cannot exceed 4% (1 to 2% recommended)
- Bottom width should range from 2 to 8 feet
- Ensure that side slopes are no greater than 2:1 (4:1 recommended)

See [Section 3.5 \(C\)](#) (Physical Specifications / Geometry) for more details

Step 6 Compute number of check dams (or similar structures) required to detain WQ_v

Step 7 Calculate draw-down time

Dry swale: Planting soil should pass a maximum rate of 1.5 feet in 24 hours and must completely filter WQ_v within 48 hours.

Wet swale: Must hold the WQ_v .

Step 8 Check low flow and design event velocity erosion potential and freeboard

Check for erosive velocities and modify design as appropriate. Provide 6 inches of freeboard.

Step 9 Design low flow orifice at downstream headwalls and checkdams

Design orifice to pass WQ_v in 6 hours. Use Orifice equation.

Step 10 Design inlets, sediment forebay(s), and underdrain system (dry swale)

See [Section 3.5 \(D\)](#) through (H) for more details.

Step 11 Prepare Vegetation and Landscaping Plan

A landscaping plan for a dry or wet swale should be prepared to indicate how the enhanced swale system will be stabilized and established with vegetation.

See [Section 3.5](#) (Landscaping) and the [Landscape Technical Manual](#) for more details.

See [Section 29.6](#) for an Enhanced Swale Design Example

3.7 Inspection and Maintenance Requirements

Table 3.1 Typical Maintenance Activities for Enhanced Swales

(Source: WMI, 1997; Pitt, 1997)

Activity	Schedule
<ul style="list-style-type: none"> For dry swales, mow grass to maintain a height of 4 to 6 inches. Remove grass clippings. 	As needed (frequent/seasonally)
<ul style="list-style-type: none"> Inspect grass along side slopes for erosion and formation of rills or gullies and correct. Remove trash and debris accumulated in the inflow forebay. Inspect and correct erosion problems in the sand/soil bed of dry swales. Based on inspection, plant an alternative grass species if the original grass cover has not been successfully established. Replant wetland species (for wet swale) if not sufficiently established. Inspect pea gravel diaphragm for clogging and correct the problem. 	Annually (Semi-annually the first year)
<ul style="list-style-type: none"> Roto-till or cultivate the surface of the sand/soil bed of dry swales if the swale does not draw down within 48 hours. Remove sediment build-up within the bottom of the swale once it has accumulated to 25% of the original design volume. 	As needed



Regular inspection and maintenance is critical to the effective operation of an enhanced swale system as designed. Maintenance responsibility for a dry or wet swale should be vested with a responsible authority by means of a legally binding and enforceable maintenance agreement that is executed as a condition of plan approval.

3.8 Example Schematics

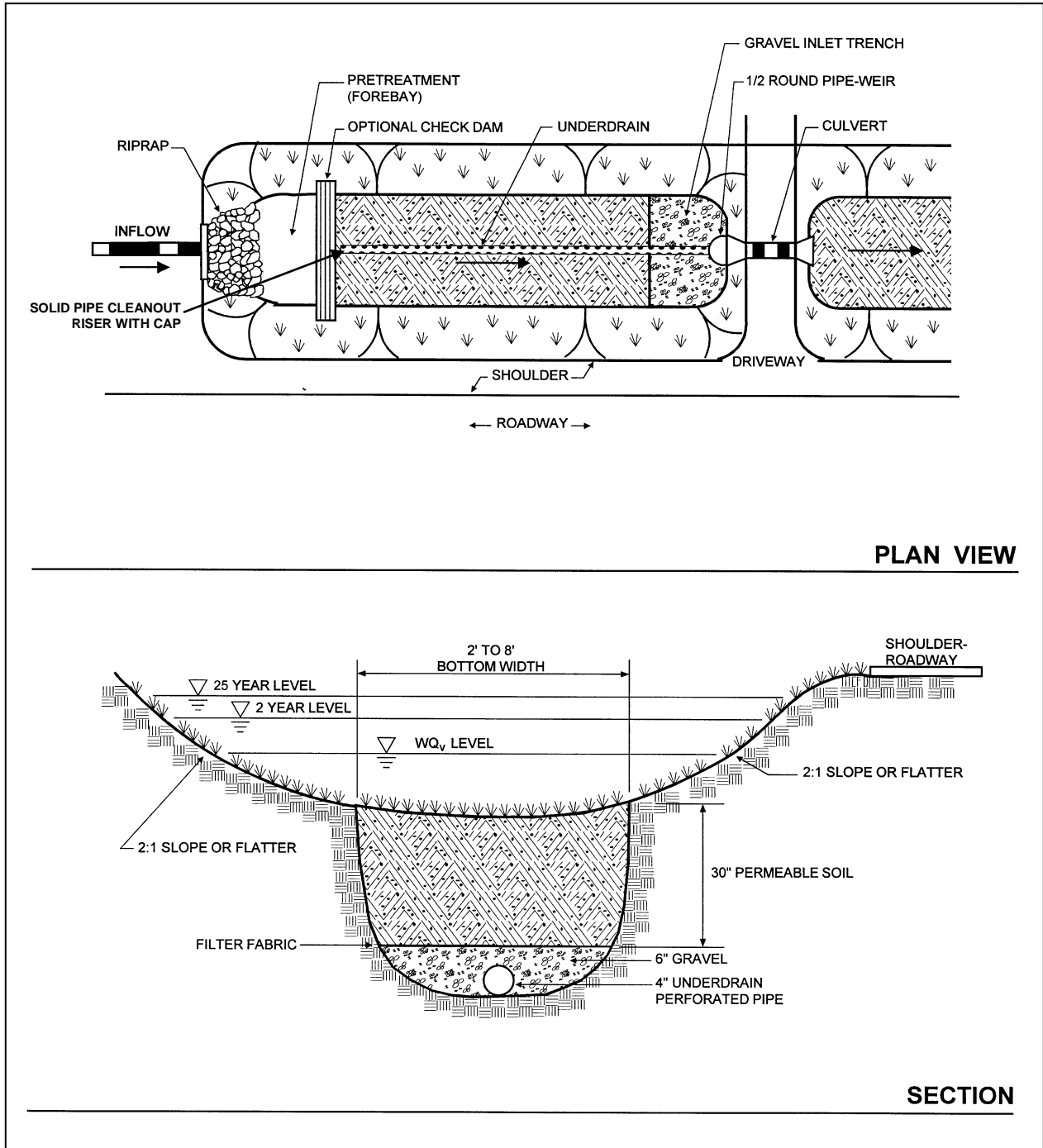

Figure 3.2 Schematic of Dry Swale
 (Source: Center for Watershed Protection)

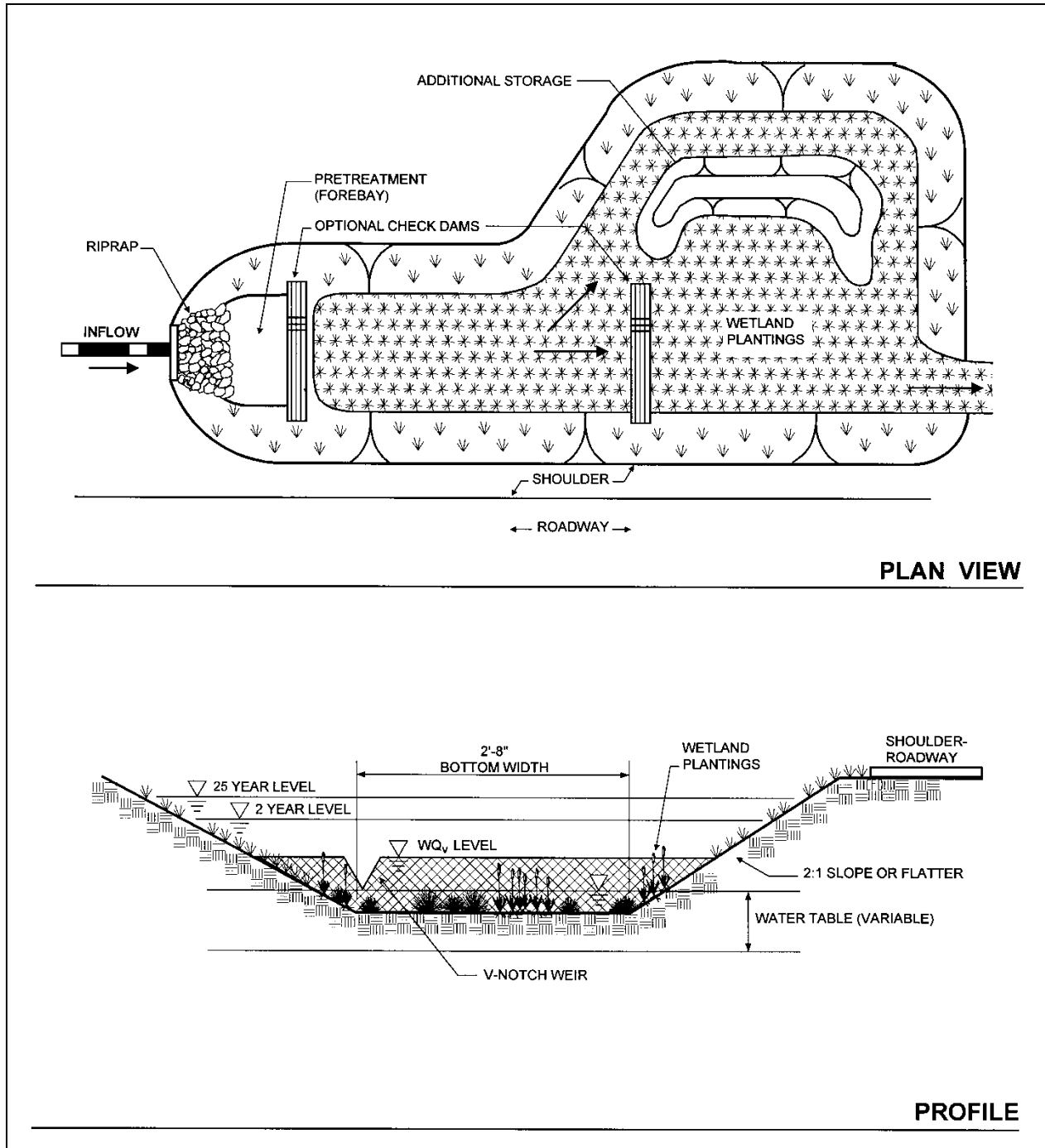

Figure 3.3 Schematic of Wet Swale
 (Source: Center for Watershed Protection)

3.9 Design Forms

Design Procedure Form: Enhanced Swales

PRELIMINARY HYDROLOGIC CALCULATIONS

- 1a. Compute WQ_v volume requirements
 Compute Runoff Coefficient, R_v
 Compute WQ_v
- 1b. Compute SP_v
 Compute average release rate
 Compute Q_p (100-year detention volume required)
 Compute (as necessary) Q_f

$R_v =$ _____
 $WQ_v =$ _____ acre-ft
 $SP_v =$ _____ acre-ft
 release rate = _____ cfs
 $Q_p =$ _____ acre-ft
 $Q_f =$ _____ cfs

ENHANCED SWALE DESIGN

- 2. Is the use of an enhanced swale appropriate?
- 3. Confirm local design criteria and applicability.
- 4. Pretreatment Volume
 $Vol_{pre} = I (0.1") (1'/12")$
- 5. Determine swale dimensions
 Assume trapezoidal channel with max depth of 18 inches

See subsections 5.2.2.4 and 5.2.2.5 - A

See subsection 5.2.2.5 - J

$Vol_{pre} =$ _____ acre-ft

Length = _____ ft
 Width = _____ ft
 Side Slopes = _____
 Area = _____ ft²

- 6. Compute number of check dams (or similar structures) required to detain WQ_v

Slope = _____ ft/ft
 Depth = _____ ft
 Distance = _____ ft
 Number = _____ each

- 7. Calculate draw-down time
 Require $k = 1.5$ ft per day for dry swales

$t =$ _____ hr

- 8. Check low flow and design storm velocity erosion potential and freeboard
 Requires separate computer analysis for velocity

$V_{min} =$ _____ fps

Overflow wier (use weir equation)
 Use weir equation for slot length ($Q = CLH^{3/2}$)

Weir Length = _____ ft

- 9. Design low flow orifice at headwall
 Area of orifice from orifice equation
 $Q = CA(2gh)^{0.5}$

Area = _____ ft²
 diam = _____ inch

- 10. Design inlets, sediment forebays, outlet structures, maintenance access, and safety features.

See subsection 5.2.2.5 - D through H

- 11. Attach landscaping plan (including wetland vegetation)

See Appendix F

Notes: _____

4.0 Grass Channel

Structural Stormwater Control



Description: Vegetated open channels designed to filter stormwater runoff and meet velocity targets for the water quality design storm and the “Streambank Protection” storm event.

KEY CONSIDERATIONS

DESIGN CRITERIA:

- Should not be used on slopes greater than 4%; slopes between 1% and 2% recommended
- Ineffective unless carefully designed to achieve low flow rates in the channel (<1.0 ft/s)

ADVANTAGES / BENEFITS:

- Can be used as part of the runoff conveyance system to provide pretreatment
- Grass channels can act to partially infiltrate runoff from small storm events if underlying soils are pervious
- Less expensive to construct than curb and gutter systems

DISADVANTAGES / LIMITATIONS:

- May require more maintenance than curb and gutter system
- Cannot alone achieve the 80% TSS removal target
- Potential for bottom erosion and re-suspension
- Standing water may not be acceptable in some areas

STORMWATER MANAGEMENT SUITABILITY

- S** Water Quality Protection
- S** Streambank Protection
- P** On-Site Flood Control
- S** Downstream Flood Control

IMPLEMENTATION CONSIDERATIONS

- H** Land Requirement
- L** Capital Cost
- M** Maintenance Burden

Residential Subdivision Use: Yes

High Density/Ultra-Urban: No

Drainage Area: 5 acres max.

Soils: No restrictions

Other Considerations:

- Curb and gutter replacement

L=Low M=Moderate H=High

POLLUTANT REMOVAL

- 50%** Total Suspended Solids
- 25/20%** Nutrients - Total Phosphorus / Total Nitrogen removal
- 30%** Metals - Cadmium, Copper, Lead, and Zinc removal
- No data** Pathogens - Coliform, Streptococci, E.Coli removal

4.1 General Description

Grass channels, also termed “biofilters,” are typically designed to provide nominal treatment of runoff as well as meet runoff velocity targets for the water quality design storm. Grass channels are well suited to a number of applications and land uses, including treating runoff from roads and highways and pervious surfaces.

Grass channels differ from the enhanced dry swale design in that they do not have an engineered filter media to enhance pollutant removal capabilities and, therefore, have a lower pollutant removal rate than for a dry or wet (enhanced) swale. Grass channels can partially infiltrate runoff from small storm events in areas with pervious soils. When properly incorporated into an overall site design, grass channels can reduce impervious cover, accent the natural landscape, and provide aesthetic benefits.

When designing a grass channel, the two primary considerations are channel capacity and minimization of erosion. Runoff velocity should not exceed 1.0 foot per second during the peak discharge associated with the water quality design rainfall event, water depth should generally be less than 4 inches (height of the grass), and the total length of a grass channel should provide at least 5 minutes of residence time. To enhance water quality treatment, grass channels must have broader bottoms, lower slopes, and denser vegetation than most drainage channels. Additional treatment can be provided by placing check-dams across the channel below pipe inflows, and at various other points along the channel.

4.2 Pollutant Removal Capabilities

The following design pollutant removal rates are conservative average pollutant reduction percentages for design purposes derived from sampling data, modeling and professional judgment.

- Total Suspended Solids – 50%
- Total Phosphorus – 25%
- Total Nitrogen – 20%
- Fecal Coliform – insufficient data
- Heavy Metals – 30%

Fecal coliform removal is uncertain. In fact, grass channels are often a source of fecal coliforms from local residents walking their dogs.

4.3 Design Criteria and Specifications

Grass channels should generally be used to treat small drainage areas of less than 5 acres. If the practices are used on larger drainage areas, the flows and volumes through the channel become too large to allow for filtering and infiltration of runoff.

Grass channels should be designed on relatively flat slopes of less than 4%; channel slopes between 1% and 2% are recommended.

Grass channels can be used on most soils with some restrictions on the most impermeable soils. Grass channels should not be used on soils with infiltration rates less than 0.27 inches per hour if infiltration of small runoff flows is intended.

A grass channel should accommodate the peak flow for the water quality design storm Q_{wq} (see [Section 1.0 of the Water Quality Technical Manual](#)).

Grass channels should have a trapezoidal or parabolic cross section with relatively flat side slopes (generally 3:1 or flatter).

The bottom of the channel should be between 2 and 6 feet wide. The minimum width ensures an adequate filtering surface for water quality treatment, and the maximum width prevents braiding, which is the formation of small channels within the swale bottom. The bottom width is a dependent variable in the calculation of velocity based on Manning’s Equation. If a larger channel is needed, the use of a compound cross section is recommended.

Runoff velocities must be nonerosive. The full-channel design velocity will typically govern.

A 5-minute residence time is recommended for the water quality peak flow. Residence time may be increased by reducing the slope of the channel, increasing the wetted perimeter, or planting a denser grass (raising the Manning's n).

The depth from the bottom of the channel to the groundwater should be at least 2 feet to prevent a moist swale bottom, or contamination of the groundwater.

Incorporation of check dams within the channel will maximize retention time.

Designers should choose a grass that can withstand relatively high velocity flows at the entrances for both wet and dry periods. See the *Landscape Technical Manual* for a list of appropriate grasses for use in North Central Texas.

See *Section 3.2 of the Hydraulics Technical Manual* for more information and specifications on the design of grass channels.

Grass Channels for Pretreatment

A number of other structural controls, including bioretention areas and infiltration trenches, may utilize a grass channel as a pretreatment measure. The length of the grass channel depends on the drainage area, land use, and channel slope. Table 4.1 provides sizing guidance for grass channels for a 1-acre drainage area. The minimum grassed channel length should be 20 feet.

Parameter	<= 33% Impervious		Between 34% and 66% Impervious		>= 67% Impervious	
	< 2%	> 2%	< 2%	> 2%	< 2%	> 2%
Slope (max = 4%)	< 2%	> 2%	< 2%	> 2%	< 2%	> 2%
Grass channel minimum length* (feet) <small>*assumes 2-foot wide bottom width</small>	25	40	30	45	35	50

(Source: Claytor and Schueler, 1996)

4.4 Inspection and Maintenance Requirements

Activity	Schedule
<ul style="list-style-type: none"> Mow grass to maintain a height of 3 to 4 inches. 	As needed (frequently/seasonally)
<ul style="list-style-type: none"> Remove sediment build-up within the bottom of the grass channel once it has accumulated to 25% of the original design volume. 	As needed (Infrequently)
<ul style="list-style-type: none"> Inspect grass along side slopes for erosion and formation of rills or gullies and correct. Remove trash and debris accumulated in the channel. Based on inspection, plant an alternative grass species if the original grass cover has not been successfully established. 	Annually (Semi-annually the first year)

(Source: Adapted from CWP, 1996)

4.5 Example Schematics

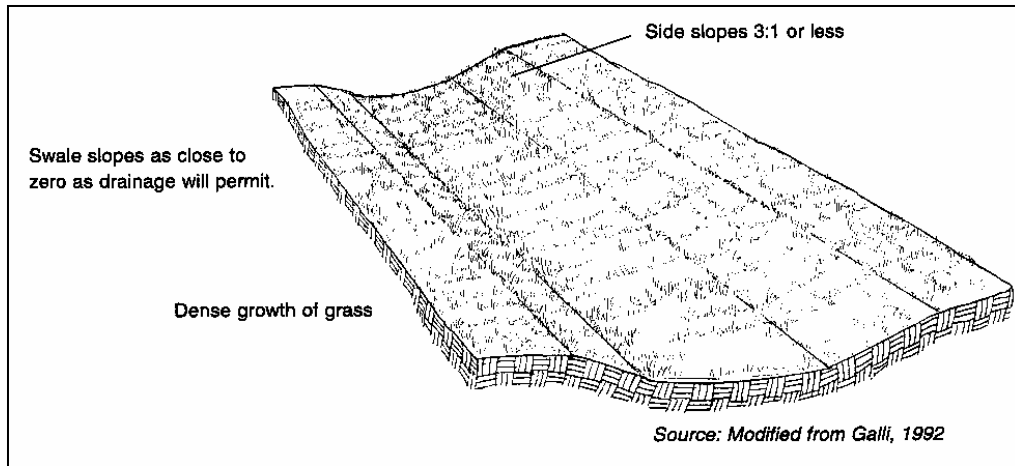

Figure 4.1 Typical Grass Channel

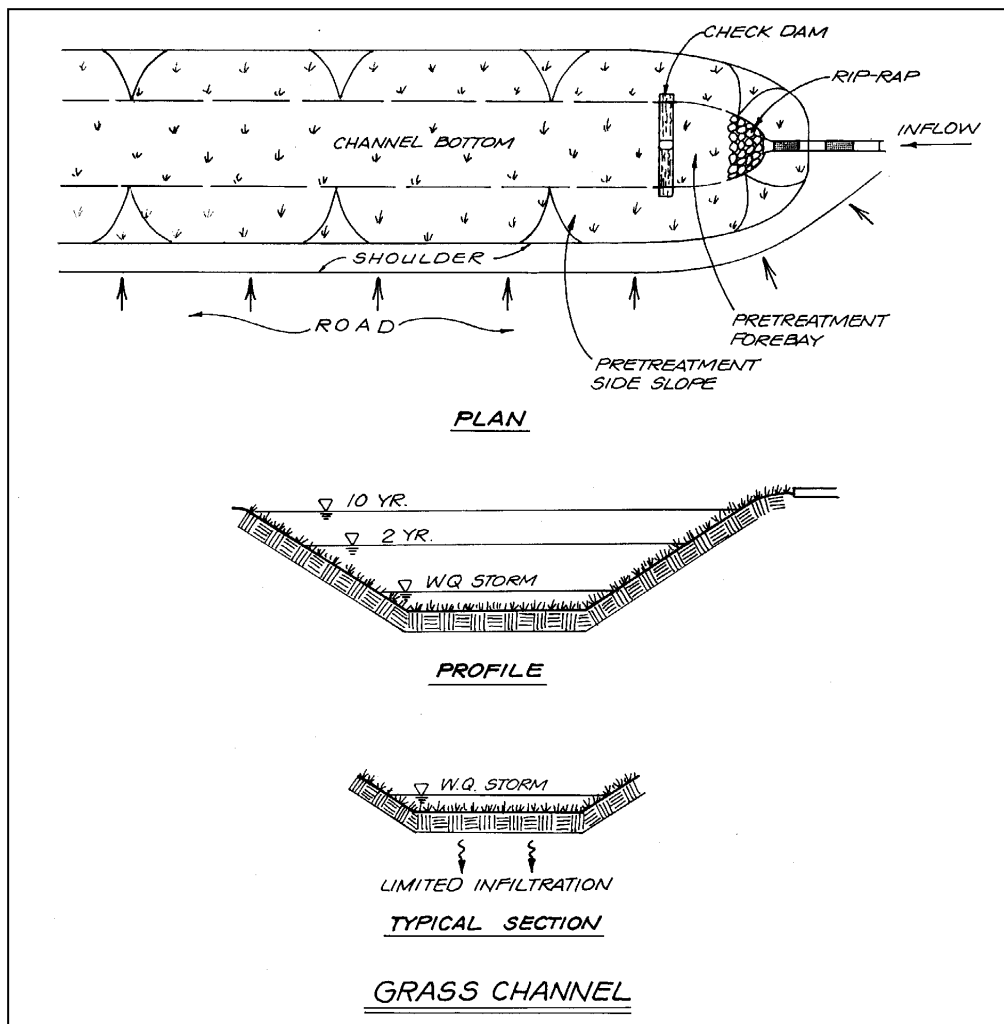

Figure 4.2 Schematic of Grass Channel

4.6 Design Example

Basic Data

Small commercial lot 300 feet deep x 145 feet wide

- Drainage area (A) = 1.0 acres
- Impervious percentage (I) = 70%

Water Quality Peak Flow

See *Section 1.0 of the Water Quality Technical Manual* for details

Compute the Water Quality Protection Volume in inches:

$$WQ_v = 1.5 (0.05 + 0.009 * 70) = 1.02 \text{ inches}$$

Compute modified CN for 1.5-inch rainfall (P=1.5):

$$\begin{aligned} \text{CN} &= 1000/[10+5P+10Q-10(Q^2+1.25*Q*P)^{1/2}] \\ &= 1000/[10+5*1.5+10*0.82-10(0.82^2+1.25*0.82*1.5)^{1/2}] \\ &= 92.4 \quad (\text{Use CN} = 92) \end{aligned}$$

For CN = 92 and an estimated time of concentration (T_c) of 8 minutes (0.13 hours), compute the Q_{wq} for a 1.5-inch storm.

From *Table 1.11 of the Hydrology Technical Manual*, $I_a = 0.174$, therefore $I_a/P = 0.174/1.5 = 0.116$.

From *Figure 1.10 of the Hydrology Technical Manual* for a Type II storm (using the limiting values) $q_u = 950$ csm/in, and therefore:

$$Q_{wq} = (950 \text{ csm/in}) (1.0\text{ac}/640\text{ac}/\text{mi}^2) (1.02") = 1.51 \text{ cfs}$$

Utilize Q_{wq} to Size the Channel

The maximum flow depth for water quality treatment should be approximately the same height of the grass. A maximum flow depth of 4 inches is allowed for water quality design. A maximum flow velocity of 1.0 foot per second for water quality treatment is required. For Manning's n use 0.15 for medium grass, 0.25 for dense grass, and 0.35 for very dense Bermuda-type grass. Site slope is 2%.

Input variables:

$$\begin{aligned} n &= 0.15 \\ S &= 0.02 \text{ ft/ft} \\ D &= 4/12 = 0.33 \text{ ft} \end{aligned}$$

Then:

$$Q_{wq} = Q = VA = 1.49/n D^{2/3} S^{1/2} DW$$

where:

$$\begin{aligned} Q &= \text{peak flow (cfs)} \\ V &= \text{velocity (ft/sec)} \\ A &= \text{flow area (ft}^2\text{)} = WD \\ W &= \text{channel bottom width (ft)} \\ D &= \text{flow depth (ft)} \\ S &= \text{slope (ft/ft)} \end{aligned}$$

(Note: D approximates hydraulic radius for shallow flows)

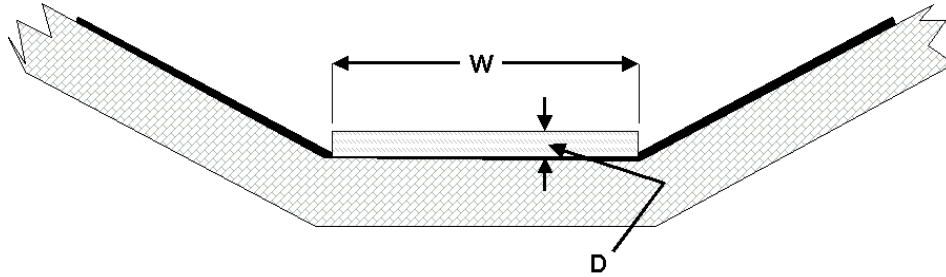

Then for a known n , Q , D and S minimum width can be calculated.

$$(nQ)/(1.49 D^{5/3} S^{1/2}) = W = (0.15 \cdot 1.51)/(1.49 \cdot 0.33^{5/3} \cdot 0.02^{1/2}) = 6.84 \text{ feet minimum}$$

$$V = Q/(WD) = 1.51/(6.84 \cdot 4/12) = 0.66 \text{ fps (okay)}$$

(Note: WD approximates flow area for shallow flows.)

Minimum length for 5-minute residence time, $L = V \cdot (5 \cdot 60) = 198 \text{ feet}$

Depending on the site geometry, the width or slope or density of grass (Manning's n value) might be adjusted to slow the velocity and shorten the channel in the next design iteration. For example, using a 10-foot bottom width* of flow and a Manning's n of 0.20, solve for new depth and length.

$$Q = VA = 1.49/n D^{5/3} S^{1/2} W$$

$$D = [(Q \cdot n)/(1.49 \cdot S^{1/2} \cdot W)]^{3/5}$$

$$= [(1.51 \cdot 0.20)/(1.49 \cdot 0.02^{1/2} \cdot 10.0)]^{3/5} = 0.31 \text{ ft} = 4'' \text{ (okay)}$$

$$V = Q/WD = 1.51/(10.0 \cdot 0.31) = 0.49 \text{ feet per second}$$

$$L = V \cdot 5 \cdot 60 = 146 \text{ feet}$$

* In this case a dividing berm should be used to control potential braiding.

Refer to [Section 3.2 of the Hydraulics Technical Manual](#) to complete the grass channel design for a specified design storm event.

5.0 Open Conveyance Channel

Stormwater Control



Description: An open channel is a conduit in which water flows with a free surface. Open channels include conveyance channels or drainage ditches; grass channels; and enhanced swales. An open conveyance channel is designed for conveyance purposes only.

KEY CONSIDERATIONS

DESIGN CRITERIA:

- A maximum of 2:1 should be used for channel side slopes. Roadside ditches should have maximum side slope of 3:1.
- Slope stability should be confirmed with a geotechnical study or investigation
- Channel banks should be stabilized at site

ADVANTAGES / BENEFITS:

- Can be aesthetically pleasing
- Vegetated channels provide natural habitats
- Once established, little maintenance is required

DISADVANTAGES / LIMITATIONS:

- Velocity will limit the type of channel lining, for example, vegetated channels require slower velocities and lower longitudinal slopes

STORMWATER MANAGEMENT SUITABILITY

- Water Quality Protection
- Streambank Protection
- On-Site Flood Control
- Downstream Flood Control

IMPLEMENTATION CONSIDERATIONS

- Land Requirement
- Capital Cost
- Maintenance Burden

Residential Subdivision Use: Yes
High Density/Ultra-Urban: No
Drainage Area: 5 acres max.
Soils: No restrictions

L=Low M=Moderate H=High

5.1 General Description

An open channel is a conduit in which water flows with a free surface. Open channel systems and their design are an integral part of stormwater drainage design, particularly for development sites utilizing better sited design practices and open channel structural controls. The broad category of open channels includes conveyance channels or drainage ditches, grass channels, and dry and wet enhanced swales. Grass channels and enhanced swales are designed to provide water quality benefits and are further described in detail in *Sections 4.0* and *Section 3.0*, respectively.

Channel Classifications

Open channels may be classified into three main categories according to the type of channel linings: vegetated, flexible, and rigid. Vegetated linings include grass with mulch, sod and lapped sod, and wetland channels. Flexible linings include stone riprap and some forms of flexible man-made linings or gabions. Rigid linings are generally concrete or rigid block.



Figure 5.1 Open Channel Examples

5.2 Pollutant Removal Capabilities

Open conveyance channels or drainage ditches are designed for conveyance purposes only. For open channels with pollutant capabilities, refer to *Section 4.0* and *Section 3.0*, respectively.

5.3 Design Criteria and Specifications

Detailed design criteria and specifications, as prepared by the Federal Highway Administration, are presented in *Section 3.2 of the Hydraulics Technical Manual*. Uniform flow, critical flow, and design details for the three main categories of channel classification (vegetative, riprap, and rigid lining) are also included in the noted section.

In general, the following criteria should be followed for open channel design:

- Channels with bottom widths greater than 10 feet shall be designed with a minimum bottom cross slope of 12 to 1, or with compound cross sections.
- Channel side slopes shall be stable throughout the entire length and side slope shall depend on the channel material. A maximum of 2:1 should be used for channel side slopes, unless otherwise justified by calculations. Roadside ditches should have a maximum side slope of 3:1. All side slopes should be verified with a geotechnical evaluation to ensure slope stability.
- Trapezoidal or parabolic cross sections are preferred over triangular shapes.
- If relocation of a stream channel is unavoidable, the cross-sectional shape, meander, pattern, roughness, sediment transport, and slope should conform to the existing conditions insofar as practicable. Some means of energy dissipation may be necessary when existing conditions cannot be duplicated.

- Streambank stabilization should be provided, when appropriate, as a result of any stream disturbance such as encroachment and should include both upstream and downstream banks as well as the local site.
- Open channel drainage systems are sized to adequately convey the “Conveyance” design storm, and are normally checked with the flood mitigation storm event.

5.4 Inspection and Maintenance Requirements

Open channels should be inspected after large storm events for debris causing blockages or re-routing. Channels with vegetated linings should be inspected and maintained periodically to insure vegetation is still in place and prevent growth of taller or woody vegetation. Flexible linings, such as rock riprap, have self-healing qualities that reduce maintenance. However, they should be inspected and maintained periodically to prevent growth of trees, grass, and weeds. Concrete channels should be checked periodically for scour at the channel lining transitions and channel headcutting.

6.0 Alum Treatment System

Structural Stormwater Control



Description: Chemical treatment of stormwater runoff entering a wet pond by injecting liquid alum into storm sewer lines on a flow-weighted basis during rain events.

KEY CONSIDERATIONS

ADVANTAGES / BENEFITS:

- Requires no additional land purchase
- Reduces concentrations of total phosphorus, total aluminum and heavy metals
- Dependent on pH level ranging from 6.0 to 7.5 during treatment process

DISADVANTAGES / LIMITATIONS:

- Intended for areas requiring regional stormwater treatment from a piped stormwater drainage system
- High maintenance requirements
- Alum application will lower pH of receiving waters
- High capital and operations and maintenance costs

STORMWATER MANAGEMENT SUITABILITY

- P** Water Quality Protection
- Streambank Protection
- On-Site Flood Control
- Downstream Flood Control

IMPLEMENTATION CONSIDERATIONS

- L** Land Requirement
- H** Capital Cost
- H** Maintenance Burden

Residential Subdivision Use: Yes

High Density/Ultra-Urban: Yes

Drainage Area: 25 acres min.

Soils: No restrictions

Other Considerations:

- Regional Treatment

POLLUTANT REMOVAL

90%	Total Suspended Solids
80/60%	Nutrients - Total Phosphorus / Total Nitrogen removal
75%	Metals - Cadmium, Copper, Lead, and Zinc removal
90%	Pathogens - Coliform, Streptococci, E.Coli removal

L=Low M=Moderate H=High

6.1 General Description

The process of alum (aluminum sulfate) treatment provides treatment of stormwater runoff from a piped stormwater drainage system entering a wet pond by injecting liquid alum into storm sewer lines on a flow-weighted basis during rain events. When added to runoff, liquid alum forms nontoxic precipitates of aluminum hydroxide $[\text{Al}(\text{OH})_3]$ and aluminum phosphate $[\text{AlPO}_4]$. However, Alum will lower the pH of receiving waters and must be closely monitored to avoid adverse impacts on aquatic life.

The alum precipitate or “floc” formed during coagulation of stormwater combines with phosphorus, suspended solids, and heavy metals and removes them from the water column. The floc can be allowed to settle in receiving water or collected in small settling basins. Once settled, the floc is stable in sediments and will not re-dissolve due to changes in redox potential or pH under conditions normally found in surface water bodies. Laboratory or field testing may be necessary to verify feasibility and to establish design, maintenance, and operational parameters, such as the optimum coagulant dose required to achieve the desired water quality goals, chemical pumping rates and pump sizes.

Construction costs for existing alum stormwater treatment facilities in Florida have ranged from \$135,000 to \$400,000. The capital construction costs of alum stormwater treatment systems is independent of watershed size and depends primarily on the number of outfall locations treated.

Estimated annual operations and maintenance (O&M) costs for chemicals and routine inspections range from approximately \$6,500 to \$25,000 per year. O&M costs include chemical, power, manpower for routine inspections, equipment renewal, and replacement costs.

Ferric chloride has also been used for flow-proportional injection for removing phosphorus and other pollutants. Although ferric chloride is less toxic to aquatic life than alum, it has a number of significant disadvantages. Ferric chloride dosage rates are dependent on the pollutant concentrations in the stormwater runoff, unlike alum. Ferric chloride does not form a floc that settles out suspended pollutants. And, once settled, ferric chloride may be released from sediments under anoxic conditions.

6.2 Pollutant Removal Capabilities

Alum treatment has consistently achieved a 85 to 95% reduction in total phosphorus, 90 to 95% reduction in orthophosphorus, 60 to 70% reduction in total nitrogen, 50 to 90% reduction in heavy metals, 95 to 99% reduction in turbidity and TSS, 60% reduction in BOD, and >99% reduction in fecal coliform bacteria compared with raw stormwater characteristics.

The following design pollutant removal rates are conservative average pollutant reduction percentages for design purposes derived from sampling data, modeling, and professional judgment.

- Total Suspended Solids – 90%
- Total Phosphorus – 80%
- Total Nitrogen – 60%
- Fecal Coliform – 90%
- Heavy Metals – 75%

6.3 Design Criteria and Specifications

Alum treatment systems are fairly complex, and design details are beyond the scope of this Manual. However, further information can be obtained from the Internet and by contacting local municipalities and engineers who have designed and implemented successful systems. The following are general guidelines for alum treatment systems:

- Injection points should be 100 feet upstream of discharge points.
- Alum concentration is typically 10 $\mu\text{g}/\text{l}$.
- Alum treatment systems may need to control pH.

- For new pond design, the required size is approximately 1% of the drainage basin size, as opposed to 10 to 15% of the drainage basin area for a standard detention pond.
- No additional volume is required when discharging to existing lakes.

6.4 Inspection and Maintenance Requirements

Activity	Schedule
<ul style="list-style-type: none"> • Perform routine inspection. • Monitor water quality and pH of receiving water. 	Monthly
<ul style="list-style-type: none"> • Perform maintenance of pump equipment, chemical supplies, and delivery system. 	As Needed

(Source: Harper, Herr, and Livingston)



Figure 6.1 Alum Treatment System and Injection Equipment

7.0 Culverts

Stormwater Control



Description: A short, closed (covered) conduit that conveys stormwater runoff under an embankment, usually a roadway.

KEY CONSIDERATIONS

DESIGN CRITERIA:

- Designed for conveyance purposes, not pollutant removal capability
- Normally designed for the “Conveyance” storm event

VELOCITY:

- Maximum velocity of 15 fps for corrugated metal pipe
- Minimum velocity of 2.5 fps, for the “Streambank Protection” storm event

SLOPE:

- Maximum slope of 14% for corrugated metal pipe
- Maximum slope of 10% for concrete pipe
- Maximum drop in a drainage structure is 10 feet.

OTHER:

- Skew not to exceed 45 degrees
- Minimum diameter of 18 inches

MAINTENANCE REQUIREMENTS:

- Reinforced concrete pipe for use (1) under roadway, (2) when pipe slopes are less than 1%, or (3) for all flowing streams.
- RCP and fully coated corrugated metal pipe
- High-density polyethylene (HDPE) may be used as specified in municipal regulations

STORMWATER MANAGEMENT SUITABILITY

- Water Quality Protection
- Streambank Protection
- P** On-Site Flood Control
- P** Downstream Flood Control

IMPLEMENTATION CONSIDERATIONS

- Land Requirement
- Capital Cost
- Maintenance Burden

Residential Subdivision Use: Yes

High Density/Ultra-Urban: Yes

Drainage Area: No restrictions.

Soils: No restrictions

L=Low M=Moderate H=High

7.1 General Description

A culvert is a short, closed (covered) conduit that conveys stormwater runoff under an embankment, usually a roadway. The primary purpose of a culvert is to convey surface water, but properly designed it may also be used to restrict flow and reduce downstream peak flows. In addition to the hydraulic function, a culvert must also support the embankment and/or roadway, and protect traffic and adjacent property owners from flood hazards to the extent practicable.

7.2 Pollutant Removal Capabilities

Culverts are designed for stormwater conveyance purposes and do not provide pollutant removal capabilities.

7.3 Design Criteria and Specifications

The design of a culvert should take into account many different engineering and technical aspects at the culvert site and adjacent areas. The following design criteria should be considered for all culvert designs as applicable:

- Frequency Flood;
- Velocity Limitations;
- Buoyancy Protection;
- Length and Slope;
- Debris Control;
- Headwater Limitations;
- Tailwater Considerations;
- Storage;
- Inlets;
- Inlets with Headwalls;
- Wingwalls and Aprons;
- Improved Inlets;
- Material Selection;
- Culvert Skews;
- Culvert Sizes;
- Weep Holes;
- Outlet Protection;
- Erosion and Sediment Control; and
- Environmental Considerations.

There are two types of flow conditions for culverts (see Figure 7.1) that are based upon the location of the control section and the critical flow depth:

- **Inlet Control** – Inlet control occurs when the culvert barrel is capable of conveying more flow than the inlet will accept. This typically happens when a culvert is operating on a steep slope. The control section of a culvert is located just inside the entrance. Critical depth occurs at or near this location, and the flow regime immediately downstream is supercritical.
- **Outlet Control** – Outlet control flow occurs when the culvert barrel is not capable of conveying as much flow as the inlet opening will accept. The control section for outlet control flow in a culvert is located at the barrel exit or further downstream. Either subcritical or pressure flow exists in the culvert barrel under these conditions.

Proper culvert design and analysis requires checking for both inlet and outlet control to determine which will govern particular culvert designs.

There are three procedures for designing culverts: manual use of inlet and outlet control equations, nomographs, and the use of computer programs such as HY8. It is recommended that the HY8 computer model or equivalent be used for culvert design. The computer software package HYDRAIN, which includes HY8, uses the theoretical basis from the nomographs to size culverts. In addition, this software can evaluate improved inlets, route hydrographs, consider road overtopping, and evaluate outlet streambed scour. By using water surface profiles, this procedure is more accurate in predicting backwater effects and outlet scour.

Examples of small culverts are shown in Figure 7.2. See [Section 3.3 of the Hydraulics Technical Manual](#) for detailed culvert design procedures and instruction.

7.4 Inspection and Maintenance Requirements

Culverts located at the end of urban drainage channels are often clogged by refuse dumped into the channel or by trash washed off the city streets. Under such conditions, a debris rack can usually be installed at a low cost to prevent clogging. In designing debris control structures it is recommended that the Federal Highway Administration, Hydraulic Engineering Circular No. 9 entitled *Debris Control Structures* be consulted. This Circular discusses the variety of methods for controlling debris by: (a) intercepting the debris at or above the inlet; (b) deflecting the debris for detention near the inlet; or (c) passing the debris through the structure.

Additionally, to ensure self-cleaning during partial depth flow, a minimum velocity of 2.5 feet per second, for the 2-year flow, when the culvert is flowing partially full is required.

7.5 Example Schematic

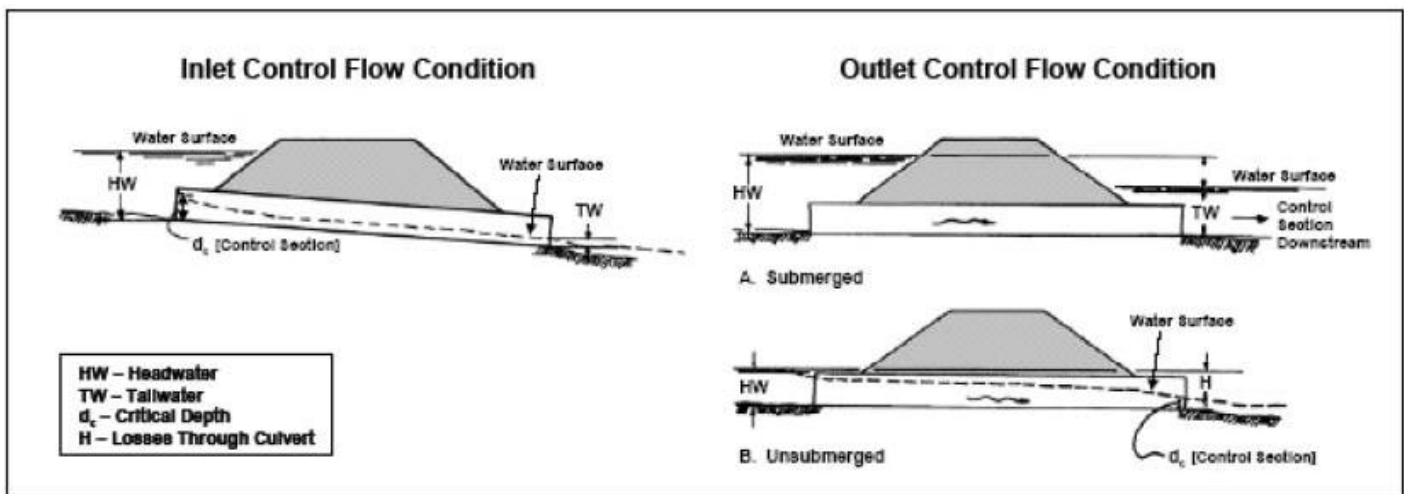

Figure 7.1 Culvert Flow Conditions



Figure 7.2 Culvert Examples

8.0 Inlets

Stormwater Controls



Description: Drainage structure used to collect surface water through grate or curb openings and convey it to pipe systems or direct outlet to culverts.

KEY CONSIDERATIONS

DESIGN CRITERIA:

- Designed for conveyance purposes, not pollutant removal capability
- Interception capacity depends on depth of water next to curb.

ADVANTAGES / BENEFITS:

- Aesthetically pleasing, less obvious than most stormwater structures.

DISADVANTAGES / LIMITATIONS:

- Efficiency is typically reduced in order to meet safety standards.

MAINTENANCE REQUIREMENTS:

- Must be inspected and cleaned regularly due to trash and debris build-up.

STORMWATER MANAGEMENT SUITABILITY

- Water Quality Protection
- Streambank Protection
- On-Site Flood Control
- Downstream Flood Control

IMPLEMENTATION CONSIDERATIONS

- Land Requirement
- Capital Cost
- Maintenance Burden

Residential Subdivision Use:

Yes

High Density/Ultra-Urban: Yes

Drainage Area: No restrictions.

Soils: No restrictions

Other Considerations: Overflow parking, driveways and related issues

L=Low M=Moderate H=High

8.1 General Description

Inlets are drainage structures used to collect surface water through grate or curb openings and convey it to pipe systems or direct outlet to culverts. Inlets are typically located in close proximity to impervious areas such as streets and parking lots. Inlets can also be located at a low point in a channel or area that concentrates overland flow (ponding areas).

8.2 Pollutant Removal Capabilities

Although inlets prevent large debris from passing to the storm sewer system, they are designed for stormwater conveyance purposes and do not provide pollutant removal capabilities.

8.3 Design Criteria and Specifications

Inlets used for drainage of surfaces can be divided into three major classes:

- Grate Inlets – These inlets include grate inlets, consisting of an opening in the gutter covered by one or more grates, and slotted inlets, consisting of a pipe cut along the longitudinal axis with a grate or spacer bars to form slot openings.
- Curb-Opening Inlets – These inlets are vertical openings in the curb covered by a top slab.
- Combination Inlets – These inlets usually consist of both a curb-opening inlet and a grate inlet placed in a side-by-side configuration, but the curb opening may be located in part upstream of the grate.

Inlets may be classified as on a *continuous grade* or in a *sump*. The term “continuous grade” refers to an inlet located on the street with a continuous slope past the inlet with water entering from one direction. The “sump” condition exists when the inlet is located at a low point and water enters from both directions. There are specific design criteria for the following types of inlets:

- Grate Inlets on Grade
- Grate Inlets in Sag
- Curb Inlets on Grade
- Curb Inlets in Sump
- Combination Inlets on Grade
- Combination Inlets in Sump

Where significant ponding can occur, in locations such as underpasses and in sag vertical curves in depressed sections, it is good engineering practice to place flanking inlets on each side of the inlet at the low point in the sag. The flanking inlets should be placed so that they will limit spread on low gradient approaches to the level point and act in relief of the inlet at the low point if it should become clogged or if the design spread is exceeded.

When designing an inlet, the grate length, bar configuration, and gutter velocity must be taken into account. Inlet location should not compromise safety or aesthetics. It should not allow for standing water in areas of vehicular or pedestrian traffic, and should take advantage of natural depression storage where possible. Grate inlets subject to traffic should be bicycle safe (horizontal and vertical cross-bars) and provide adequate load-bearing capabilities.

See [Section 3.3 of the Hydraulics Technical Manual](#) for detailed inlet design procedures and instruction.

8.4 Inspection and Maintenance Requirements

Inlets are often blocked by trash washed off the city streets and parking lots. Regular inspection and removal of this debris will result in cleaner, more efficient stormwater conveyance systems. The public might also misunderstand inlets as places to dispose of household wastes. To prevent this and to promote water quality education, some municipalities and non-profit organizations have begun “stamping” inlets or attaching decals with “No Dumping” instructions.



Grate Inlet in Parking Lot



Slotted Inlet



Curb Inlet



Stamp on Inlet



Combination Inlet

Figure 8.1 Example Inlets

9.0 Pipe Systems

Stormwater Control



Description: Pipe conveyances used for transporting runoff from roadway and other inlets to outfalls at structural stormwater controls and receiving waters.

KEY CONSIDERATIONS

DESIGN CRITERIA:

- Designed for conveyance purposes, not pollutant removal capability
- All systems should be designed with velocities greater than 2.5 fps with a minimum slope of 0.5%
- Size system under the assumption of full flow, but not pressure flow
- Hydraulic gradient should not produce velocity in excess of 15 fps
- Manning’s Equation recommended for capacity computations

STORMWATER MANAGEMENT SUITABILITY

- Water Quality Protection
- Streambank Protection
- On-Site Flood Control
- Downstream Flood Control

IMPLEMENTATION CONSIDERATIONS

- Land Requirement
- Capital Cost
- Maintenance Burden

Residential Subdivision Use: Yes

High Density/Ultra-Urban: Yes

Drainage Area: No restrictions.

Soils: No restrictions

L=Low M=Moderate H=High

9.1 General Description

Storm drain pipe systems, also known as *storm sewers*, are pipe conveyances used in the minor stormwater drainage system for transporting runoff from roadway and other inlets to outfalls at structural stormwater controls and receiving waters. Pipe drain systems are suitable mainly for medium to high-density residential and commercial/industrial development where the use of natural drainageways and/or vegetated open channels is not feasible.

9.2 Pollutant Removal Capabilities

The stormwater pipe system is designed for conveyance purposes and does not provide pollutant removal capabilities.

9.3 Design Criteria and Specifications

The design of storm drain systems generally follows these steps:

- Step 1 Determine inlet location and spacing.
- Step 2 Prepare a tentative plan layout of the storm sewer drainage system including:
 - a. Location of storm drains
 - b. Direction of flow
 - c. Location of manholes
 - d. Location of existing facilities such as water, gas, or underground cables
- Step 3 Determine drainage areas and compute runoff using the Rational Method
- Step 4 After the tentative locations of inlets, drain pipes, and outfalls (including tailwaters) have been determined and the inlets sized, compute the rate of discharge to be carried by each storm drain pipe and determine the size and gradient of pipe required to care for this discharge. This is done by proceeding in steps from upstream of a line to downstream to the point at which the line connects with other lines or the outfall, whichever is applicable. The discharge for a run is calculated, the pipe serving that discharge is sized, and the process is repeated for the next run downstream. The storm drain system design computation form ([Figure 1.27 of the Hydraulics Technical Manual](#)) can be used to summarize hydrologic, hydraulic, and design computations.
- Step 5 Examine assumptions to determine if any adjustments are needed to the final design.

It should be recognized that the rate of discharge to be carried by any particular section of storm drain pipe is not necessarily the sum of the inlet design discharge rates of all inlets above that section of pipe, but as a general rule is somewhat less than this total. It is useful to understand that the time of concentration is most influential and as the time of concentration grows larger, the proper rainfall intensity to be used in the design grows smaller.

See [Section 1.2 of the Hydraulics Technical Manual](#) for detailed pipe system design procedures and instruction.

9.4 Inspection and Maintenance Requirements

Maintaining stormwater conveyance structures on a regular basis will prevent clogging of the downstream conveyance system and ensure the system functions properly hydraulically to avoid flooding.

Storm Drain Conveyance System

- Locate reaches of storm drain with deposit problems and develop a flushing schedule that keeps the pipe clear of excessive buildup.
- Collect flushed effluent and pump to the sanitary sewer for treatment after sediment removal, if necessary.

Illicit Connections and Discharges

- During routine maintenance of conveyance system and drainage structures field staff should look for evidence of illegal discharges or illicit connections:
 - Is there evidence of spills such as paints, discoloring, etc.
 - Are there any odors associated with the drainage system
 - Record locations of apparent illegal discharges/illicit connections
 - Track flows back to potential dischargers and conduct aboveground inspections. This can be done through visual inspection of up gradient manholes or alternate techniques including zinc chloride smoke testing, fluorometric dye testing, physical inspection testing, or television camera inspection.
 - Once the origin of flow is established, require illicit discharger to eliminate the discharge.
- Stencil storm drains, where applicable, to prevent illegal disposal of pollutants. Storm drain inlets should have messages such as “Dump No Waste Drains to Stream” stenciled next to them to warn against uninformed or intentional dumping of pollutants into the storm drainage system.

Illegal Dumping

- Regularly inspect and clean up hot spots and other storm drainage areas where illegal dumping and disposal occurs.
- Establish a system for tracking incidents. The system should be designed to identify the following:
 - Illegal dumping hot spots
 - Types and quantities (in some cases) of wastes
 - Patterns in time of occurrence (time of day/night, month, or year)
 - Mode of dumping (abandoned containers, “midnight dumping” from moving vehicles, direct dumping of materials, accidents/spills)
 - Responsible parties
- Post “No Dumping” signs in problem areas with a phone number for reporting dumping and disposal. Signs should also indicate fines and penalties for illegal dumping.

Storm drain flushing is most effective in small diameter pipes (36-inch diameter pipe or less, depending on water supply and sediment collection capacity). Other considerations associated with storm drain flushing may include the availability of a water source, finding a downstream area to collect sediments, liquid/sediment disposal, and disposal of flushed effluent to sanitary sewer may be prohibited in some areas.

Maintenance

- Identifying illicit discharges requires teams of at least two people (volunteers can be used), plus administrative personnel, depending on the complexity of the storm sewer system.
- Arrangements must be made for proper disposal of collected wastes.
- Requires technical staff to detect and investigate illegal dumping violations, and to coordinate public education.

9.5 Example Schematic

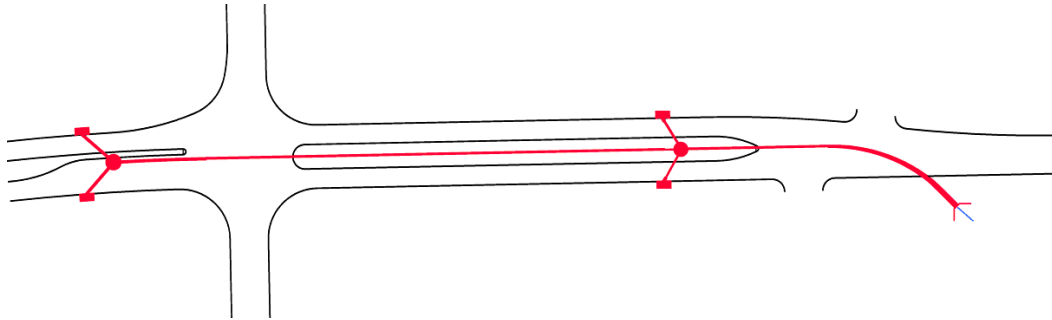

10.0 Dry Detention / Extended Detention Dry Basins

**Detention
Structural Stormwater Control**



Description: A surface storage basin or facility designed to provide water quantity control through detention and/or extended detention of stormwater runoff.

KEY CONSIDERATIONS

DESIGN CRITERIA:

- Designed for the reduction of maximum runoff values associated with development to their pre-development levels.

ADVANTAGES / BENEFITS:

- Typically less costly than stormwater (wet) ponds for equivalent flood storage, as less excavation is required
- Used in conjunction with water quality structural control
- Recreational and other open space opportunities between storm runoff events

DISADVANTAGES / LIMITATIONS:

- Controls for stormwater quantity primarily –extended detention may provide limited water quality treatment and streambank protection

**STORMWATER
MANAGEMENT SUITABILITY**

- S** Water Quality Protection
- P** Streambank Protection
- P** On-Site Flood Control
- P** Downstream Flood Control

**IMPLEMENTATION
CONSIDERATIONS**

- M** Land Requirement
- L** Capital Cost
- M** Maintenance Burden

Residential Subdivision Use: Yes

High Density/Ultra-Urban: No

Drainage Area: No restrictions.

Soils: Hydrologic group ‘A’ and ‘B’ soils may require pond liner

Other Considerations:

- Recreational and open space uses for dry detention

POLLUTANT REMOVAL

65%	Total Suspended Solids
50/30%	Nutrients - Total Phosphorus / Total Nitrogen removal
No data	Metals - Cadmium, Copper, Lead, and Zinc removal
70%	Pathogens Coliform, Streptococci, E.Coli removal

L=Low M=Moderate H=High

10.1 General Description

Dry detention and dry extended detention (ED) basins are surface facilities intended to provide for the temporary storage of stormwater runoff to reduce downstream water quantity impacts. These facilities temporarily detain stormwater runoff, releasing the flow over a period of time. They are designed to completely drain following a storm event and are normally dry between rain events.

Dry detention basins are intended to provide on-site flood control (peak flow reduction) and can be designed to control the extreme flood (flood mitigation storm) event. Extended detention dry basins provide downstream streambank protection through extended detention of the streambank protection volume (SP_v), flood control.

Both dry detention and extended detention dry basins provide limited pollutant removal benefits and are not intended for water quality treatment. Detention-only facilities must be used in a treatment train approach with other structural controls that provide full treatment of the WQ_v (see [Section 1.0](#)).

Compatible multi-objective use of dry detention facilities is strongly encouraged.

10.2 Design Criteria and Specifications

Location

Dry detention and extended detention dry basins are to be located downstream of other structural stormwater controls providing treatment of the water quality volume (WQ_v). Extended detention dry basins may be part of a treatment train which treats the WQ_v . See [Section 1.0](#) for more information on the use of multiple structural controls in a treatment train.

General Design

- Dry detention basins are sized to temporarily store the volume of runoff required to provide flood protection above the Q_f storm event up to the flood mitigation storm, if required.

Extended detention dry basins are sized to provide extended detention of the streambank protection volume over 24 hours and can also provide additional storage volume for normal detention (peak flow reduction) of the flood mitigation storm event.

Routing calculations must be used to demonstrate that the storage volume and outlet structure configuration are adequate. See [Section 2.0 of the Hydraulics Technical Manual](#) for procedures on the design of detention storage.

- Storage may be subject to the requirements of the Texas Dam Safety Program (see [iSWM Program Guidance – Dams and Reservoirs in Texas](#)) based on the volume, dam height, and level of hazard.
- Earthen embankments less than 6 feet in height that are exposed to flood waters shall have side slopes no greater than the natural angle of repose of the fill material as determined by a geotechnical study. In lieu of a geotechnical study side slopes shall be 4:1 (horizontal to vertical) maximum.
- Earthen embankments 6 feet in height or greater shall be designed per Texas Commission on Environmental Quality guidelines for dam safety (see [iSWM Program Guidance – Dams and Reservoirs in Texas](#)).
- Vegetated slopes shall be less than 20 feet in height and shall have side slopes no steeper than 2:1 (horizontal to vertical) although 3:1 is preferred. Riprap-protected slopes shall be no steeper than 2:1. Geotechnical slope stability analysis is recommended for slopes greater than 10 feet in height.
- Areas above the normal high water elevations of the detention facility should be sloped toward the basin to allow drainage and to prevent standing water. Careful finish grading is required to avoid creation of upland surface depressions that may retain runoff. The bottom area of storage facilities should be graded toward the outlet to prevent standing water conditions. A low flow or pilot channel across the facility bottom from the inlet to the outlet (often constructed with riprap) is recommended to convey low flows and prevent standing water conditions.

- Adequate maintenance access must be provided for all dry detention and extended detention dry basins.

Inlet and Outlet Structures

- Inflow channels are to be stabilized with flared riprap aprons, or the equivalent. A sediment forebay sized to 0.1 inches per impervious acre of contributing drainage should be provided for dry detention and extended detention dry basins that are in a treatment train with off-line water quality treatment structural controls.
- For a dry detention basin, the outlet structure is sized to its SP_v and Q_f functions (based upon hydrologic routing calculations) and can consist of a weir, orifice, outlet pipe, combination outlet, or other acceptable control structure. Small outlets that will be subject to clogging or are difficult to maintain are not acceptable.

For an extended detention dry basin, a low flow orifice capable of releasing WQ_v and SP_v over 24 hours must be provided. The streambank protection orifice should have a minimum diameter of 3 inches and should be adequately protected from clogging by an acceptable external trash rack. The orifice diameter may be reduced to 1 inch if internal orifice protection is used (e.g., an overperforated vertical stand pipe with 0.5-inch orifices or slots that are protected by wirecloth and a stone filtering jacket). Adjustable gate valves can also be used to achieve this equivalent diameter.

See *Section 2.2 of the Hydraulics Technical Manual* for more information on the design of outlet works.

- Seepage control or anti-seep collars should be provided for all outlet pipes.
- Riprap, plunge pools or pads, or other energy dissipators are to be placed at the end of the outlet to prevent scouring and erosion. If the basin discharges to a channel with dry weather flow, care should be taken to minimize tree clearing along the downstream channel, and to reestablish a forested riparian zone in the shortest possible distance. See *Section 4.0 of the Hydraulics Technical Manual*, for more guidance.
- An emergency spillway is to be included in the stormwater pond design to safely pass the extreme flood flow. The spillway prevents pond water levels from overtopping the embankment and causing structural damage. The emergency spillway must be designed to State of Texas guidelines for dam safety (see *iSWM Program Guidance - Dams and Reservoirs in Texas*) and must be located so that downstream structures will not be impacted by spillway discharges.
- A minimum of 1 foot of freeboard must be provided, measured from the top of the water surface elevation for the extreme flood, to the lowest point of the dam embankment not counting the emergency spillway.

10.3 Inspection and Maintenance Requirements

Table 10.1 Typical Maintenance Activities for Dry Detention / Extended Detention Dry Basins
(Source: Denver Urban Storm Drainage Manual, 1999)

Activity	Schedule
<ul style="list-style-type: none"> • Remove debris from basin surface to minimize outlet clogging and improve aesthetics. 	Annually and following significant storm events
<ul style="list-style-type: none"> • Remove sediment buildup. • Repair and revegetate eroded areas. • Perform structural repairs to inlet and outlets. 	As needed based on inspection
<ul style="list-style-type: none"> • Mow to limit unwanted vegetation. 	Routine

10.4 Example Schematics

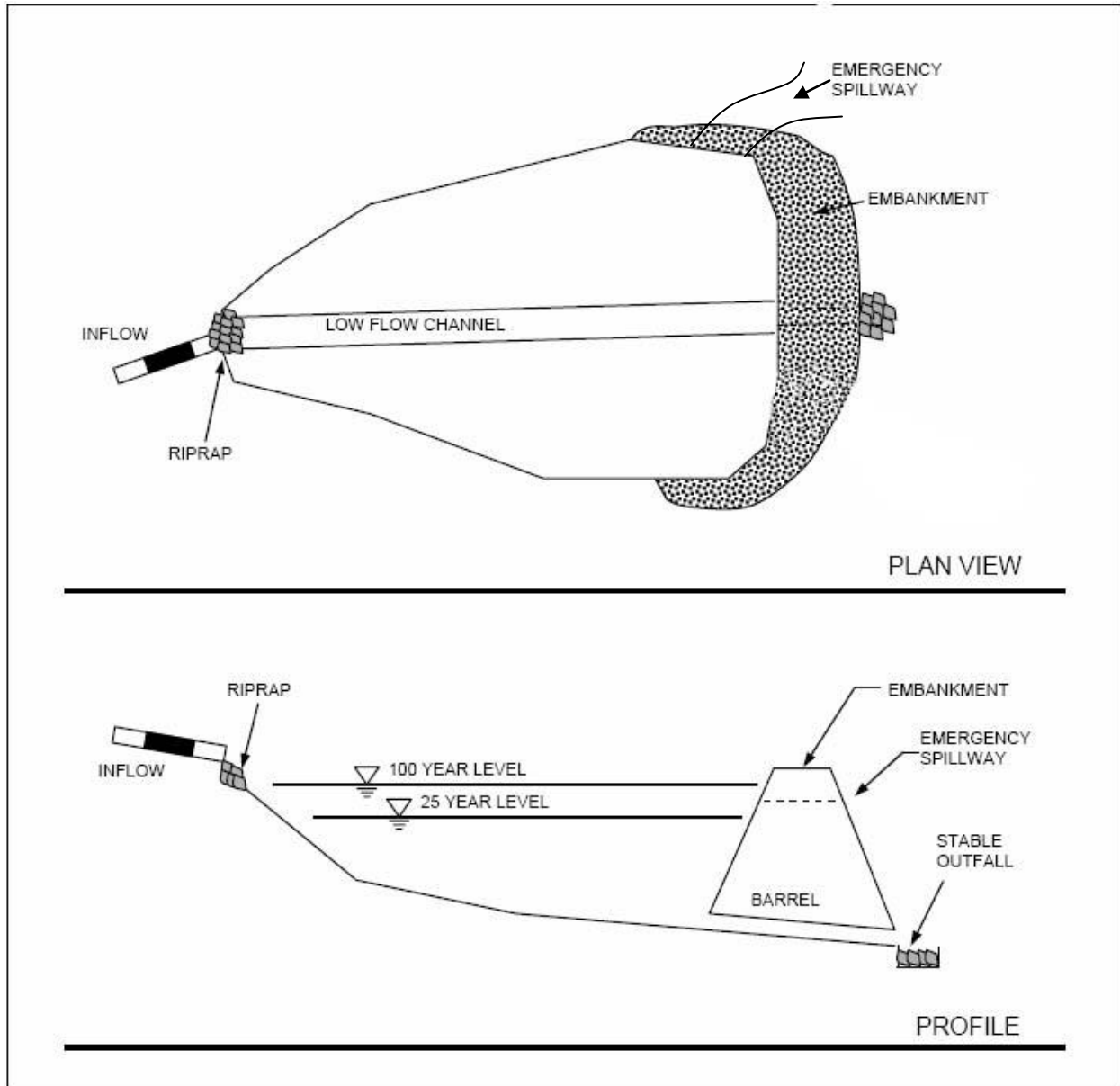

Figure 10.1 Schematic of Dry Detention Basin

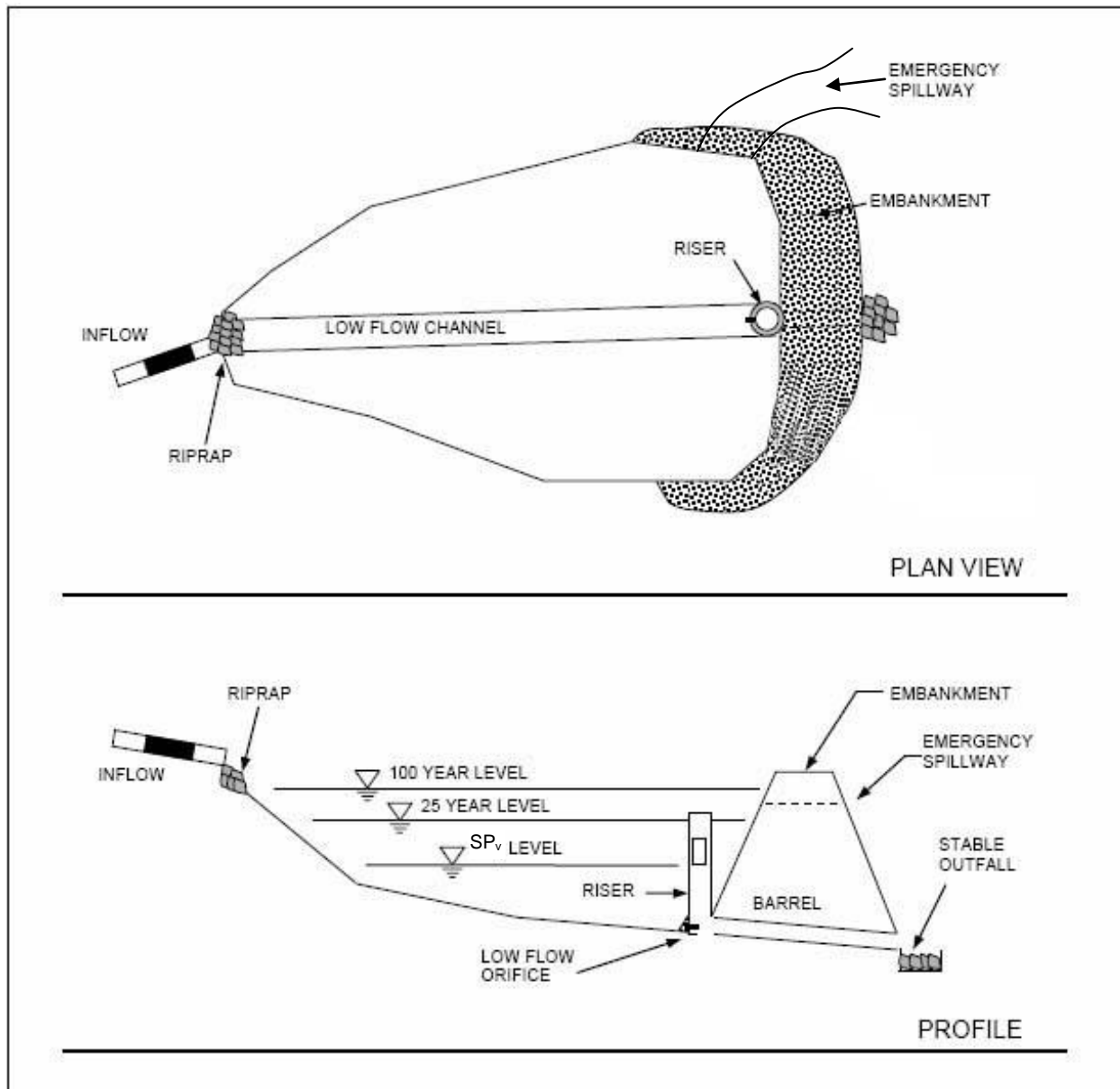

Figure 10.2 Schematic of Dry Extended Detention Basin

11.0 Multi-Purpose Detention Areas

Structural Stormwater Control



Description: A facility designed primarily for another purpose, such as parking lots and rooftops that can provide water quantity control through detention of stormwater runoff.

KEY CONSIDERATIONS

DESIGN CRITERIA:

- Adequate grading and drainage must be provided to allow full use of facility's primary purposes following a storm event

ADVANTAGES / BENEFITS:

- Allows for multiple uses of site areas and reduces the need for downstream detention facilities
- Can be used in conjunction with water quality structural control

DISADVANTAGES / LIMITATIONS:

- Controls for stormwater quantity only – not intended to provide water quality protection
- Localized flooding of area as intended may lead to property damage and additional liability

STORMWATER MANAGEMENT SUITABILITY

- Water Quality Protection
- Streambank Protection
- On-Site Flood Control
- Downstream Flood Control

IMPLEMENTATION CONSIDERATIONS

- Land Requirement
- Capital Cost
- Maintenance Burden

Residential Subdivision Use:
Yes

High Density/Ultra-Urban: Yes

Drainage Area: No restrictions.

Soils: No restrictions

L=Low M=Moderate H=High

11.1 General Description

Multi-purpose detention areas are site areas primarily used for one or more specific activities that are also designed to provide for the temporary storage of stormwater runoff to reduce downstream water quantity impacts. Example of multi-purpose detention areas include:

- Parking Lots
- Rooftops
- Sports Fields
- Recessed Plazas

Multi-purpose detention areas are normally dry between rain events, and by their very nature must be useable for their primary function the majority of the time. As such, multi-purpose detention areas should not be used for extended detention (SP_v control).

Multi-purpose detention areas are not intended for water quality protection and must be used in a treatment train approach with other structural controls that provide treatment of the WQ_v (see [Section 1.6](#)).

11.2 Design Criteria and Specifications

Location

Multi-purpose detention areas can be located upstream or downstream of other structural stormwater controls providing treatment of the water quality protection volume (WQ_v). See the [Section 1.6](#) for more information on the use of multiple structural controls in a treatment train.

General Design

Multi-purpose detention areas are sized to temporarily store a portion or all of the volume of runoff required to control the flood mitigation storm, if required.

Routing calculations must be used to demonstrate that the storage volume is adequate. See [Section 2.0 of the Hydraulics Technical Manual](#) for procedures on the design of detention storage.

All multi-purpose detention facilities must be designed to minimize potential safety risks, potential property damage, and inconvenience to the facility's primary purposes. Emergency overflows are to be provided for storm events larger than the design storm. The overflow must not create a significant adverse impact to downstream properties or the conveyance system.

Parking Lot Storage

Parking lot detention can be implemented in areas where portions of large, paved lots can be temporarily used for runoff storage without significantly interfering with normal vehicle and pedestrian traffic. Parking lot detention can be created in two ways: by using ponding areas along sections of raised curbing, or through depressed areas of pavement at drop inlet locations.

The maximum depth of detention ponding in a parking lot, except at a flow control structure, should be 6 inches for a 10-year storm, and 9 inches for a flood mitigation storm. The maximum depth of ponding at a flow control structure is 12 inches for a flood mitigation storm.

The storage area (portion of the parking lot subject to ponding) must have a minimum slope of 0.5% towards the outlet to ensure complete drainage following a storm. A slope of 1% or greater is recommended.

Fire lanes used for emergency equipment must be free of ponding water for runoff events up to the extreme storm (flood mitigation storm) event.

Flows are typically backed up in the parking lot using a wye inlet.

Rooftop Storage

Rooftops can be used for detention storage as long as the roof support structure is designed to address the weight of ponded water and is sufficiently waterproofed to achieve a minimum service life of 30 years. All rooftop detention designs must meet Texas State Building Code and local building code requirements.

The minimum pitch of the roof area subject to ponding is 0.25 inches per foot.

The rooftop storage system must include another mechanism for draining the ponding area in the event that the primary outlet is clogged.

Sports Fields

Athletic facilities such as football and soccer fields and tracks can be used to provide stormwater detention. This is accomplished by constructing berms around the facilities, which in essence creates very large detention basins. Outflow can be controlled through the use of an overflow weir or other appropriate control structure. Proper grading must be performed to ensure complete drainage of the facility.

Public Plazas

In high-density areas, recessed public common areas such as plazas and pavilions can be utilized for stormwater detention. These areas can be designed to flood no more than once or twice annually, and provide important open recreation space during the rest of the year.

11.3 Inspection and Maintenance Requirements

Table 11.1 Typical Maintenance Activities for Multi-Purpose Detention Areas	
Activity	Schedule
<ul style="list-style-type: none"> Remove debris from ponding area to minimize outlet clogging and improve aesthetics. 	Annually and following significant storm events
<ul style="list-style-type: none"> Remove sediment buildup. Repair and revegetate eroded areas. Perform structural repairs to inlet and outlets. 	As needed based on inspection
<ul style="list-style-type: none"> Perform additional maintenance activities specific to the type of facility. 	As required
(Based on: Denver Urban Storm Drainage Manual, 1999)	

12.0 Underground Detention

**Detention
Structural Stormwater Control**



Description: Detention storage located in underground pipe/tank systems or vaults designed to provide water quantity control through detention and/or extended detention of stormwater runoff.

KEY CONSIDERATIONS

ADVANTAGES / BENEFITS:

- Does not take up surface space
- Used in conjunction with water quality structural control
- Concrete vaults or pipe/tank systems can be used

DISADVANTAGES / LIMITATIONS:

- Controls for stormwater quantity only – not intended to provide water quality treatment
- Intended for space-limited applications
- High initial construction cost as well as replacement cost at the end of its economic life

**STORMWATER
MANAGEMENT SUITABILITY**

- Water Quality Protection
- Streambank Protection
- On-Site Flood Control
- Downstream Flood Control

**IMPLEMENTATION
CONSIDERATIONS**

- Land Requirement
- Capital Cost
- Maintenance Burden

Residential Subdivision Use: No
High Density/Ultra-Urban: Yes
Drainage Area: 160 acres max.
Soils: No restrictions

L=Low M=Moderate H=High

12.1 General Description

Detention vaults are box-shaped underground stormwater storage facilities typically constructed with reinforced concrete. Detention pipe/tank systems are underground storage facilities typically constructed with large diameter metal or plastic pipe. Both serve as an alternative to surface dry detention for stormwater quantity control, particularly for space-limited areas where there is not adequate land for a dry detention basin or multi-purpose detention area.

Both underground vaults and pipe/tank systems can provide streambank protection through extended detention of the streambank protection volume (SP_v), and flood (in some cases extreme flood Q_f) control through normal detention. Basic storage design and routing methods are the same as for detention basins except that the bypass for high flows is typically included.

Underground detention vaults and pipe/tank systems are not intended for water quality treatment and must be used in a treatment train approach with other structural controls that provide treatment of the WQ_v (see [Section 1.6](#)). This will prevent the underground vault or tank from becoming clogged with trash or sediment and significantly reduces the maintenance requirements for an underground detention system.

Prefabricated concrete vaults are available from commercial vendors. In addition, several pipe manufacturers have developed packaged detention systems.

12.2 Design Criteria and Specifications

Location

Underground detention systems are to be located downstream of other structural stormwater controls providing treatment of the water quality volume (WQ_v). See [Section 1.6](#) for more information on the use of multiple structural controls in a treatment train.

The maximum contributing drainage area to be served by a single underground detention vault or tank is 200 acres.

General Design

Underground detention systems are sized to provide extended detention of the streambank protection volume over 24 hours and temporarily store the volume of runoff required to provide the desired flood protection.

Routing calculations must be used to demonstrate that the storage volume is adequate. See [Section 2.0 of the Hydraulics Technical Manual](#) for procedures on the design of detention storage.

Detention Vaults: Minimum 3,000 psi structural reinforced concrete may be used for underground detention vaults. All construction joints must be provided with water stops. Cast-in-place wall sections must be designed as retaining walls. The maximum depth from finished grade to the vault invert should be 20 feet.

Detention Pipe/Tank Systems: The minimum pipe diameter for underground detention tanks is 36 inches.

Underground detention vaults and pipe/tank systems must meet structural requirements for overburden support and traffic loading if appropriate.

Adequate maintenance access must be provided for all underground detention systems. Access must be provided over the inlet pipe and outflow structure. Access openings can consist of a standard frame, grate and solid cover, or a removable panel. Vaults with widths of 10 feet or less should have removable lids.

Inlet and Outlet Structures

- A separate sediment sump or vault chamber sized to 0.1 inches per impervious acre of contributing drainage should be provided at the inlet for underground detention systems that are in a treatment train with off-line water quality treatment structural controls.

- For SP_v control, a low flow orifice capable of releasing the streambank protection volume over 24 hours must be provided. The streambank protection orifice should have a minimum diameter of 3 inches and should be adequately protected from clogging by an acceptable external trash rack. The orifice diameter may be reduced to 1 inch if internal orifice protection is used (i.e., an overperforated vertical stand pipe with 0.5-inch orifices or slots that are protected by wirecloth and a stone filtering jacket). Adjustable gate valves can also be used to achieve this equivalent diameter.

For on-site flood control, an additional outlet is sized for control of the chosen return period (based upon hydrologic routing calculations) and can consist of a weir, orifice, outlet pipe, combination outlet, or other acceptable control structure.

See [Section 2.2 of the Hydraulics Technical Manual](#) for more information on the design of outlet works.

- Riprap, plunge pools or pads, or other energy dissipators are to be placed at the end of the outlet to prevent scouring and erosion. See [Section 4.0 of the Hydraulics Technical Manual](#), for more guidance.
- A high flow bypass is to be included in the underground detention system design to safely pass the extreme flood flow.

12.3 Inspection and Maintenance Requirements

Activity	Schedule
<ul style="list-style-type: none"> • Remove any trash/debris and sediment buildup in the underground vaults or pipe/tank systems. 	Annually
<ul style="list-style-type: none"> • Perform structural repairs to inlet and outlets. 	As needed, based on inspection

12.4 Example Schematics

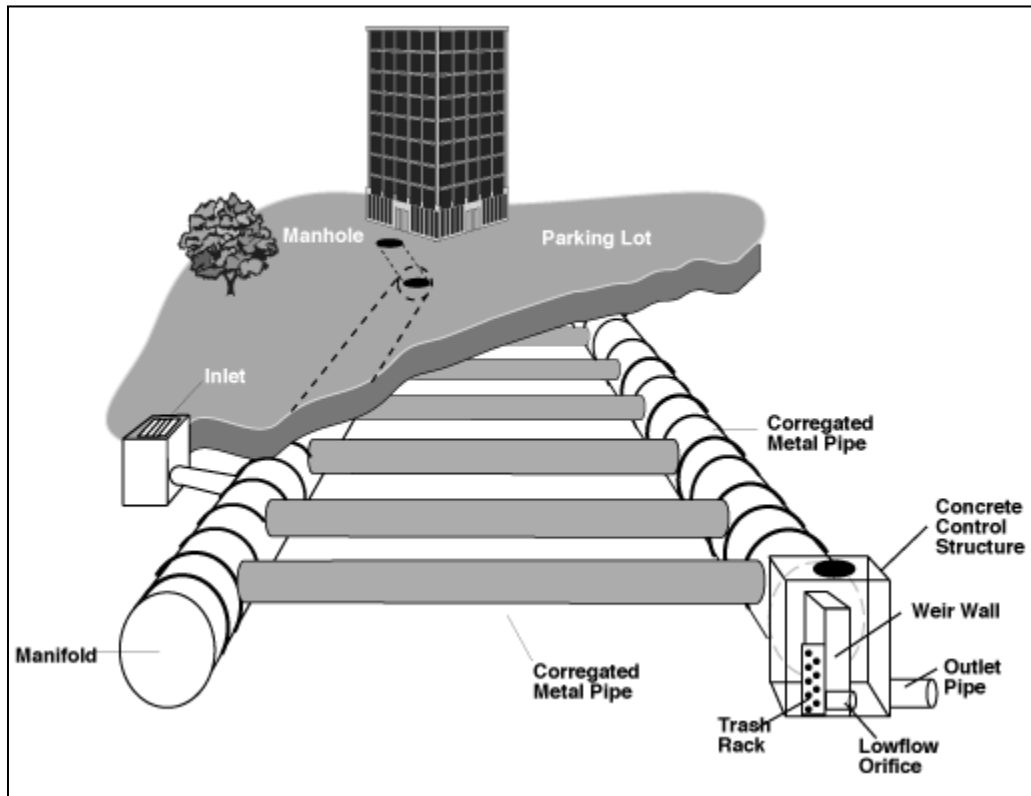

Figure 12.1 Example Underground Detention Tank System

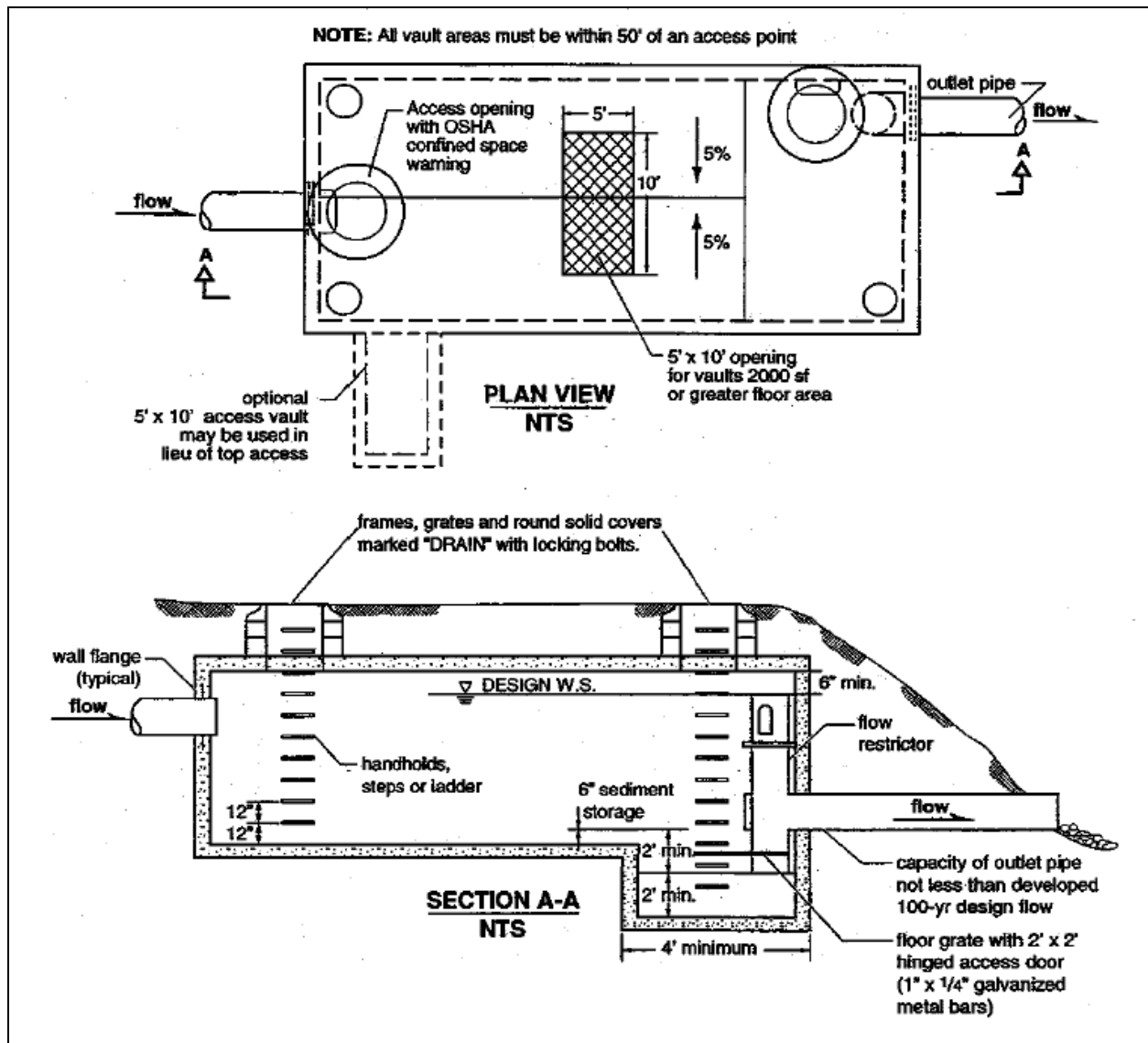

Figure 12.2 Schematic of Typical Underground Detention Vault

(Source: WDE, 2000)

13.0 Filter Strip

Structural Stormwater Control



Description: Filter strips are uniformly graded and densely vegetated sections of land engineered and designed to treat runoff from and remove pollutants through vegetative filtering and infiltration.

KEY CONSIDERATIONS

DESIGN CRITERIA:

- Runoff from an adjacent impervious area must be evenly distributed across the filter strip as sheet flow

ADVANTAGES / BENEFITS:

- Can be used as part of the runoff conveyance system to provide pretreatment
- Can provide groundwater recharge
- Reasonably low construction cost

DISADVANTAGES / LIMITATIONS:

- Cannot alone achieve the 80% TSS removal target
- Large land requirement

MAINTENANCE REQUIREMENTS:

- Requires periodic repair, regrading, and sediment removal to prevent channelization

STORMWATER MANAGEMENT SUITABILITY

- S** Water Quality Protection
- Streambank Protection**
- On-Site Flood Control**
- Downstream Flood Control**

IMPLEMENTATION CONSIDERATIONS

- H** Land Requirement
- L** Capital Cost
- M** Maintenance Burden

Residential Subdivision Use: Yes

High Density/Ultra-Urban: No

Drainage Area: 2 acres max.

Soils: No restrictions

Other Considerations:

- Use in buffer system
- Treating runoff from pervious areas

POLLUTANT REMOVAL

- 50%** **Total Suspended Solids**
- 20/20%** **Nutrients** - Total Phosphorus / Total Nitrogen removal
- 40%** **Metals** - Cadmium, Copper, Lead, and Zinc removal
- No data** **Pathogens** - Coliform, Streptococci, E.Coli removal

L=Low M=Moderate H=High

13.1 General Description

Filter strips are uniformly graded and densely vegetated sections of land engineered and designed to treat runoff and remove pollutants through vegetative filtering and infiltration. Filter strips are best suited to treating runoff from roads and highways, roof downspouts, very small parking lots, and pervious surfaces. They are also ideal components of the "outer zone" of a stream buffer, or as pretreatment for another structural stormwater control. Filter strips can serve as a buffer between incompatible land uses, be landscaped to be aesthetically pleasing, and provide groundwater recharge in areas with pervious soils. Filter strips are often used as an *integrated* site design reduction credit (see [Section 13.0](#) for more information).

Filter strips rely on the use of vegetation to slow runoff velocities and filter out sediment and other pollutants from urban stormwater. There can also be a significant reduction in runoff volume for smaller flows that infiltrate pervious soils while contained within the filter strip. To be effective, however, sheet flow must be maintained across the entire filter strip. Once runoff flow concentrates, it effectively short-circuits the filter strip and reduces any water quality benefits. Therefore, a flow spreader must normally be included in the filter strip design.

There are two different filter strip designs: a simple filter strip and a design that includes a permeable berm at the bottom. The presence of the berm increases the contact time with the runoff, thus reducing the overall width of the filter strip required to treat stormwater runoff. Filter strips are typically an on-line practice, so they must be designed to withstand the full range of storm events without eroding.

13.2 Pollutant Removal Capabilities

Pollutant removal from filter strips is highly variable and depends primarily on density of vegetation and contact time for filtration and infiltration. These, in turn, depend on soil and vegetation type, slope, and presence of sheet flow.

The following design pollutant removal rates are conservative average pollutant reduction percentages for design purposes derived from sampling data, modeling and professional judgment.

- Total Suspended Solids – 50%
- Total Phosphorus – 20%
- Total Nitrogen – 20%
- Fecal Coliform – insufficient data
- Heavy Metals – 40%

13.3 Design Criteria and Specifications

General Criteria

Filter strips should be used to treat small drainage areas. Flow must enter the filter strip as sheet flow spread out over the width (long dimension normal to flow) of the strip, generally no deeper than 1 to 2 inches. As a rule, flow concentrates within a maximum of 75 feet for impervious surfaces, and 150 feet for pervious surfaces (CWP, 1996). For longer flow paths, special provision must be made to ensure design flows spread evenly across the filter strip, instead of becoming concentrated.

Filter strips should be integrated within site designs.

Filter strips should be constructed outside the natural stream buffer area whenever possible to maintain a more natural buffer along the streambank.

Filter strips should be designed for slopes between 2% and 6%. Greater slopes than this would encourage the formation of concentrated flow. Flatter slopes would encourage standing water.

Filter strips should not be used on soils that cannot sustain a dense grass cover with high retardance. Designers should choose a grass that can withstand relatively high velocity flows at the entrances, and

both wet and dry periods. See [Section 1.0 of the Landscape Technical Manual](#) for a list of appropriate grasses for use in North Central Texas.

The flow path should be at least 15 feet across the strip to provide filtration and contact time for water quality treatment. Twenty-five (25) feet is preferred (where available), though the length of the flow path will normally be dictated by design method.

Both the top and toe of the slope should be as flat as possible to encourage sheet flow and prevent erosion.

An effective flow spreader is a pea gravel diaphragm at the top of the slope (ASTM D 448 size no. 6, 1/8" to 3/8"). The pea gravel diaphragm (a small trench running along the top of the filter strip) serves two purposes. First, it acts as a pretreatment device, settling out sediment particles before they reach the practice. Second it acts as a level spreader, maintaining sheet flow as runoff flows over the filter strip. Other types of flow spreaders include a concrete sill, curb stops, or curb and gutter with "sawteeth" cut into it.

Ensure that flows in excess of design flow move across or around the strip without damaging it. Often a bypass channel or overflow spillway with protected channel section is designed to handle higher flows.

Pedestrian traffic across the filter strip should be limited through channeling onto sidewalks.

Maximum discharge loading per foot of filter strip width (perpendicular to flow path) is found using the Manning's Equation:

$$q = \frac{0.023}{n} Y^{\frac{5}{3}} S^{\frac{1}{2}} \quad (13.1)$$

where:

q = discharge per foot of width of filter strip (cfs/ft)

Y = allowable depth of flow (inches)

S = slope of filter strip (percent)

N = Manning's "n" roughness coefficient

(use 0.15 for medium grass, 0.25 for dense grass, and 0.35 for very dense Bermuda-type grass)

The minimum width of a filter strip is:

$$W_{\text{MIN}} = \frac{Q}{q} \quad (13.2)$$

where:

W_{MIN} = minimum filter strip width perpendicular to flow (feet)

Filter without Berm

Size filter strip (parallel to flow path) for a contact time of 5 minutes minimum

Equation for filter length is based on the SCS TR55 travel time equation (SCS, 1986):

$$L_f = \frac{(T_t)^{1.25} (P_{2-24})^{0.625} (S)^{1/2}}{3.34n} \quad (13.3)$$

L_f = length of filter strip parallel to flow path (ft)

T_t = travel time through filter strip (minutes)

P_{2-24} = 2-year, 24-hour rainfall depth (inches)

S = slope of filter strip (percent)

n = Manning's "n" roughness coefficient

(use 0.15 for medium grass, 0.25 for dense grass, and 0.35 for very dense Bermuda-type grass)

Filter Strips with Berm

Size outlet pipes to ensure that the bermed area drains within 24 hours.

Specify grasses resistant to frequent inundation within the shallow ponding limit.

Berm material should be of sand, gravel and sandy loam to encourage grass cover (Sand: ASTM C-33 fine aggregate concrete sand 0.02"-0.04", Gravel: AASHTO M-43 ½" to 1").

Size filter strip to contain the WQ_v within the wedge of water backed up behind the berm.

Maximum berm height is 12 inches.

Filter Strips for Pretreatment

A number of other structural controls, including bioretention areas and infiltration trenches, may utilize a filter strip as a pretreatment measure. The required length of the filter strip flow path depends on the drainage area, imperviousness, and the filter strip slope. Table 13.1 provides sizing guidance for bioretention filter strips for pretreatment.

Parameter	Impervious Areas				Pervious Areas (Lawns, etc)			
	Maximum inflow approach length (feet)	35		75		75		100
Filter strip slope (max = 6%)	< 2%	> 2%	< 2%	> 2%	< 2%	> 2%	< 2%	> 2%
Filter strip minimum length (feet)	10	15	20	25	10	12	15	18

(Source: Claytor and Schueler, 1996)

13.4 Inspection and Maintenance Requirements

Activity	Schedule
<ul style="list-style-type: none"> Mow grass to maintain a 2 to 4 inch height. 	Regularly (frequently)
<ul style="list-style-type: none"> Inspect pea gravel diaphragm for clogging and remove built-up sediment. Inspect vegetation for rills and gullies and correct. Seed or sod bare areas. Inspect to ensure that grass has established. If not, replace with an alternative species. 	Annual Inspection (Semi-annual first year)

(Source: CWP, 1996)

If berm is used per example, inspect outlet pipes for clogging

Additional Maintenance Considerations and Requirements

Filter strips require similar maintenance to other vegetative practices. Maintenance is very important for filter strips, particularly in terms of ensuring that flow does not short circuit the practice.

13.5 Example Schematic

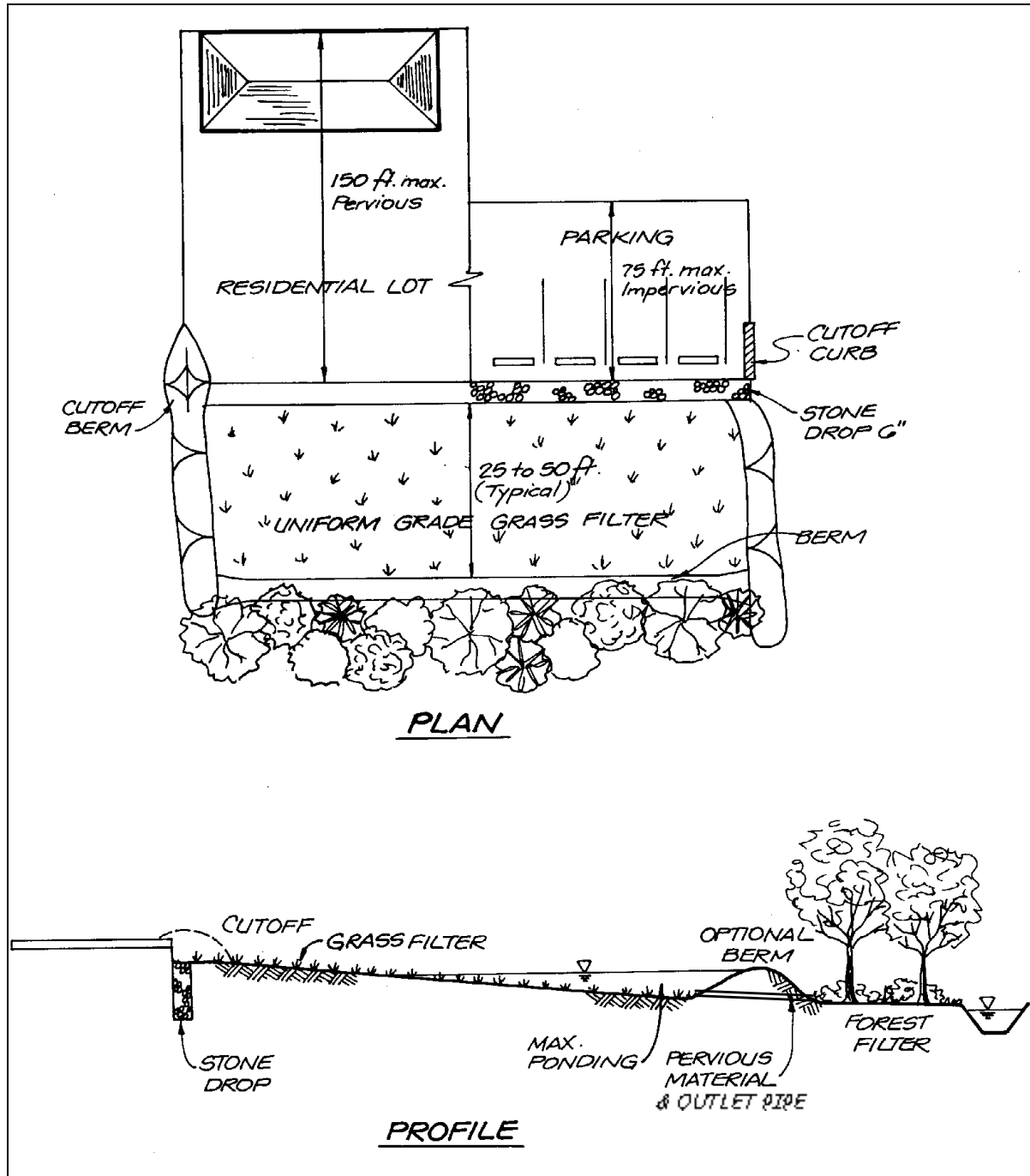

Figure 13.1 Schematic of Filter Strip (with Berm)

13.6 Design Example

Basic Data

Small commercial lot 150 feet deep x 100 feet wide located in Denison

- Drainage area (A) = 0.34 acres
- Impervious percentage (I) = 70%
- Slope equals 4%, Manning's n = 0.25

Calculate Maximum Discharge Loading Per Foot of Filter Strip Width

Using Equation 13.1:

$$q = 0.0237/0.25 * (1.0)^{5/3} * (4)^{1/2} = 0.19 \text{ cfs/ft}$$

Water Quality Peak Flow

See *Section 1.4 of the Water Quality Technical Manual* for details

Compute the Water Quality Volume in inches:

$$WQv = 1.5 (0.05 + 0.009 * 70) = 1.02 \text{ inches}$$

Compute modified CN for 1.5-inch rainfall (P=1.5):

$$\begin{aligned} CN &= 1000/[10+5P+10Q-10(Q2+1.25*Q*P)^{1/2}] \\ &= 1000/[10+5*1.5+10*0.82-10(0.822+1.25*0.82*1.5)^{1/2}] \\ &= 92.4 \text{ (Use CN = 92)} \end{aligned}$$

For CN = 92 and an estimated time of concentration (T_c) of 8 minutes (0.13 hours), compute the Q_{wq} for a 1.5-inch storm.

From *Table 1.11 in the Hydrology Technical Manual*, $I_a = 0.174$, therefore $I_a/P = 0.174/1.5 = 0.116$.

From *Figure 1.10 in the Hydrology Technical Manual* for a Type II storm (using the limiting values) $q_u = 950 \text{ csm/in}$, and therefore:

$$Q_{wq} = (950 \text{ csm/in}) (0.34\text{ac}/640\text{ac}/\text{mi}^2) (1.02") = 0.51 \text{ cfs}$$

Minimum Filter Width

Using Equation 13.2:

$$W_{\text{MIN}} = Q/q = 0.51/0.19 = 2.7 \text{ feet}$$

Since the width of the lot is 100 feet, the actual width of the filter strip will depend on site grading and the ability to deliver the drainage to the filter strip in sheet flow through a pea gravel filled trench.

Filter without Berm

- 2-year, 24-hour storm (see *Section 5.0 of the Hydrology Technical Manual*) = 0.17 in/hr or 0.17*24= 4.08 inches
- Use 5 minute travel (contact) time

Using Equation 13.3:

$$L_f = (5)1.25 * (4.08)0.625 * (4)0.5 / (3.34 * 0.25) = 43 \text{ feet}$$

Note: Reducing the filter strip slope to 2% and planting a denser grass (raising the Manning n to 0.35) would reduce the filter strip length to 22 feet. Sensitivity to slope and Manning's n changes are illustrated for this example in Figure 13.2.

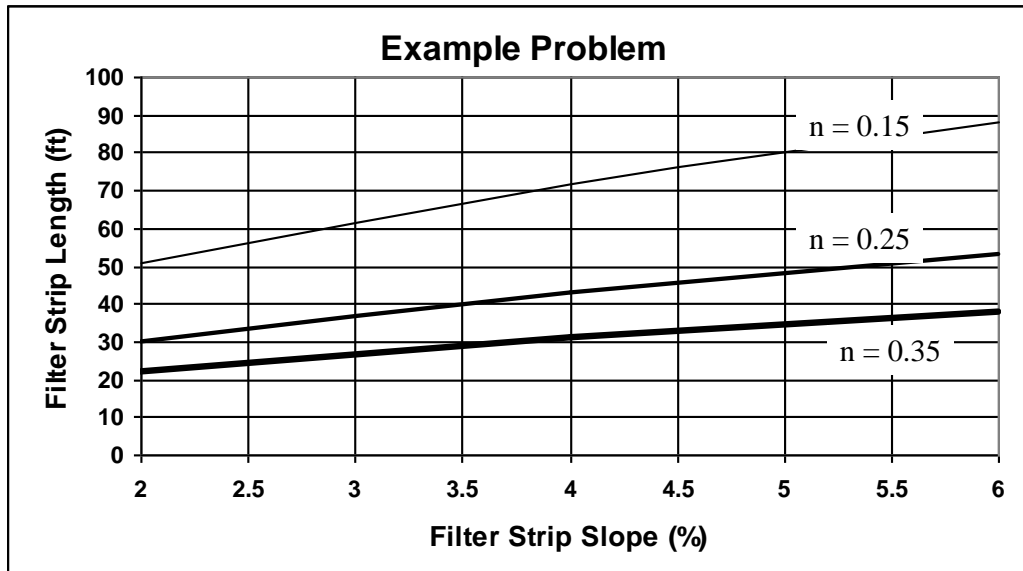

Figure 13.2 Example Problem Sensitivity of Filter Strip Length to Slope and Manning's n Values

Filter With Berm

- Pervious berm height is 6 inches

Compute the Water Quality Volume in cubic feet:

$$WQv = Rv * 1.5/12 * A = (0.05 + 0.009 * 70) * 1.5/12 * 0.34 = 0.029 \text{ Ac-ft or } 1,259 \text{ ft}^3$$

For a berm height of 6 inches the "wedge" of volume captured by the filter strip is:

$$\text{Volume} = Wf * 0.5 * Lf * 0.5 = 0.25WfLf = 1,259 \text{ ft}^3$$

For a maximum width of the filter of 100 feet, the length of the filter would then be 50 feet.

For a 1-foot berm height, the length of the filter would be 25 feet.

14.0 Organic Filter

Structural Stormwater Control



Description: Design variant of the surface sand filter using organic materials in the filter media.

KEY CONSIDERATIONS

DESIGN CRITERIA:

- Minimum head requirement of 5 to 8 feet

ADVANTAGES / BENEFITS:

- High pollutant removal capability
- Removal of dissolved pollutants is greater than sand filters due to cation exchange capacity

DISADVANTAGES / LIMITATIONS:

- Severe clogging potential if exposed soil surfaces exist upstream
- Intended for hotspot or space-limited applications, or for areas requiring enhanced pollutant removal capability
- High maintenance requirements
- Filter may require more frequent maintenance than most of the other stormwater controls

STORMWATER MANAGEMENT SUITABILITY

- Water Quality Protection**
- Streambank Protection**
- On-Site Flood Control**
- Downstream Flood Control**

IMPLEMENTATION CONSIDERATIONS

- Land Requirement**
- Capital Cost**
- Maintenance Burden**

Residential Subdivision Use: No
High Density/Ultra-Urban: Yes
Drainage Area: 10 acres max.
Soils: No restrictions
Other Considerations:

- Hotspot areas

L=Low M=Moderate H=High

POLLUTANT REMOVAL

- 80% Total Suspended Solids**
- 60/40% Nutrients** - Total Phosphorus / Total Nitrogen removal
- 75% Metals** - Cadmium, Copper, Lead, and Zinc removal
- 50% Pathogens** - Coliform, Streptococci, E.Coli removal

14.1 General Description

The organic filter is a design variant of the surface sand filter, which uses organic materials such as leaf compost or a peat/sand mixture as the filter media. The organic material enhances pollutant removal by providing adsorption of contaminants such as soluble metals, hydrocarbons, and other organic chemicals.

As with the surface sand filter, an organic filter consists of a pretreatment chamber, and one or more filter cells. Each filter bed contains a layer of leaf compost or the peat/sand mixture, followed by filter fabric and a gravel/perforated pipe underdrain system. The filter bed and subsoils can be separated by an impermeable polyliner or concrete structure to prevent movement into groundwater.

Organic filters are typically used in high-density applications, or for areas requiring enhanced pollutant removal ability. Maintenance is typically higher than the surface sand filter facility due to the potential for clogging. In addition, organic filter systems have a higher head requirement than sand filters.

14.2 Pollutant Removal Capabilities

Peat/sand filter systems provide good removal of bacteria and organic waste metals. The following design pollutant removal rates are conservative average pollutant reduction percentages for design purposes derived from sampling data, modeling and professional judgment. (Note: In some cases, organic materials may be a source of soluble phosphorus and nitrates.)

- Total Suspended Solids – 80%
- Total Phosphorus – 60%
- Total Nitrogen – 40%
- Fecal Coliform – 50%
- Heavy Metals – 75%

14.3 Design Criteria and Specifications

Organic filters are typically used on relatively small sites (up to 10 acres), to minimize potential clogging.

The minimum head requirement (elevation difference needed at a site from the inflow to the outflow) for an organic filter is 5 to 8 feet.

Organic filters can utilize a variety of organic materials as the filtering media. Two typical media bed configurations are the peat/sand filter and compost filter (see Figure 14.1). The peat filter includes an 18-inch 50/50 peat/sand mix over a 6-inch sand layer and can be optionally covered by 3 inches of topsoil and vegetation. The compost filter has an 18-inch compost layer. Both variants utilize a gravel underdrain system.

The type of peat used in a peat/sand filter is critically important. Fibric peat in which undecomposed fibrous organic material is readily identifiable is the preferred type. Hemic peat containing more decomposed material may also be used. Sapric peat made up of largely decomposed matter should *not* be used in an organic filter.

Typically, organic filters are designed as "off-line" systems, meaning that the water volume (WQ_v) is diverted to the filter facility through the use of a flow diversion structure and flow splitter. Stormwater flows greater than the WQ_v are diverted to other controls or downstream using a diversion structure or flow splitter.

Consult the design criteria for the surface sand filter (see [Section 16.0 on Sand Filters](#)) for the organic filter sizing and design steps.

14.4 Inspection and Maintenance Requirements

The inspection and maintenance requirements for organic filters are similar to those for surface sand filter facilities (see [Section 16.0 on Sand Filters](#))

14.5 Example Schematic

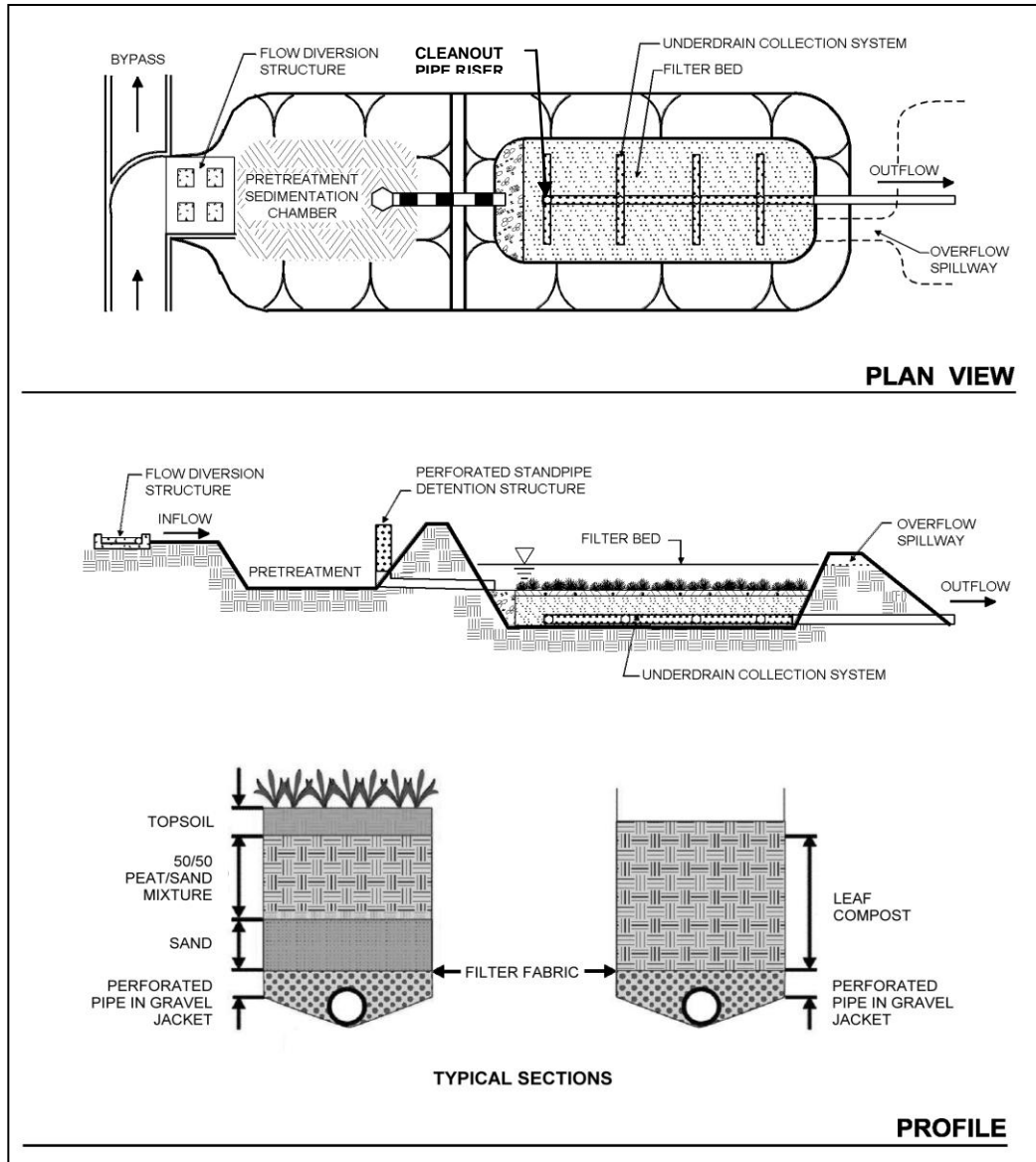

Figure 14.1 Schematic of Organic Filter
 (Source: Center for Watershed Protection)

15.0 Planter Boxes

Structural Stormwater Control



Description: Planter boxes are used on impervious surfaces in highly urbanized areas to collect and detain / infiltrate rainfall and runoff. The boxes may be prefabricated or constructed in place and contain growing medium, plants, and a reservoir.

KEY CONSIDERATIONS

DESIGN CRITERIA:

- Planter boxes should not be used for stormwater containing high sediment loads to minimize clogging potential

ADVANTAGES / BENEFITS:

- Filtration provides pollutant removal capability
- Reservoir decreases peak flow rates

DISADVANTAGES / LIMITATIONS:

- Intended for space-limited applications, or for areas requiring additional pollutant removal capability
- Limited data on pollutant removal effectiveness

MAINTENANCE REQUIREMENTS:

- Vegetation will require frequent maintenance
- Filter may require more frequent maintenance than most of the other stormwater controls

POLLUTANT REMOVAL

80%	Total Suspended Solids
60/40%	Nutrients - Total Phosphorus / Total Nitrogen removal
No data	Metals - Cadmium, Copper, Lead, and Zinc removal
No data	Pathogens - Coliform, Streptococci, E.Coli removal

STORMWATER MANAGEMENT SUITABILITY

- Water Quality Protection**
- Streambank Protection**
- On-Site Flood Control**
- Downstream Flood Control**

IMPLEMENTATION CONSIDERATIONS

- Land Requirement**
- Capital Cost**
- Maintenance Burden**

Residential Subdivision Use: No

High Density/Ultra-Urban: Yes

Drainage Area: No restrictions

Soils: No restrictions

L=Low M=Moderate H=High

15.1 General Description

Planter boxes are essentially large pots filled with soil or other growing media. There are several variations of this basic design. The contained planter box receives only rainfall, which filters through the soil and is then either taken up by its vegetation or allowed to seep out the bottom of the planter to the pavement or sidewalk. The infiltration planter box can receive both rainfall and runoff, which eventually filters through the bottomless planter and enters the underlying soil. The flow-through planter box collects flow in a perforated pipe along the bottom of the box and discharges out the side of the planter or into a storm sewer.

Each of the three planter box types has certain advantages and drawbacks:

- The contained planter is not tied into underlying soil or pipes and can therefore be placed almost anywhere and moved when needed. However, it does not have a reservoir to provide additional storage for flow control. Care should also be used in placing it next to building foundations and heavy pedestrian traffic areas.
- The infiltration planter should not be used next to foundations and underlying soils must drain rapidly enough to avoid ponding.
- The flow-through planter can be used next to building foundations since it directs flow off to the side and away from the building. It must be located next to a suitable discharge point into the stormwater conveyance system.

15.2 Pollutant Removal Capabilities

Field tests of planters are lacking, however, tests of a bioretention cell by the EPA showed results that were generally similar to those of the Organic Filter, with somewhat less metals removal (43-78%).

15.3 Design Criteria and Specifications

The infiltration and flow-through planter boxes can capture runoff from surrounding areas and provide limited storage in reservoirs. The ratio of planter area to impervious area should be 7%, assuming a storm volume of 1.5 inches and a reservoir depth in the planter of 12 inches.

The planter should be constructed of stone, concrete, or brick. Pressure-treated wood may be used if it does not leach out toxic chemicals that might contaminate stormwater.

Filter media should consist of sand, gravel and topsoil as shown in Figures 15.1-15.3. As an alternative, compost/mulch can be used in place of the sand, gravel, and topsoil, but will have different infiltration characteristics. Compost with organics will aid in pollutant removal through absorption, but it will remove nitrogen from the plant material as it breaks down/decomposes. A nitrogen fertilizer may need to be added should this occur.

Planter vegetation should be relatively self-sustaining, with minimal fertilizer or pesticide requirements. Grasses, herbs, succulents, shrubs, and trees may be used in planter boxes. Examples include rushes, reeds, sedges, iris, dogwood, currants, and other approved species. Trees are encouraged as their foliage traps additional precipitation.

All of the planters require 18 inches of growing media. The contained planter does not require a minimum width. A minimum width of 30 inches is recommended for the infiltration planter. The flow-through planter should be at least 18 inches wide. The minimum widths help reduce water wicking down the insides of the planter wall.

Water should drain through a planter within 3-4 hours after the storm event.

Soils underneath an infiltration planter should be SCS Hydrologic Type A or B.

15.4 Inspection and Maintenance Requirements

The inspection and maintenance requirements for planter boxes focus on maintaining an adequate drainage rate through the planting media and attractive and healthy vegetation.

Activity	Schedule
<ul style="list-style-type: none"> • Ensure that downspout or sheet flow from paving is unimpeded. • Ensure planter reservoir drains within 3-4 hours. • Replace or amend topsoil if drainage unsatisfactory. 	Quarterly and within 48 hours of major storms
<ul style="list-style-type: none"> • Ensure that contributing area and planter boxes are clear of debris. • Remove accumulated sediment if greater than 4 inches in depth. • Ensure that planter vegetation is healthy and planter is weeded and shrubs and trees pruned. • Planter vegetation may require watering during long dry spells. 	As needed, based on inspection
<ul style="list-style-type: none"> • Fallen leaves and debris from deciduous plants should be removed. 	Three to four times a year
<ul style="list-style-type: none"> • Replenish mulch. • Training/written materials provided to property owners and tenants. 	Annually
<ul style="list-style-type: none"> • Replace planter if cracked or rotted. 	Upon failure

15.5 Example Schematics

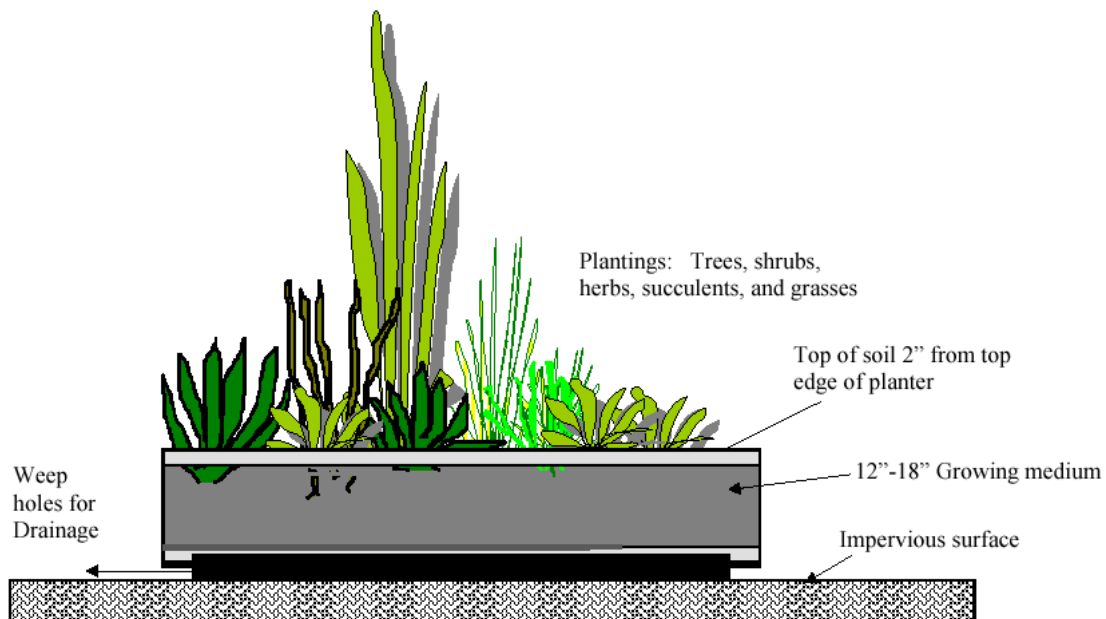

Section Not to Scale

Figure 15.1 Schematic of Contained Planter Box

(Source: City of Portland, Oregon)

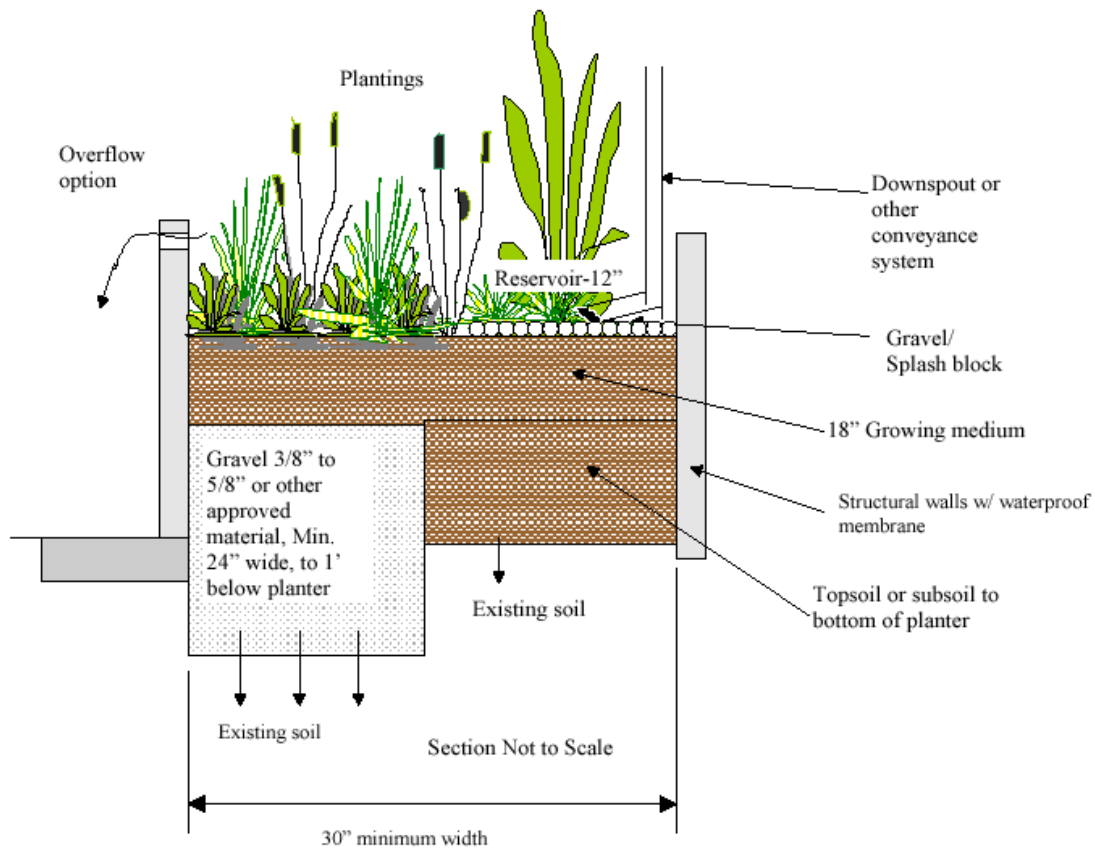

Figure 15.2 Schematic of Infiltration Planter Box
 (Source: City of Portland, Oregon)

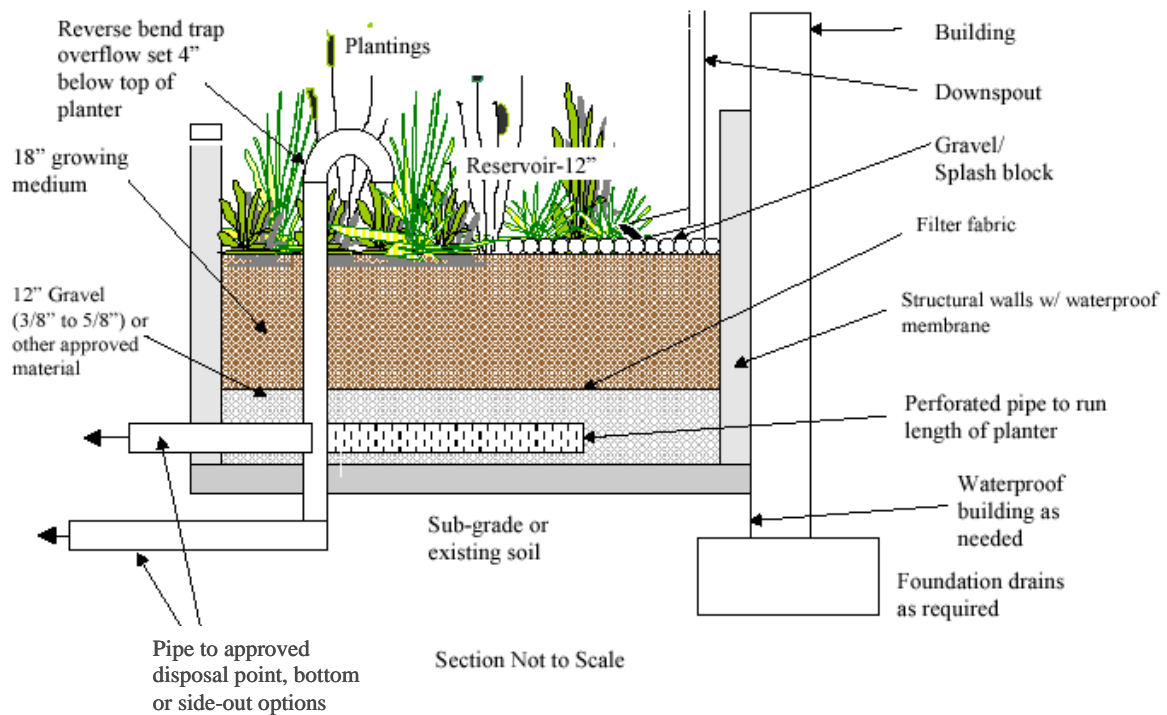

Figure 15.3 Schematic of Flow-Through Planter Box
 (Source: City of Portland, Oregon)

16.0 Sand Filters

General Application
Structural Stormwater Control



Description: Multi-chamber structure designed to treat stormwater runoff through filtration, using a sediment forebay, a sand bed as its primary filter media and, typically, an underdrain collection system.

KEY CONSIDERATIONS

DESIGN CRITERIA:

- Typically requires 2 to 6 feet of head
- Maximum contributing drainage area of 10 acres for surface sand filter; 2 acres for perimeter sand filter
- Sand filter media with underdrain system

ADVANTAGES / BENEFITS:

- Applicable to small drainage areas
- Good for highly impervious areas
- Good retrofit capability

DISADVANTAGES / LIMITATIONS:

- High maintenance burden
- Not recommended for areas with high sediment content in stormwater or clay/silt runoff areas
- Relatively costly
- Possible odor problems

MAINTENANCE REQUIREMENTS:

- Inspect for clogging – rake first inch of sand
- Remove sediment from forebay/chamber
- Replace sand filter media as needed

POLLUTANT REMOVAL

80%	Total Suspended Solids
50/25%	Nutrients - Total Phosphorus / Total Nitrogen removal
50%	Metals - Cadmium, Copper, Lead, and Zinc removal
40%	Pathogens - Coliform, Streptococci, E.Coli removal

STORMWATER MANAGEMENT SUITABILITY

- P** Water Quality Protection
- S** Streambank Protection
- On-Site Flood Control**
- Downstream Flood Control**

Accepts Hotspot Runoff: Yes
(requires impermeable liner)

IMPLEMENTATION CONSIDERATIONS

- L** Land Requirement
- H** Capital Cost
- H** Maintenance Burden

Residential Subdivision Use: No

High Density/Ultra-Urban: Yes

Drainage Area: 2-10 acres max.

Soils: Clay or silty soils may require pretreatment

Other Considerations:

- Typically needs to be combined with other controls to provide water quantity control

L=Low M=Moderate H=High

16.1 General Description

Sand filters (also referred to as *filtration basins*) are structural stormwater controls that capture and temporarily store stormwater runoff and pass it through a filter bed of sand. Most sand filter systems consist of two-chamber structures. The first chamber is a sediment forebay or sedimentation chamber, which removes floatables and heavy sediments. The second is the filtration chamber, which removes additional pollutants by filtering the runoff through a sand bed. The filtered runoff is typically collected and returned to the conveyance system, though it can also be partially or fully infiltrated into the surrounding soil in areas with porous soils.

Because they have few site constraints beside head requirements, sand filters can be used on development sites where the use of other structural controls may be precluded. However, sand filter systems can be relatively expensive to construct, install, and maintain.

There are two primary sand filter system designs, the *surface sand filter* and the *perimeter sand filter*. Below are descriptions of these filter systems:

- **Surface Sand Filter** – The surface sand filter is a ground-level open air structure that consists of a pretreatment sediment forebay and a filter bed chamber. This system can treat drainage areas up to 10 acres in size and is typically located off-line. Surface sand filters can be designed as an excavation with earthen embankments or as a concrete or block structure.
- **Perimeter Sand Filter** – The perimeter sand filter is an enclosed filter system typically constructed just below grade in a vault along the edge of an impervious area such as a parking lot. The system consists of a sedimentation chamber and a sand bed filter. Runoff flows into the structure through a series of inlet grates located along the top of the control.

A third design variant, the *underground sand filter*, is intended primarily for extremely space limited and high density areas and is thus considered a limited application structural control. See [Section 16.0](#) on Underground Sand Filters for more details.

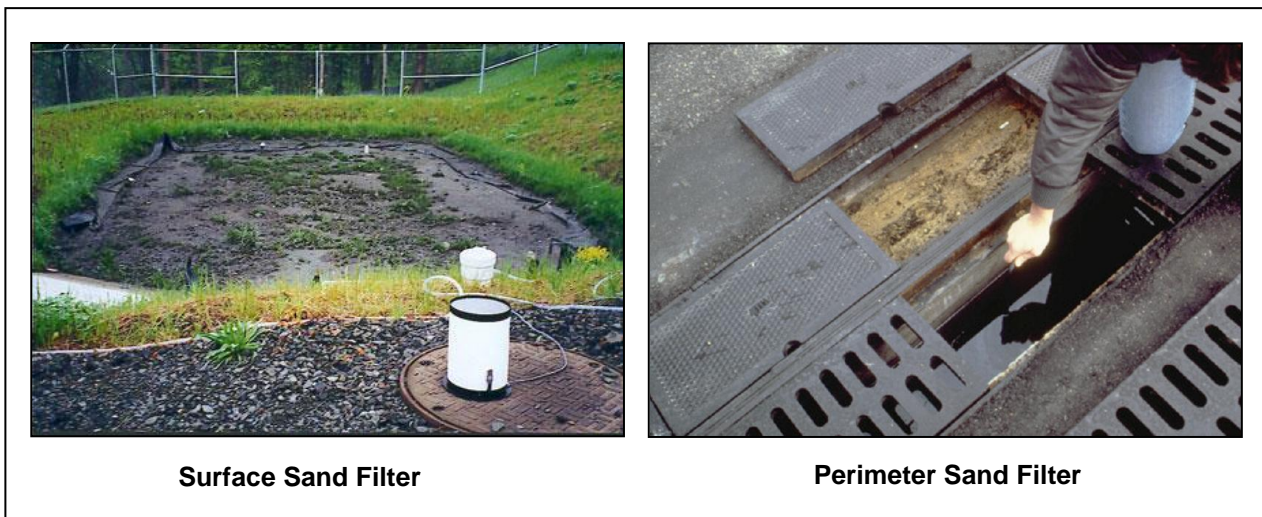

Surface Sand Filter

Perimeter Sand Filter

Figure 16.1 Sand Filter Examples

16.2 Stormwater Management Suitability

Sand filter systems are designed primarily as off-line systems for stormwater quality (i.e., the removal of stormwater pollutants) and will typically need to be used in conjunction with another structural control to provide downstream streambank protection, on-site flood control, and downstream flood control, if required. However, under certain circumstances, filters can provide limited runoff quantity control, particularly for smaller storm events.

Water Quality

In sand filter systems, stormwater pollutants are removed through a combination of gravitational settling, filtration, and adsorption. The filtration process effectively removes suspended solids and particulates, biochemical oxygen demand (BOD), fecal coliform bacteria, and other pollutants. Surface sand filters with a grass cover have additional opportunities for bacterial decomposition as well as vegetation uptake of pollutants, particularly nutrients. [Section 16.3](#) provides pollutant removal efficiencies that can be used for planning and design purposes.

Streambank Protection

For smaller sites, a sand filter may be designed to capture the entire streambank protection volume SP_v in either an off- or on-line configuration. Given that a sand filter system is typically designed to completely drain over 40 hours, the requirement of extended detention of the 1-year, 24-hour storm runoff volume will be met. For larger sites or where only the WQ_v is diverted to the sand filter facility, another structural control must be used to provide SP_v extended detention.

On-Site Flood Control

Another structural control must be used in conjunction with a sand filter system to reduce the post-development peak flow to pre-development levels (detention) if needed.

Downstream Flood Control

Sand filter facilities must provide flow diversion and/or be designed to safely pass extreme storm flows and protect the filter bed and facility.

The volume of runoff removed and treated by the sand filter may be taken in the on-site flood control and downstream flood control calculations (see [Section 1.0](#)).

16.3 Pollutant Removal Capabilities

Both the surface and perimeter sand filters are presumed to be able to remove 80% of the total suspended solids load in typical urban post-development runoff when sized, designed, constructed and maintained in accordance with the recommended specifications. Undersized or poorly designed sand filters can reduce TSS removal performance.

The following design pollutant removal rates are conservative average pollutant reduction percentages for design purposes derived from sampling data, modeling, and professional judgment. In a situation where a removal rate is not deemed sufficient, additional controls may be put in place at the given site in a series or “treatment train” approach.

- Total Suspended Solids – 80%
- Total Phosphorus – 50%
- Total Nitrogen – 25%
- Fecal Coliform – 40%
- Heavy Metals – 50%

For additional information and data on pollutant removal capabilities for sand filters, see the National Pollutant Removal Performance Database (2nd Edition) available at www.cwp.org and the National Stormwater Best Management Practices (BMP) Database at www.bmpdatabase.org

16.4 Application and Site Feasibility Criteria

Sand filter systems are well suited for highly impervious areas where land available for structural controls is limited. Sand filters should primarily be considered for new construction or retrofit opportunities for commercial, industrial, and institutional areas where the sediment load is relatively low, such as: parking lots, driveways, loading docks, gas stations, garages, airport runways/taxiways, and storage yards. Sand filters may also be feasible and appropriate in some multi-family or higher density residential developments.

To avoid rapid clogging and failure of the filter media, the use of sand filters should be avoided in areas with less than 50% impervious cover, or high sediment yield sites with clay/silt soils.

The following basic criteria should be evaluated to ensure the suitability of a sand filter facility for meeting stormwater management objectives on a site or development.

General Feasibility

- Suitable for Residential Subdivision Usage – NO
- Suitable for High Density/Ultra Urban Areas – YES
- Regional Stormwater Control – NO

Physical Feasibility - Physical Constraints at Project Site

- Drainage Area – 10 acres maximum for surface sand filter; 2 acres maximum for perimeter sand filter
- Space Required – Function of available head at site
- Site Slope – No more than 6% slope across filter location
- Minimum Head – Elevation difference needed at a site from the inflow to the outflow: 5 feet for surface sand filters; 2 to 3 feet for perimeter sand filters
- Minimum Depth to Water Table – For a surface sand filter with infiltration (earthen structure), 2 feet are required between the bottom of the sand filter and the elevation of the seasonally high water table
- Soils – No restrictions; Group “A” soils generally required to allow infiltration (for surface sand filter earthen structure)
- Downstream Water Surface - Downstream flood conditions need to be verified to avoid surcharging and back washing of the filter material.

Other Constraints / Considerations

- Aquifer Protection – Do not allow infiltration of filtered hotspot runoff into groundwater

16.5 Planning and Design Criteria

*The following criteria are to be considered **minimum** standards for the design of a sand filter facility. Consult with the local review authority to determine if there are any variations to these criteria or additional standards that must be followed.*

A. Location and Siting

Surface sand filters should have a contributing drainage area of 10 acres or less. The maximum drainage area for a perimeter sand filter is 2 acres.

Sand filter systems are generally applied to land uses with a high percentage of impervious surfaces. Sites with less than 50% imperviousness or high clay/silt sediment loads must not use a sand filter without adequate pretreatment due to potential clogging and failure of the filter bed. Any disturbed areas

within the sand filter facility drainage area should be identified and stabilized. Filtration controls should only be constructed after the construction site is stabilized.

Surface sand filters are generally used in an off-line configuration where the water quality volume (WQ_v) is diverted to the filter facility through the use of a flow diversion structure and flow splitter. Stormwater flows greater than the WQ_v are diverted to other controls or downstream using a diversion structure or flow splitter.

Perimeter sand filters are typically sited along the edge, or perimeter, of an impervious area such as a parking lot.

Sand filter systems are designed for intermittent flow and must be allowed to drain and reaerate between rainfall events. They should not be used on sites with a continuous flow from groundwater, sump pumps, or other sources.

B. General Design

Surface Sand Filter

A surface sand filter facility consists of a two-chamber open-air structure, which is located at ground-level. The first chamber is the sediment forebay (a.k.a sedimentation chamber) while the second chamber houses the sand filter bed. Flow enters the sedimentation chamber where settling of larger sediment particles occurs. Runoff is then discharged from the sedimentation chamber through a perforated standpipe into the filtration chamber. After passing through the filter bed, runoff is collected by a perforated pipe and gravel underdrain system. Figure 16.6 provides plan view and profile schematics of a surface sand filter.

Perimeter Sand Filter

A perimeter sand filter facility is a vault structure located just below grade level. Runoff enters the device through inlet grates along the top of the structure into the sedimentation chamber. Runoff is discharged from the sedimentation chamber through a weir into the filtration chamber. After passing through the filter bed, runoff is collected by a perforated pipe and gravel underdrain system. Figure 16.7 provides plan view and profile schematics of a perimeter sand filter.

C. Physical Specifications / Geometry

Surface Sand Filter

The entire treatment system (including the sedimentation chamber) must temporarily hold at least 75% of the WQ_v prior to filtration. Figure 16.2 illustrates the distribution of the treatment volume ($0.75 WQ_v$) among the various components of the surface sand filter, including:

- V_s – volume within the sedimentation basin
- V_f – volume within the voids in the filter bed
- V_{f-temp} – temporary volume stored above the filter bed
- A_s – the surface area of the sedimentation basin
- A_f – surface area of the filter media
- h_s – height of water in the sedimentation basin
- h_{temp} - depth of temporary volume
- h_f – average height of water above the filter media ($1/2 h_{temp}$)
- d_f – depth of filter media

The sedimentation chamber must be sized to at least 25% of the computed WQ_v and have a length-to-width ratio of at least 2:1. Inlet and outlet structures should be located at opposite ends of the chamber.

The filter area is sized based on the principles of Darcy's Law. A coefficient of permeability (k) of 3.5 ft/day for sand should be used. The filter bed is typically designed to completely drain in 40 hours or less.

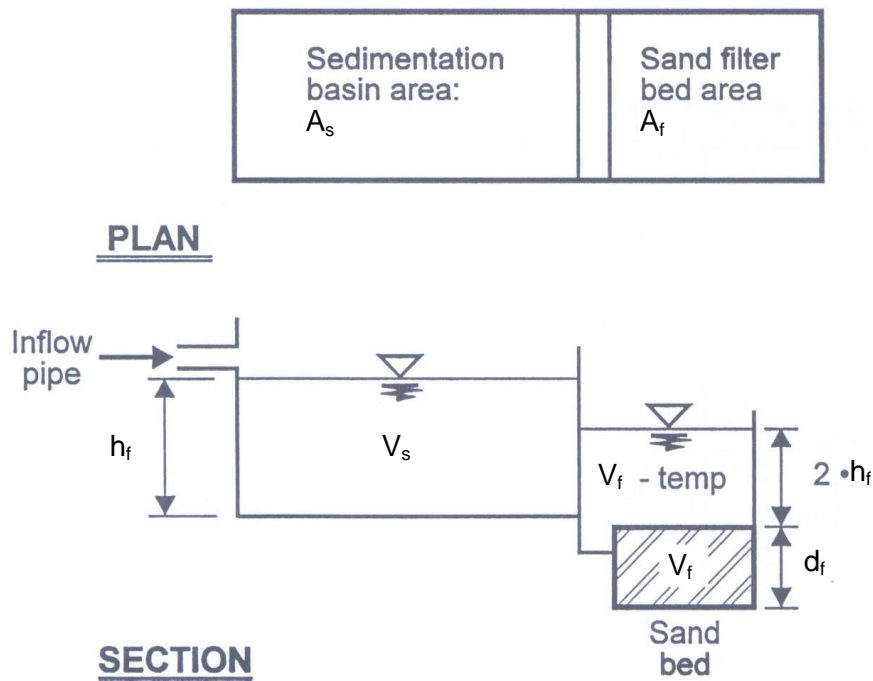

Figure 16.2 Surface Sand Filter Volumes

Source: Claytor and Schueler, 1996

The filter media consists of an 18-inch layer of clean washed medium sand (meeting ASTM C-33 concrete sand or TxDOT Fine Aggregate Grade No. 1) on top of the underdrain system. Three inches of topsoil are placed over the sand bed. Permeable filter fabric is placed both above and below the sand bed to prevent clogging of the sand filter and the underdrain system. A proper fabric selection is critical. Choose a filter fabric with equivalent pore openings as to prevent clogging by sandy filler material. Figure 16.4 illustrates a typical media cross section.

The filter bed is equipped with a 6-inch perforated PVC pipe (AASHTO M 252) underdrain in a gravel layer. The underdrain must have a minimum grade of 1/8-inch per foot (1% slope). Holes should be 3/8-inch diameter and spaced approximately 6 inches on center. Gravel should be clean washed aggregate with a maximum diameter of 3.5 inches and a minimum diameter of 1.5 inches with a void space of about 40% meeting the gradation listed below. Aggregate contaminated with soil shall not be used.

<u>Sieve Size</u>	<u>Gradation</u>	<u>% Passing</u>
2 1/2"		100
2"		90 – 100
1 1/2"		35 – 70
1"		0 – 15
1/2"		0 - 5

The structure of the surface sand filter may be constructed of impermeable media such as concrete, or through the use of excavations and earthen embankments. When constructed with earthen walls/embankments, filter fabric should be used to line the bottom and side slopes of the structures before installation of the underdrain system and filter media.

Perimeter Sand Filter

The entire treatment system (including the sedimentation chamber) must temporarily hold at least 75% of the WQ_v prior to filtration. Figure 16.3 illustrates the distribution of the treatment volume ($0.75 WQ_v$) among the various components of the perimeter sand filter, including:

- V_w – wet pool volume within the sedimentation basin
- V_f – volume within the voids in the filter bed
- V_{temp} – temporary volume stored above the filter bed
- A_s – the surface area of the sedimentation basin
- A_f – surface area of the filter media
- h_f – average height of water above the filter media ($1/2 h_{temp}$)
- h_{temp} - depth of temporary volume
- d_f – depth of filter media

The sedimentation chamber must be sized to at least 50% of the computed WQ_v .

The filter area is sized based on the principles of Darcy's Law. A coefficient of permeability (k) of 3.5 ft/day for sand should be used. The filter bed is typically designed to completely drain in 40 hours or less.

The filter media should consist of a 12- to 18-inch layer of clean washed medium sand (meeting ASTM C-33 concrete sand or TxDOT Fine Aggregate Grade No. 1) on top of the underdrain system. Figure 16.4 illustrates a typical media cross section.

The perimeter sand filter is equipped with a 4 inch perforated PVC pipe (AASHTO M 252) underdrain in a gravel layer. The underdrain must have a minimum grade of 1/8 inch per foot (1% slope). Holes should be 3/8-inch diameter and spaced approximately 6 inches on center. A permeable filter fabric should be placed between the gravel layer and the filter media. Gravel should be clean washed aggregate with a maximum diameter of 3.5 inches and a minimum diameter of 1.5 inches with a void space of about 40% meeting the following gradation. Aggregate contaminated with soil shall not be used.

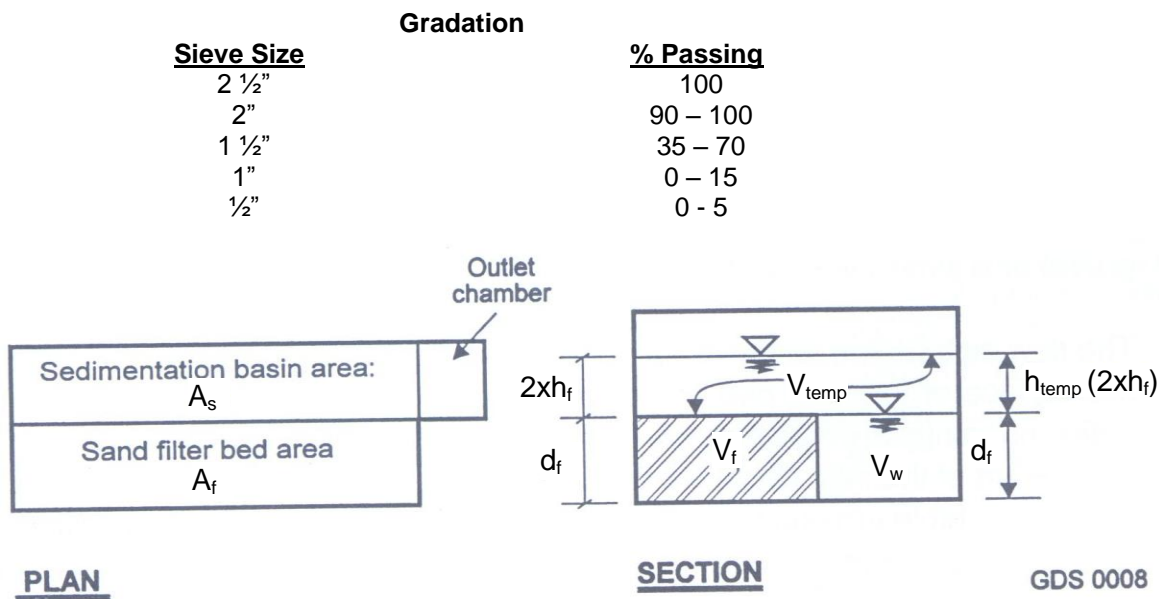

Figure 16.3 Perimeter Sand Filter Volumes

(Source: Clayton and Schueler, 1996)

D. Pretreatment / Inlets

Pretreatment of runoff in a sand filter system is provided by the sedimentation chamber.

Inlets to surface sand filters are to be provided with energy dissipaters. Exit velocities from the sedimentation chamber must be nonerosive.

Figure 16.5 shows a typical inlet pipe from the sedimentation basin to the filter media basin for the surface sand filter.

E. Outlet Structures

Outlet pipe is to be provided from the underdrain system to the facility discharge. Due to the slow rate of filtration, outlet protection is generally unnecessary (except for emergency overflows and spillways).

F. Emergency Spillway

An emergency or bypass spillway must be included in the surface sand filter to safely pass flows that exceed the design storm flows. The spillway prevents filter water levels from overtopping the embankment and causing structural damage. The emergency spillway should be located so that downstream buildings and structures will not be impacted by spillway discharges.

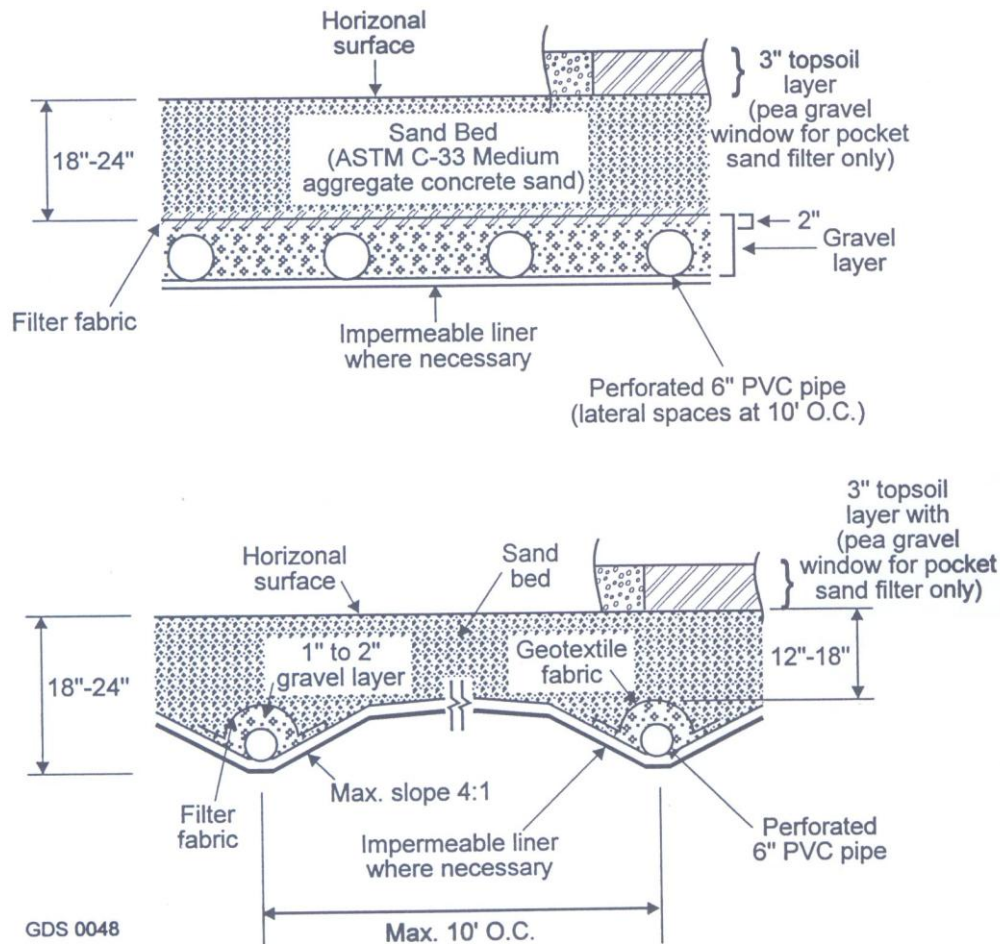

Figure 16.4 Typical Sand Filter Media Cross Sections

(Source: Claytor and Schueler, 1996)

G. Maintenance Access

Adequate access must be provided for all sand filter systems for inspection and maintenance, including the appropriate equipment and vehicles. Access grates to the filter bed need to be included in a perimeter sand filter design. Facility designs must enable maintenance personnel to easily replace upper layers of the filter media.

H. Safety Features

Surface sand filter facilities can be fenced to prevent access. Inlet and access grates to perimeter sand filters may be locked.

I. Landscaping

Surface filters can be designed with a grass cover to aid in pollutant removal and prevent clogging. The grass should be capable of withstanding frequent periods of inundation and drought.

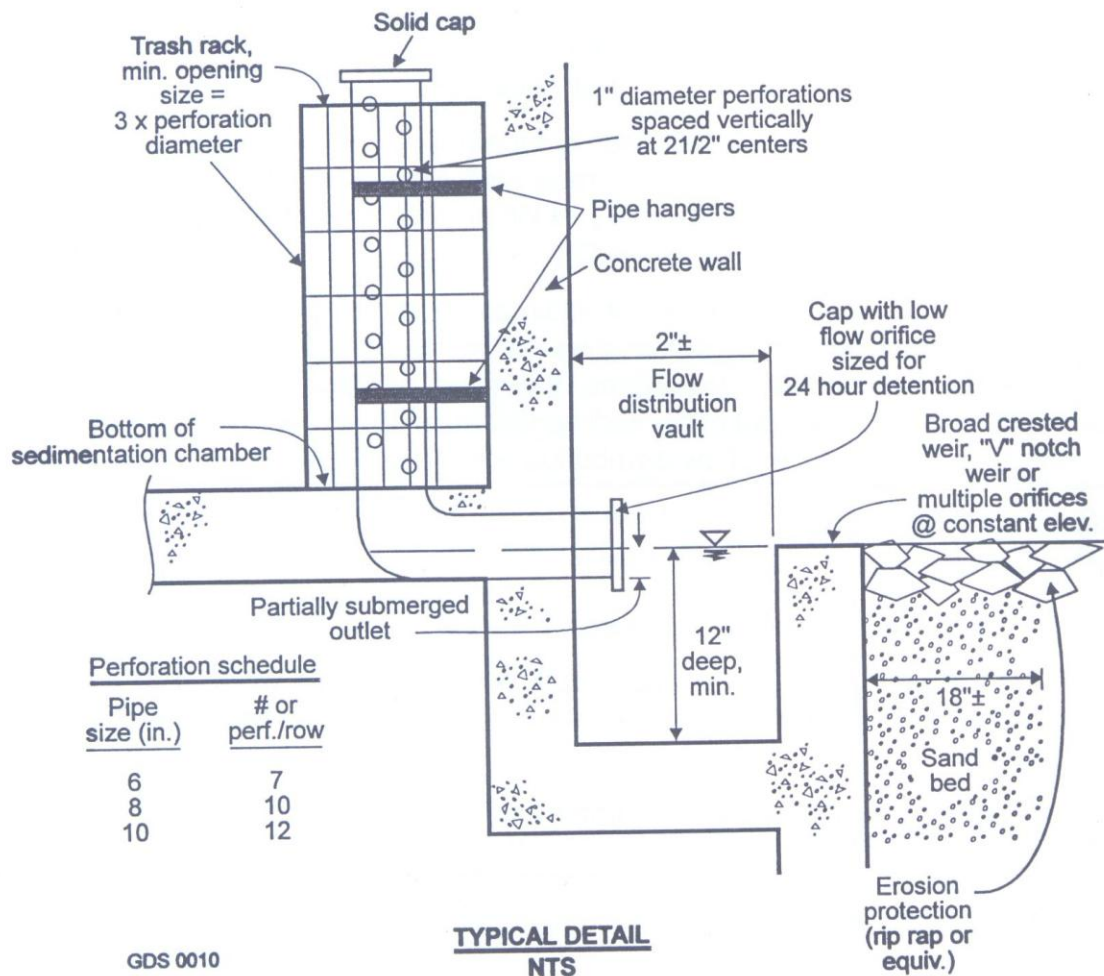

Figure 16.5 Surface Sand Filter Perforated Stand-Pipe

(Source: Claytor and Schueler, 1996)

J Additional Site-Specific Design Criteria and Issues

Physiographic Factors - Local terrain design constraints

- Low Relief – Use of surface sand filter may be limited by low head
- High Relief – Filter bed surface must be level
- Karst – Use polyliner or impermeable membrane to seal bottom of earthen surface sand filter or use watertight structure

Soils

- No restrictions

Special Downstream Watershed Considerations

- Stream Warming – Consideration should be given to the thermal influence on potential fish habitats downstream. If stream warming is significant, use shorter drain time (24 hours)
- Aquifer Protection – Use polyliner or impermeable membrane to seal bottom of earthen surface sand filter or use watertight structure; no infiltration of filter runoff into groundwater

16.6 Design Procedures

Step 1 Compute runoff control volumes from the *integrated* Design Focus Areas

Calculate the Water Quality Volume (WQ_v), Streambank Protection Volume (SP_v), On-Site Flood Control Volume (Q_p), and the Downstream Flood Control Volume (V_t).

Details on the *integrated* Design Focus Areas are found in [Section 1.0 of the Planning Technical Manual](#).

Step 2 Determine if the development site and conditions are appropriate for the use of a surface or perimeter sand filter.

Consider the Application and Site Feasibility Criteria in [Sections 16.4 and 16.5 \(A\)](#) (Location and Siting).

Step 3 Confirm local design criteria and applicability

Consider any special site-specific design conditions/criteria from [Section 16.5 \(J\)](#) (Additional Site-Specific Design Criteria and Issues).

Check with local officials and other agencies to determine if there are any additional restrictions and/or surface water or watershed requirements that may apply.

Step 4 Compute WQ_v peak discharge (Q_{wq})

The peak rate of discharge for water quality design storm is needed for sizing of off-line diversion structures (see [Section 1.0 of the Water Quality Technical Manual](#)).

- Using WQ_v , compute CN
- Compute time of concentration using TR-55 method
- Determine appropriate unit peak discharge from time of concentration
- Compute Q_{wq} from unit peak discharge, drainage area, and WQ_v .

Step 5 Size flow diversion structure, if needed

A flow regulator (or flow splitter diversion structure) should be supplied to divert the WQ_v to the sand filter facility.

Size low flow orifice, weir, or other device to pass Q_{wq} .

Step 6 Size filtration basin chamber

The filter area is sized using the following equation (based on Darcy's Law, Equation 2.1):

$$A_f = (WQ_v) (d_f) / [(k) (h_f + d_f) (t_f)]$$

where:

- A_f = surface area of filter bed (ft²)
- d_f = filter bed depth
(typically 18 inches, no more than 24 inches)
- k = coefficient of permeability of filter media (ft/day)
(use 3.5 ft/day for sand)
- h_f = average height of water above filter bed (ft)
(1/2 h_{max} , which varies based on site but h_{max} is typically ≤ 6 feet)
- t_f = design filter bed drain time (days)
(1.67 days or 40 hours is recommended maximum)

Set preliminary dimensions of filtration basin chamber.

See [Section 16.5 \(C\)](#) (Physical Specifications/Geometry) for filter media specifications.

Step 7 Size sedimentation chamber

Surface sand filter: The sedimentation chamber should be sized to at least 25% of the computed WQ_v and have a length-to-width ratio of 2:1. The Camp-Hazen equation is used to compute the required surface area:

$$A_s = - (Q_o/w) * \ln (1-E) \quad (16.1)$$

where:

- A_s = sedimentation basin surface area (ft²)
- Q_o = rate of outflow = the WQ_v over a 24-hour period
- w = particle settling velocity (ft/sec)
- E = trap efficiency

Assuming:

- 90% sediment trap efficiency (0.9)
- particle settling velocity (ft/sec) = 0.0033 ft/sec for imperviousness < 75%
- particle settling velocity (ft/sec) = 0.0004 ft/sec for imperviousness $\geq 75\%$
- average of 24 hour holding period

Then:

$$A_s = (0.066) (WQ_v) \text{ ft}^2 \text{ for } I < 75\%$$

$$A_s = (0.0081) (WQ_v) \text{ ft}^2 \text{ for } I \geq 75\%$$

Set preliminary dimensions of sedimentation chamber.

Perimeter sand filter: The sedimentation chamber should be sized to at least 50% of the computed WQ_v . Use same approach as for surface sand filter.

Step 8 Compute V_{min}

$$V_{min} = 0.75 * WQ_v$$

Step 9 Compute storage volumes within entire facility and sedimentation chamber orifice size

Surface sand filter:

$$V_{min} = 0.75 WQ_v = V_s + V_f + V_{f-temp} \quad (16.2)$$

- (1) Compute V_f = water volume within filter bed/gravel/pipe = $A_f * d_f * n$
where: n = porosity = 0.4 for most applications
- (2) Compute V_{f-temp} = temporary storage volume above the filter bed = $2 * h_f * A_f$
- (3) Compute V_s = volume within sediment chamber = $V_{min} - V_f - V_{f-temp}$

- (4) Compute h_s = height in sedimentation chamber = V_s/A_s
- (5) Ensure h_s and h_f fit available head and other dimensions still fit – change as necessary in design iterations until all site dimensions fit.
- (6) Size orifice from sediment chamber to filter chamber to release V_s within 24-hours at average release rate with $0.5 h_s$ as average head.
- (7) Design outlet structure with perforations allowing for a safety factor of 10 (see example)
- (8) Size distribution chamber to spread flow over filtration media – level spreader weir or orifices.

Perimeter sand filter:

- (1) Compute V_f = water volume within filter bed/gravel/pipe = $A_f * d_f * n$
where: n = porosity = 0.4 for most applications
- (2) Compute V_w = wet pool storage volume $A_s * 2$ feet minimum
- (3) Compute V_{temp} = temporary storage volume = $V_{min} - (V_f + V_w)$
- (4) Compute h_{temp} = temporary storage height = $V_{temp} / (A_f + A_s)$
- (5) Ensure $h_{temp} \geq 2 * h_f$, otherwise decrease h_f and re-compute. Ensure dimensions fit available head and area – change as necessary in design iterations until all site dimensions fit.
- (6) Size distribution slots from sediment chamber to filter chamber.

Step 10 Design inlets, pretreatment facilities, underdrain system, and outlet structures

See [Section 16.5](#) (D) through (H) for more details.

Step 11 Compute overflow weir sizes

Surface sand filter:

- (1) Size overflow weir at elevation h_s in sedimentation chamber (above perforated stand pipe) to handle surcharge of flow through filter system from storms producing more than 1.5 inches (see example in [Section 29.3](#)).
- (2) Plan inlet protection for overflow from sedimentation chamber and size overflow weir at elevation h_f in filtration chamber (above perforated stand pipe) to handle surcharge of flow through filter system from storms producing more than 1.5 inches (see example).

Perimeter sand filter: Size overflow weir at end of sedimentation chamber to handle excess inflow, set at WQ_v elevation.

See [Section 29.3](#) for a Sand Filter Design Example

16.7 Inspection and Maintenance Requirements

Table 16.1 Typical Maintenance Activities for Sand Filters

(Source: WMI, 1997; Pitt, 1997)

Activity	Schedule
<ul style="list-style-type: none"> • Ensure that contributing area, facility, inlets, and outlets are clear of debris. • Ensure that the contributing area is stabilized and mowed, with clippings removed. • Remove trash and debris. • Check to ensure that the filter surface is not clogging (also check after moderate and major storms). • Ensure that activities in the drainage area minimize oil/grease and sediment entry to the system. • If permanent water level is present (perimeter sand filter), ensure that the chamber does not leak and normal pool level is retained. 	Monthly
<ul style="list-style-type: none"> • Check to see that the filter bed is clean of sediment, and the sediment chamber is not more than 50% full or 6 inches, whichever is less, of sediment. Remove sediment as necessary. • Stabilize disturbed area contributing to the heavy sediment load. • Make sure that there is no evidence of deterioration, spalling, or cracking of concrete. • Inspect grates (perimeter sand filter). • Inspect inlets, outlets, and overflow spillway to ensure good condition and no evidence of erosion. • Repair or replace any damaged structural parts. • Stabilize any eroded areas. • Ensure that flow is not bypassing the facility. • Ensure that no noticeable odors are detected outside the facility. 	Annually
<ul style="list-style-type: none"> • If filter bed is clogged or partially clogged, manual manipulation of the surface layer of sand may be required. Remove the top few inches of sand, roto-till or otherwise cultivate the surface, and replace media with sand meeting the design specifications. • Replace any filter fabric that has become clogged. 	As needed

Additional Maintenance Considerations and Requirements

- A record should be kept of the dewatering time for a sand filter to determine if maintenance is necessary.
- When the filtering capacity of the sand filter facility diminishes substantially (i.e., when water ponds on the surface of the filter bed for more than 48 hours), then the top layers of the filter media (topsoil and 2 to 3 inches of sand) will need to be removed and replaced. This will typically need to be done every 3 to 5 years for low sediment applications, more often for areas of high sediment yield or high oil and grease.
- Removed sediment and media may usually be disposed of in a landfill.



Regular inspection and maintenance is critical to the effective operation of sand filter facilities as designed. Maintenance responsibility for a sand filter system should be vested with a responsible authority by means of a legally binding and enforceable maintenance agreement that is executed as a condition of plan approval.

16.8 Example Schematics

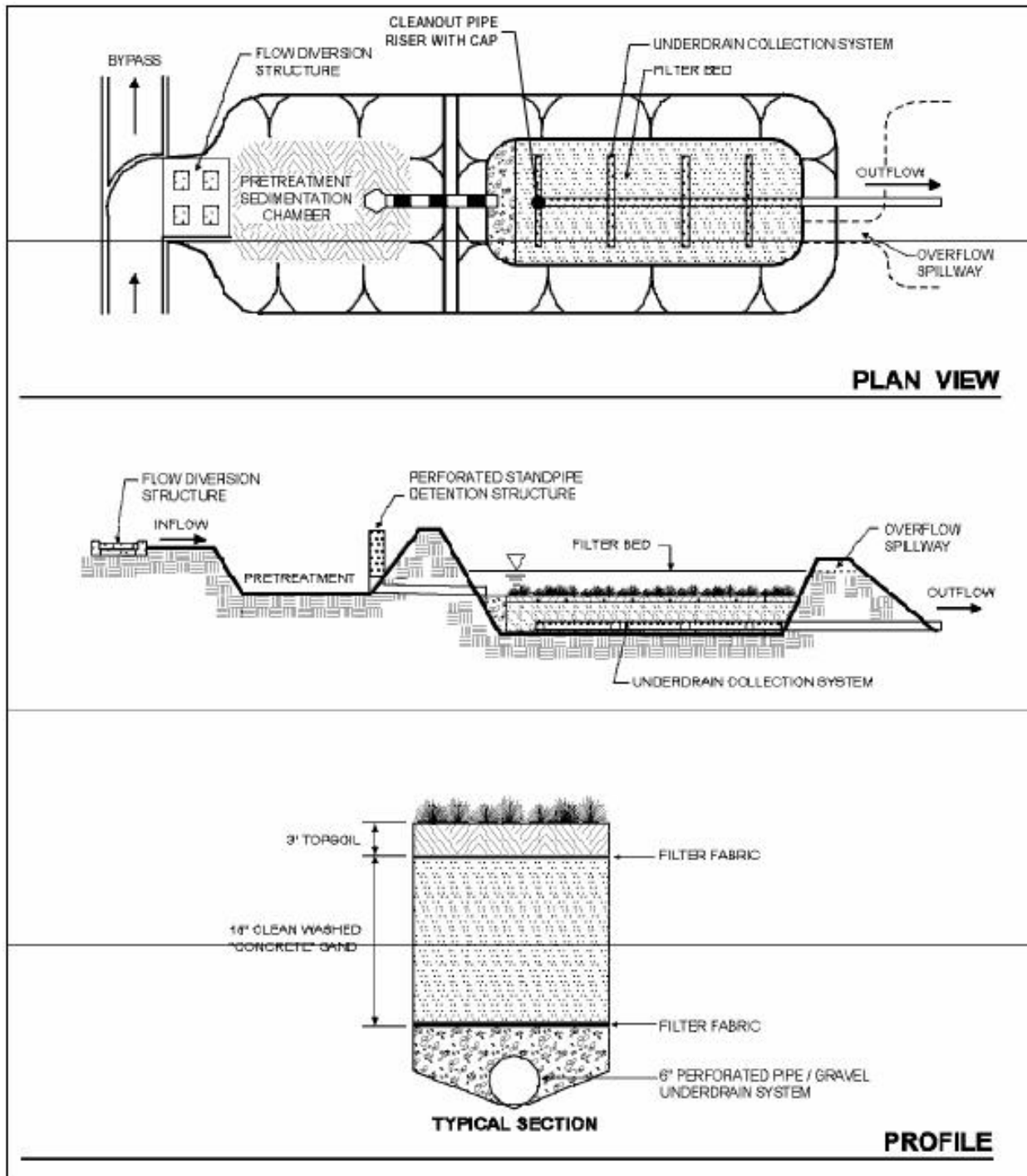

Figure 16.6 Schematic of Surface Sand Filter

(Source: Center for Watershed Protection)

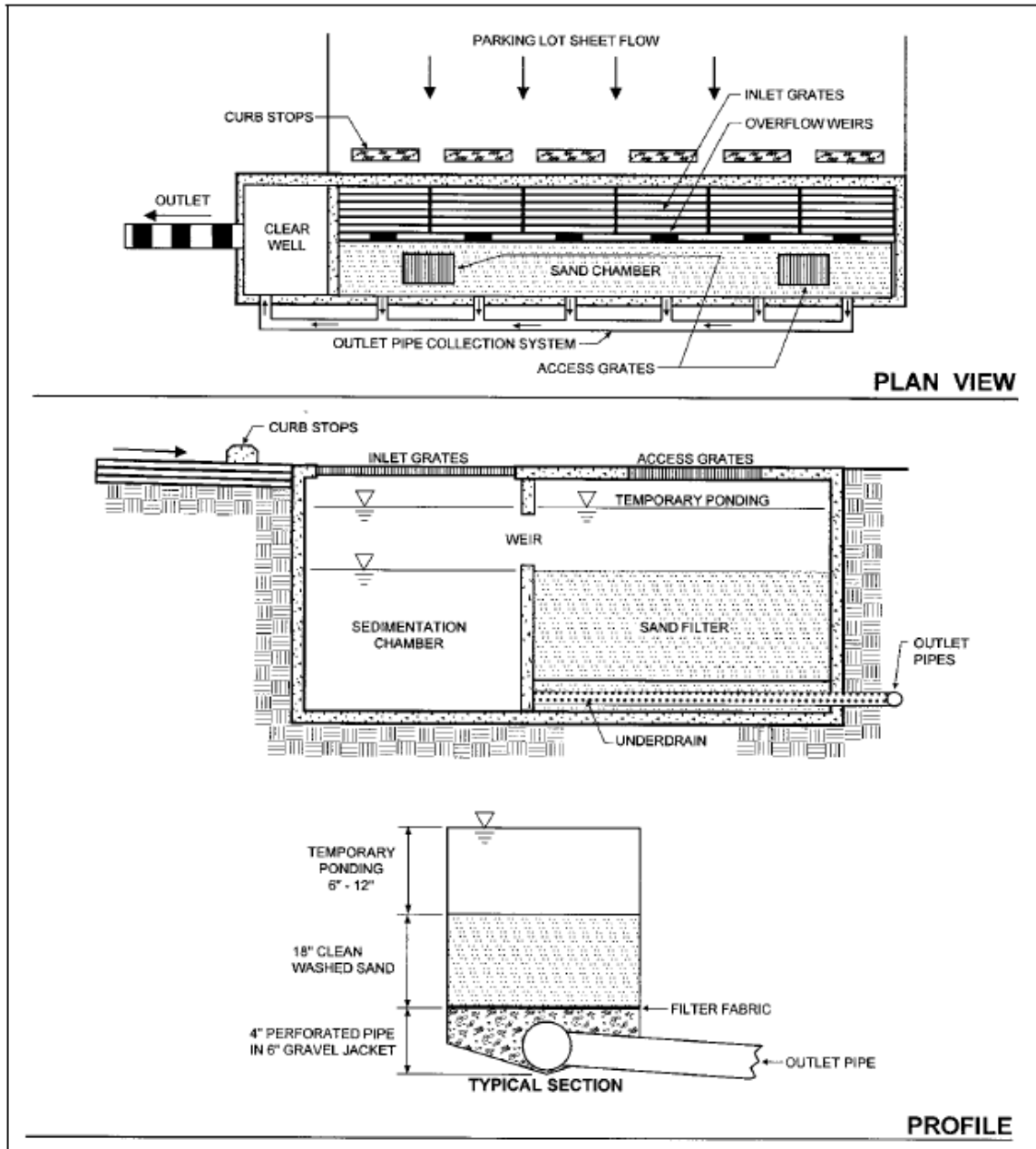

Figure 16.7 Schematic of Perimeter Sand Filter
 (Source: Center for Watershed Protection)

16.9 Design Forms

Design Procedure Form: Sand Filters

PRELIMINARY HYDROLOGIC

- 1a. Compute WQ_v volume requirements
 Compute Runoff Coefficient, R_v
 Compute WQ_v
- 1b. Compute SP_v
 Compute average release rate
 Compute Q_p (100-year detention volume required)
 Compute (as necessary) Q_t

$$R_v = \underline{\hspace{2cm}}$$

$$WQ_v = \underline{\hspace{2cm}} \text{ acre-ft}$$

$$SP_v = \underline{\hspace{2cm}} \text{ acre-ft}$$

$$\text{release rate} = \underline{\hspace{2cm}} \text{ cfs}$$

$$Q_p = \underline{\hspace{2cm}} \text{ acre-ft}$$

$$Q_t = \underline{\hspace{2cm}} \text{ cfs}$$

SAND FILTER DESIGN

- 2. Is the use of a sand filter appropriate?

- 3. Confirm local design criteria and applicability.
- 4. Compute WQ_v peak discharge (Q_{vq})
 Compute Curve Number
 Compute Time of Concentration t_c
 Compute Q_{wq}
- 5. Size flow diversion structure
 Low flow orifice - Orifice equation

 Overflow weir - Weir equation
- 6. Size filtration bed chamber
 Compute area from Darcy's Law
 Using length to width (2:1) ratio
- 7. Size sedimentation chamber
 Compute area from Camp-Hazen equation
 Given W from step 5, compute Length
- 8. Compute V_{min}
- 9. Compute volume within practice

$$\text{Low Point in development area} = \underline{\hspace{2cm}}$$

$$\text{Low Point at stream invert} = \underline{\hspace{2cm}}$$

$$\text{Total available head} = \underline{\hspace{2cm}}$$

$$\text{Average depth, } h_r = \underline{\hspace{2cm}}$$

See subsections 5.2.15.4 and 5.2.15.5-A

See subsection 5.2.15.5-J

$$CN = \underline{\hspace{2cm}}$$

$$t_c = \underline{\hspace{2cm}} \text{ hour}$$

$$Q_{wq} = \underline{\hspace{2cm}} \text{ cfs}$$

$$A = \underline{\hspace{2cm}} \text{ ft}^2$$

$$\text{diameter} = \underline{\hspace{2cm}} \text{ in}$$

$$\text{Length} = \underline{\hspace{2cm}} \text{ ft}$$

$$A_f = \underline{\hspace{2cm}} \text{ ft}^2$$

$$L = \underline{\hspace{2cm}} \text{ ft}$$

$$W = \underline{\hspace{2cm}} \text{ ft}$$

$$A_f = \underline{\hspace{2cm}} \text{ ft}^2$$

$$L = \underline{\hspace{2cm}} \text{ ft}$$

$$V_{min} = \underline{\hspace{2cm}} \text{ ft}^3$$

Surface sand filter

- Volume within filter bed
- Temporary storage above filter bed
- Sedimentation chamber (remaining volume)
- Height in sedimentation chamber
- Perforated stand pipe - Orifice equation

$$V_f = \underline{\hspace{2cm}} \text{ ft}^3$$

$$V_{s-temp} = \underline{\hspace{2cm}} \text{ ft}^3$$

$$V_s = \underline{\hspace{2cm}} \text{ ft}^3$$

$$h_s = \underline{\hspace{2cm}} \text{ ft}$$

$$A = \underline{\hspace{2cm}} \text{ ft}^2$$

$$\text{diameter} = \underline{\hspace{2cm}} \text{ in}$$

Perimeter sand filter

- Compute volume in filter bed
- Compute wet pool storage
- Compute temporary storage

$$V_f = \underline{\hspace{2cm}} \text{ ft}^3$$

$$V_w = \underline{\hspace{2cm}} \text{ ft}^3$$

$$V_{temp} = \underline{\hspace{2cm}} \text{ ft}^3$$

$$h_{temp} = \underline{\hspace{2cm}} \text{ ft}$$

- 10. Compute overflow weir sizes
 Compute overflow - Orifice equation
 Weir from sedimentation chamber - Weir equation
 Weir from filtration chamber - Weir equation

$$Q = \underline{\hspace{2cm}} \text{ cfs}$$

$$\text{Length} = \underline{\hspace{2cm}} \text{ ft}$$

$$\text{Length} = \underline{\hspace{2cm}} \text{ ft}$$

Notes:

17.0 Underground Sand Filter

Limited Application
Structural Stormwater Control

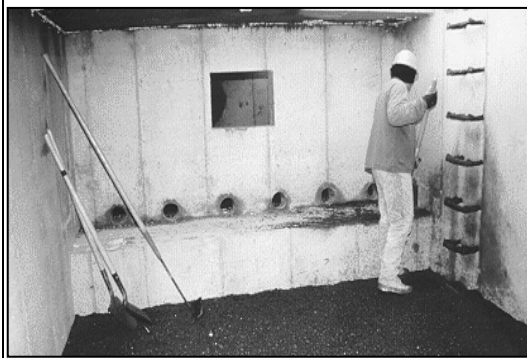

Description: Design variant of the sand filter located in an underground vault.

KEY CONSIDERATIONS

DESIGN CRITERIA:

- Intended for space-limited applications

ADVANTAGES / BENEFITS:

- High pollutant removal capability
- High removal rates for sediment, BOD, and fecal coliform bacteria
- Precast concrete shells available, which decrease construction costs

DISADVANTAGES / LIMITATIONS:

- High maintenance requirements

MAINTENANCE REQUIREMENTS:

- Filter may require more frequent maintenance than most of the other stormwater controls

STORMWATER MANAGEMENT SUITABILITY

- P** Water Quality Protection
- Streambank Protection
- On-Site Flood Control
- Downstream Flood Control

IMPLEMENTATION CONSIDERATIONS

- L** Land Requirement
- H** Capital Cost
- H** Maintenance Burden

Residential Subdivision Use: No

High Density/Ultra-Urban: Yes

Drainage Area: 5 acres max.

Soils: No restrictions

Other Considerations:

- *Hotspot areas*

L=Low M=Moderate H=High

POLLUTANT REMOVAL

- 80%** **Total Suspended Solids**
- 50/25%** **Nutrients** - Total Phosphorus / Total Nitrogen removal
- 50%** **Metals** - Cadmium, Copper, Lead, and Zinc removal
- 40%** **Pathogens** - Coliform, Streptococci, E.Coli removal

17.1 General Description

The underground sand filter is a design variant of the sand filter located in an underground vault designed for high-density land use or ultra-urban applications where there is not enough space for a surface sand filter or other structural stormwater controls.

The underground sand filter is a three-chamber system. The initial chamber is a sedimentation (pretreatment) chamber that temporarily stores runoff and utilizes a wet pool to capture sediment. The sedimentation chamber is connected to the sand filter chamber by a submerged wall that protects the filter bed from oil and trash. The filter bed is 18 to 24 inches deep and may have a protective screen of gravel or permeable geotextile to limit clogging. The sand filter chamber also includes an underdrain system with inspection and clean out wells. Perforated drain pipes under the sand filter bed extend into a third chamber that collects filtered runoff. Flows beyond the filter capacity are diverted through an overflow weir.

Due to its location below the surface, underground sand filters have a high maintenance burden and should only be used where adequate inspection and maintenance can be ensured.

17.2 Pollutant Removal Capabilities

Underground sand filter pollutant removal rates are similar to those for surface and perimeter sand filters (see [Section 16.0](#)).

17.3 Design Criteria and Specifications

- Underground sand filters are typically used on highly impervious sites of 1 acre or less. The maximum drainage area that should be treated by an underground sand filter is 5 acres.
- Underground sand filters are typically constructed on-line, but can be constructed off-line. For off-line construction, the overflow between the second and third chambers is not included.
- The underground vault should be tested for water tightness prior to placement of filter layers.
- Adequate maintenance access must be provided to the sedimentation and filter bed chambers.
- Compute the minimum wet pool volume required in the sedimentation chamber as:

$$V_w = A_s * 3 \text{ feet minimum} \quad (17.1)$$

- Consult the design criteria for the perimeter sand filter (see [Section 16.0](#)) for the rest of the underground filter sizing and design steps.

17.4 Inspection and Maintenance Requirements

Activity	Schedule
Monitor water level in sand filter chamber.	Quarterly and following large storm events
Sedimentation chamber should be cleaned out when the sediment depth reaches 12 inches.	As needed
Remove accumulated oil and floatables in sedimentation chamber.	As needed, (typically every 6 months)

As a variant, organic material may be used instead of the sand media in the underground filter. Organic material has a higher cation exchange capacity and may remove more metals and other charged pollutants. Additional inspection and maintenance requirements for organic filters are similar to those for surface sand filter facilities (see *Section 16.0*)

17.5 Example Schematic

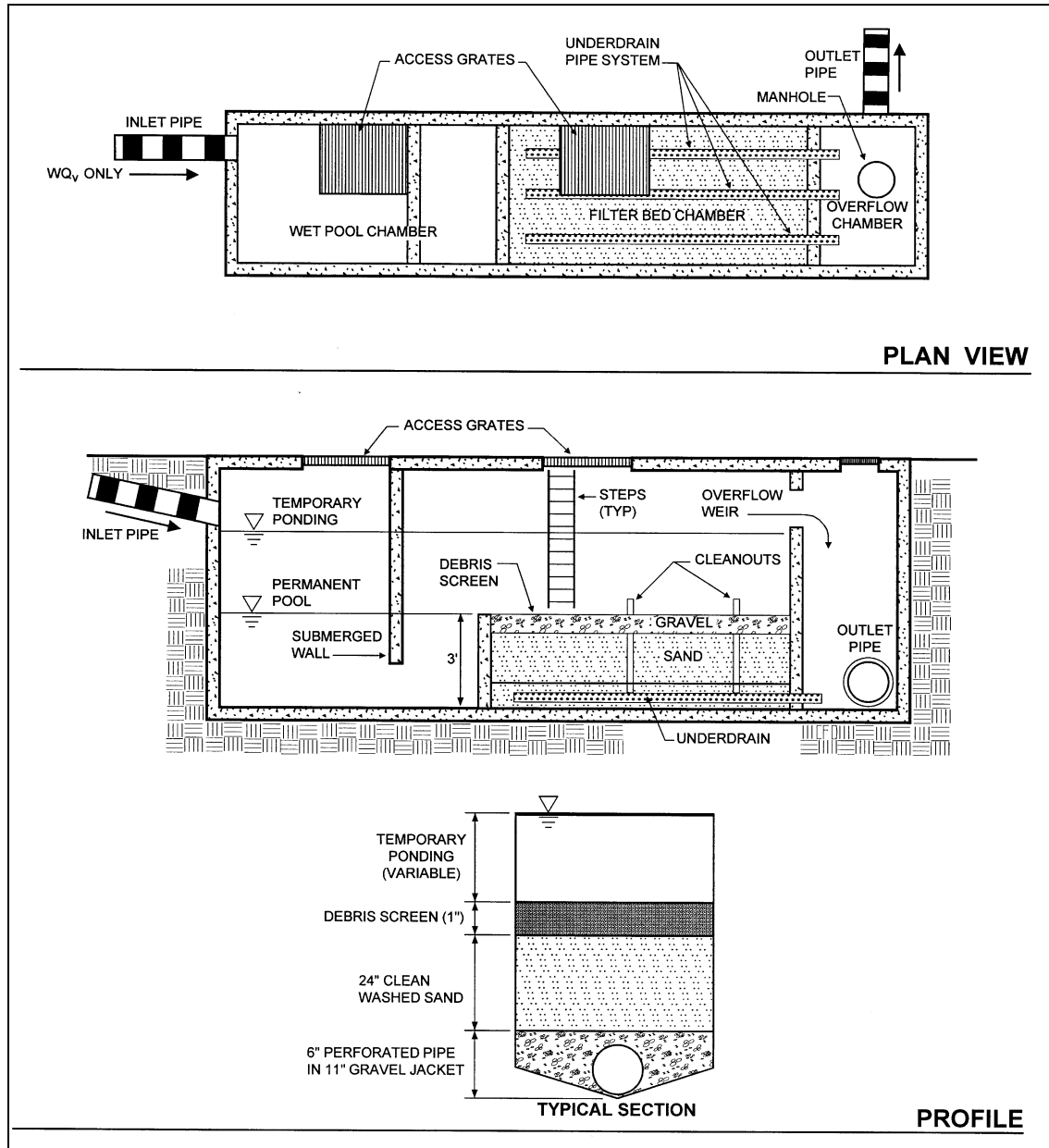
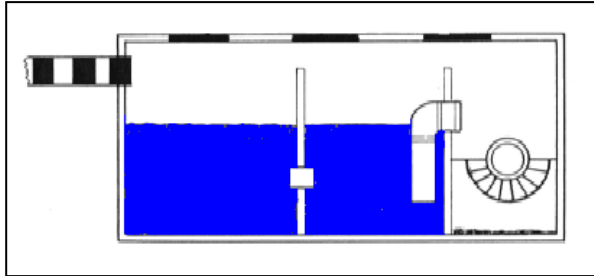

Figure 17.1 Schematic of Underground Sand Filter
 (Source: Center for Watershed Protection)

18.0 Gravity (Oil Grit) Separator

Structural Stormwater Control



Description: Hydrodynamic separation device designed to remove settleable solids, oil and grease, debris, and floatables from stormwater runoff through gravitational settling and trapping of pollutants.

KEY CONSIDERATIONS

DESIGN CRITERIA:

- Intended for hotspot, space-limited, or pretreatment applications
- Intended for the removal of settleable solids (grit and sediment) and floatable matter, including oil and grease
- Performance dependent on design and frequency of inspection and cleanout of unit

DISADVANTAGES / LIMITATIONS:

- Cannot alone achieve the 80% TSS removal target
- Limited performance data
- Dissolved pollutants are not effectively removed

MAINTENANCE REQUIREMENTS:

- Frequent maintenance required

STORMWATER MANAGEMENT SUITABILITY

- S** Water Quality Protection
- Streambank Protection**
- On-Site Flood Control**
- Downstream Flood Control**

IMPLEMENTATION CONSIDERATIONS

- L** Land Requirement
- H** Capital Cost
- H** Maintenance Burden

POLLUTANT REMOVAL

- 80%** **Total Suspended Solids**
- 50/25%** **Nutrients** - Total Phosphorus / Total Nitrogen removal
- 50%** **Metals** - Cadmium, Copper, Lead, and Zinc removal
- 40%** **Pathogens** - Coliform, Streptococci, E.Coli removal

Residential Subdivision Use: No

High Density/Ultra-Urban: Yes

Drainage Area: 1 acres max.

Soils: No restrictions

Other Considerations:

- Hotspot areas
- Pretreatment

L=Low M=Moderate H=High

18.1 General Description

Gravity separators (also known as oil-grit separators) are hydrodynamic separation devices that are designed to remove grit and heavy sediments, oil and grease, debris, and floatable matter from stormwater runoff through gravitational settling and trapping. Gravity separator units contain a permanent pool of water and typically consist of an inlet chamber, separation/storage chamber, a bypass chamber, and an access port for maintenance purposes. Runoff enters the inlet chamber where heavy sediments and solids drop out. The flow moves into the main gravity separation chamber, where further settling of suspended solids takes place. Oil and grease are skimmed and stored in a waste oil storage compartment for future removal. After moving into the outlet chamber, the clarified runoff is then discharged.

The performance of these systems is based primarily on the relatively low solubility of petroleum products in water and the difference between the specific gravity of water and the specific gravities of petroleum compounds. Gravity separators are not designed to separate other products such as solvents, detergents, or dissolved pollutants. The typical gravity separator unit may be enhanced with a pretreatment swirl concentrator chamber, oil draw-off devices that continuously remove the accumulated light liquids, and flow control valves regulating the flow rate into the unit.

Gravity separators are best used in commercial, industrial, and transportation land uses and are intended primarily as a pretreatment measure for high-density or ultra urban sites, or for use in hydrocarbon hotspots, such as gas stations and areas with high vehicular traffic. However, gravity separators cannot be used for the removal of dissolved or emulsified oils and pollutants such as coolants, soluble lubricants, glycols, and alcohols.

Since re-suspension of accumulated sediments is possible during heavy storm events, gravity separator units are typically installed off-line. Gravity separators are available as prefabricated proprietary systems from a number of different commercial vendors.

18.2 Pollutant Removal Capabilities

Testing of gravity separators has shown that they can remove between 40 and 50% of the TSS loading when used in an off-line configuration (Curran, 1996 and Henry, 1999). Gravity separators also provide removal of debris, hydrocarbons, trash and other floatables. They provide only minimal removal of nutrients and organic matter.

The following design pollutant removal rates are conservative average pollutant reduction percentages for design purposes derived from sampling data, modeling and professional judgment.

- Total Suspended Solids – 40%
- Total Phosphorus – 5%
- Total Nitrogen – 5%
- Fecal Coliform – insufficient data
- Heavy Metals – insufficient data

Actual field testing data and pollutant removal rates from an independent source should be obtained before using a proprietary gravity separator system.

18.3 Design Criteria and Specifications

The use of gravity (oil-grit) separators should be limited to the following applications:

- Pretreatment for other structural stormwater controls
- High-density, ultra urban or other space-limited development sites
- Hotspot areas where the control of grit, floatables, and/or oil and grease are required

Gravity separators are typically used for areas less than 5 acres. It is recommended that the contributing area to any individual gravity separator be limited to 1 acre or less of impervious cover.

Gravity separator systems can be installed in almost any soil or terrain. Since these devices are underground, appearance is not an issue and public safety risks are low.

Gravity separators are rate-based devices. This contrasts with most other stormwater structural controls, which are sized based on capturing and treating a specific volume.

Gravity separator units are typically designed to bypass runoff flows in excess of the design flow rate. Some designs have built-in high flow bypass mechanisms. Other designs require a diversion structure or flow splitter ahead of the device in the drainage system. An adequate outfall must be provided.

The separation chamber should provide for three separate storage volumes:

- a A volume for separated oil storage at the top of the chamber
- b A volume for settleable solids accumulation at the bottom of the chamber
- c A volume required to give adequate flow-through detention time for separation of oil and sediment from the stormwater flow

The total wet storage of the gravity separator unit should be at least 400 cubic feet per contributing impervious acre.

The minimum depth of the permanent pools should be 4 feet.

Horizontal velocity through the separation chamber should be 1 to 3 ft/min or less. No velocities in the device should exceed the entrance velocity.

A trash rack should be included in the design to capture floating debris, preferably near the inlet chamber to prevent debris from becoming oil impregnated.

Ideally, a gravity separator design will provide an oil draw-off mechanism to a separate chamber or storage area.

Adequate maintenance access to each chamber must be provided for inspection and cleanout of a gravity separator unit.

Gravity separator units should be watertight to prevent possible groundwater contamination.

The design criteria and specifications of a proprietary gravity separator unit should be obtained from the manufacturer.

18.4 Inspection and Maintenance Requirements

Activity	Schedule
<ul style="list-style-type: none"> • Inspect the gravity separator unit for structural problems, accumulated pollutants, and mosquito larvae. 	Regularly (quarterly)
<ul style="list-style-type: none"> • Clean out sediment, oil and grease, and floatables, using catch basin cleaning equipment (vacuum pumps). Manual removal of pollutants may be necessary. 	As Needed

Additional Maintenance Considerations and Requirements

Additional maintenance requirements for a proprietary system should be obtained from the manufacturer.

Failure to provide adequate inspection and maintenance can result in the re-suspension of accumulated solids. Frequency of inspection and maintenance is dependent on land use, climatological conditions, and the design of gravity separator.

Proper disposal of oil, solids, and floatables removed from the gravity separator must be ensured.

If mosquito larvae are present in the unit, treat with larvacide. (See [Section 19.4](#))

18.5 Example Schematic

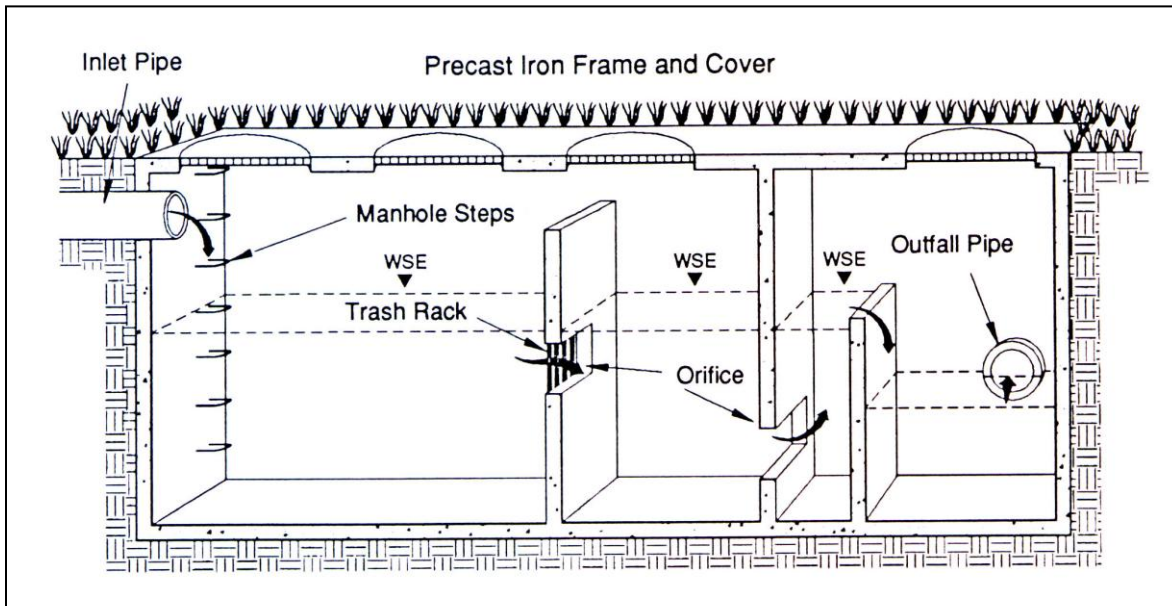

Figure 18.1 Schematic of an Example Gravity (Oil-Grit) Separator

(Source: NVRC, 1992[1])

19.0 Downspout Drywell

Structural Stormwater Control

Description: Drywells are essentially perforated manholes, but they can be manufactured in various sizes. Located underground, they allow stormwater infiltration even in highly urbanized areas. They should be used in conjunction with some type of pretreatment devices where there are minimal risks of groundwater contamination.

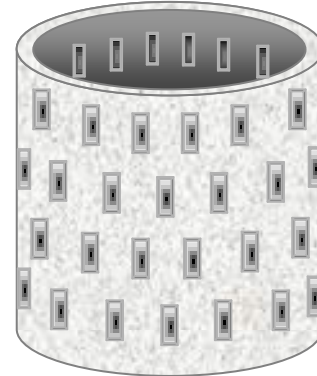

KEY CONSIDERATIONS

DESIGN CRITERIA:

- Intended for space-limited applications
- Like other infiltration devices, drywells should not be used for stormwater containing high sediment loads to minimize clogging

ADVANTAGES / BENEFITS:

- Filtration provides pollutant removal capability in adjacent soil
- Decreases peak flow rates

DISADVANTAGES / LIMITATIONS:

- Subsurface structure considered an injection well and may require special permit

STORMWATER MANAGEMENT SUITABILITY

- P** Water Quality Protection
- S** Streambank Protection
- O** On-Site Flood Control
- D** Downstream Flood Control

IMPLEMENTATION CONSIDERATIONS

- L** Land Requirement
- L** Capital Cost
- M** Maintenance Burden

Residential Subdivision Use: Yes

High Density/Ultra-Urban: Yes

Drainage Area: No restrictions

Soils: Pervious soils required (0.5 in/hr or greater)

L=Low M=Moderate H=High

POLLUTANT REMOVAL

- 80%** **Total Suspended Solids**
- 60/60%** **Nutrients** - Total Phosphorus / Total Nitrogen removal
- 90%** **Metals** - Cadmium, Copper, Lead, and Zinc removal
- 90%** **Pathogens** - Coliform, Streptococci, E.Coli removal

19.1 General Description

Drywells are infiltration devices that have historically been used to dispose of excess runoff without extensive infrastructure. Its minimal land requirements allow it to be used in highly urbanized areas. Drywells used for stormwater disposal are considered Class V injection devices by the EPA and fall under the Texas UIC program. Concerns about contaminating aquifers limit their application to “clean” runoff, such as roofdrains, and require pretreatment devices to remove sediments and other pollutants.

Drywells should not be used in areas near drinking water wells, with industrial land use, with high groundwater tables, a substrate of fractured rock, or slow-draining soils. Drywell design should be overseen by a licensed engineer.

19.2 Pollutant Removal Capabilities

Pollutant removal is similar to infiltration trenches (see *Section 20.0*), but care should be taken to avoid clogging with sediments.

- Total Suspended Solids – 80%
- Total Phosphorus – 60%
- Total Nitrogen – 60%
- Fecal Coliform – 90%
- Heavy Metals – 90%

19.3 Design Criteria and Specifications

The drywell should be located at least 5 feet from the nearest property line and 10 feet away from an occupied building.

Drywells shall be located at least 200 feet from the tops of slopes more than 10 feet high and steeper than 2h:1v.

The drywell shall be excavated in native soil, uncompacted by heavy equipment.

A qualified professional shall conduct infiltration testing. The surrounding soil should have a minimum infiltration rate of 0.5 inches per hour.

The drywell shall be surrounded by a 12 inch thick layer of $\frac{3}{4}$ " to 2 $\frac{1}{2}$ " round rock.

There should be at least four feet between the bottom of the drywell and the seasonal high ground water table or bedrock.

A pretreatment device should be installed upstream of the drywell to remove sediments and other pollutants.

The drywell shall be sized in accordance with the simplified sizing criteria.

The drywell should not be located next to trees, since roots may penetrate drywell and clog it.

Access should be provided for drywell maintenance via a secured manhole or cleanout.

19.4 Inspection and Maintenance Requirements

The inspection and maintenance requirements for drywells are designed to maintain an adequate drainage rate through the drywell, while avoiding groundwater contamination.

Activity	Schedule
Ensure that inflow is unimpeded. Clean out accumulated sediment/ debris and dispose of properly.	Quarterly and within 48 hours of major storms
Inspect pretreatment device and clean if necessary. Cleaning shall be done without the used of detergents or solvents.	As needed, based on minimum annual inspection
Inspect area surrounding the drywell for waterlogged soils at surface, indicating drywell failure. Clogged drywells must be replaced.	Inspect between 24 - 48 hours after major storms
Pest control measures shall be taken if rodents or mosquitoes are found to be present. Holes in the ground around the drywell shall be filled and a low toxicity mosquito larvacide, such as Bacillus thuringiensis (Bti), Bacillus Sphearicus (Bsph) or Methoprene (insect growth regulator) applied by a licensed individual, if necessary.	As needed

19.5 Example Schematic

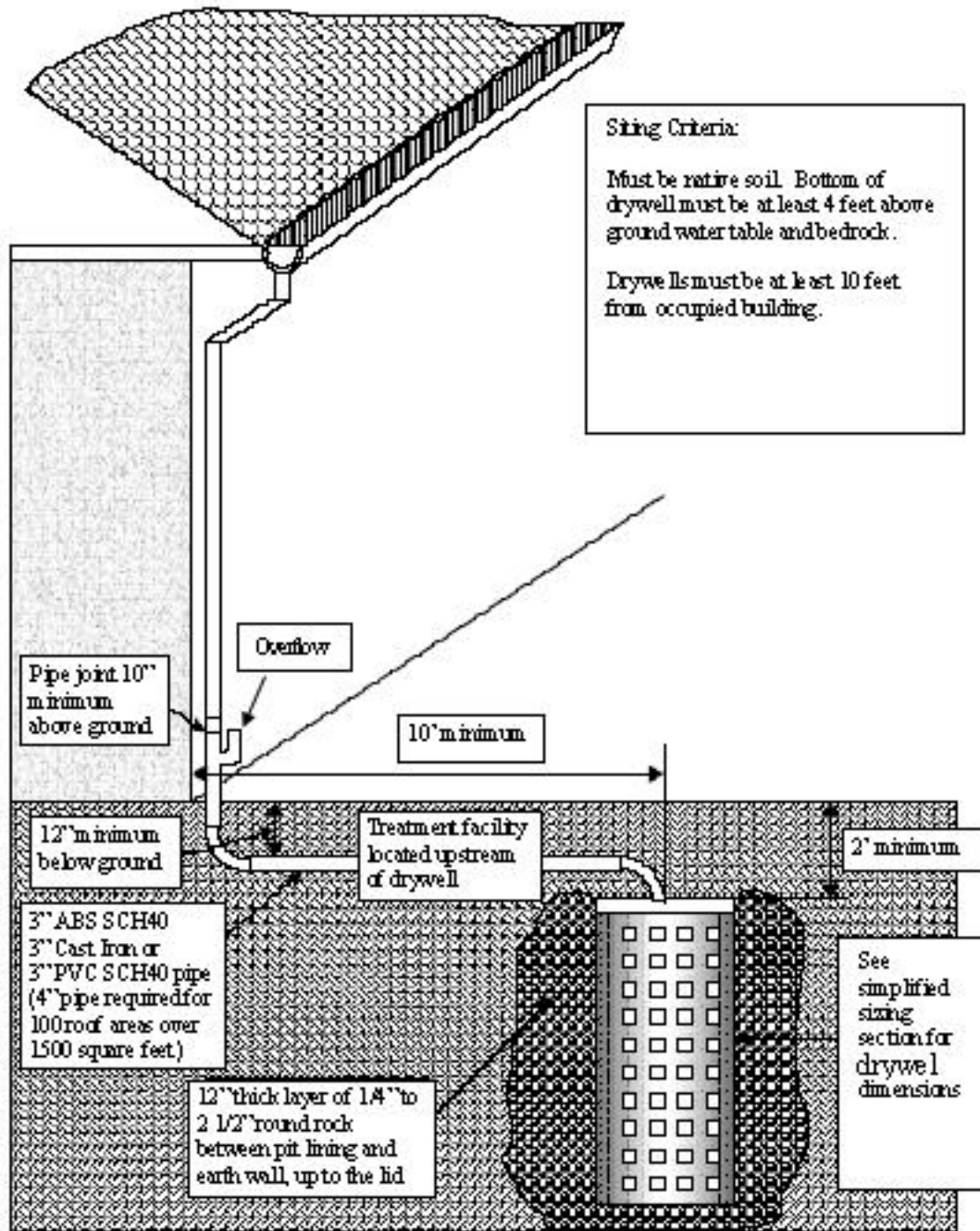

Figure 19.1 Schematic of Drywell System

(Source: City of Portland, Oregon)

20.0 Infiltration Trench

Structural Stormwater Control



Description: Excavated trench filled with stone aggregate used to capture and allow infiltration of stormwater runoff into the surrounding soils from the bottom and sides of the trench.

KEY CONSIDERATIONS

DESIGN CRITERIA:

- Soil infiltration rate of 0.5 in/hr or greater required
- Excavated trench (3 to 8 foot depth) filled with stone media (1.5- to 2.5-inch diameter); pea gravel, and sand filter layers
- A sediment forebay and grass channel, or equivalent upstream pretreatment, must be provided
- Observation well to monitor percolation

ADVANTAGES / BENEFITS:

- Provides for groundwater recharge
- Good for small sites with porous soils

DISADVANTAGES / LIMITATIONS:

- Potential for groundwater contamination
- High clogging potential; should not be used on sites with fine-particled soils (clays or silts) in drainage area
- Significant setback requirements
- Restrictions in karst areas
- Geotechnical testing required, two borings per facility

MAINTENANCE REQUIREMENTS:

- Inspect for clogging
- Remove sediment from forebay
- Replace pea gravel layer as needed

STORMWATER MANAGEMENT SUITABILITY

- P** Water Quality Protection
- S** Streambank Protection
- On-Site Flood Control**
- Downstream Flood Control**

IMPLEMENTATION CONSIDERATIONS

- M** Land Requirement
- H** Capital Cost
- H** Maintenance Burden

Residential Subdivision Use: Yes

High Density/Ultra-Urban: Yes

Drainage Area: 5 acres max.

Soils: Pervious soils required (0.5 in/hr or greater)

Other Considerations:

- Must not be placed under pavement or concrete

L=Low M=Moderate H=High

POLLUTANT REMOVAL (DRY SWALE)

- 80%** Total Suspended Solids
- 60/60%** Nutrients - Total Phosphorus / Total Nitrogen removal
- 90%** Metals - Cadmium, Copper, Lead, and Zinc removal
- 90%** Pathogens - Coliform, Streptococci, E.Coli removal

20.1 General Description

Infiltration trenches are excavations typically filled with stone to create an underground reservoir for stormwater runoff (see Figure 20.1). This runoff volume gradually infiltrates through the bottom and sides of the trench into the subsoil over a 2-day period and eventually reaches the water table. By diverting runoff into the soil, an infiltration trench not only treats the water quality volume, but also helps to preserve the natural water balance on a site and can recharge groundwater and preserve baseflow. Due to this fact, infiltration systems are limited to areas with highly porous soils where the water table and/or bedrock are located well below the bottom of the trench. In addition, infiltration trenches must be carefully sited to avoid the potential of groundwater contamination.

Infiltration trenches are not intended to trap sediment and must always be designed with a sediment forebay and grass channel or filter strip, or other appropriate pretreatment measures to prevent clogging and failure. Due to their high potential for failure, these facilities must only be considered for sites where upstream sediment control can be ensured.

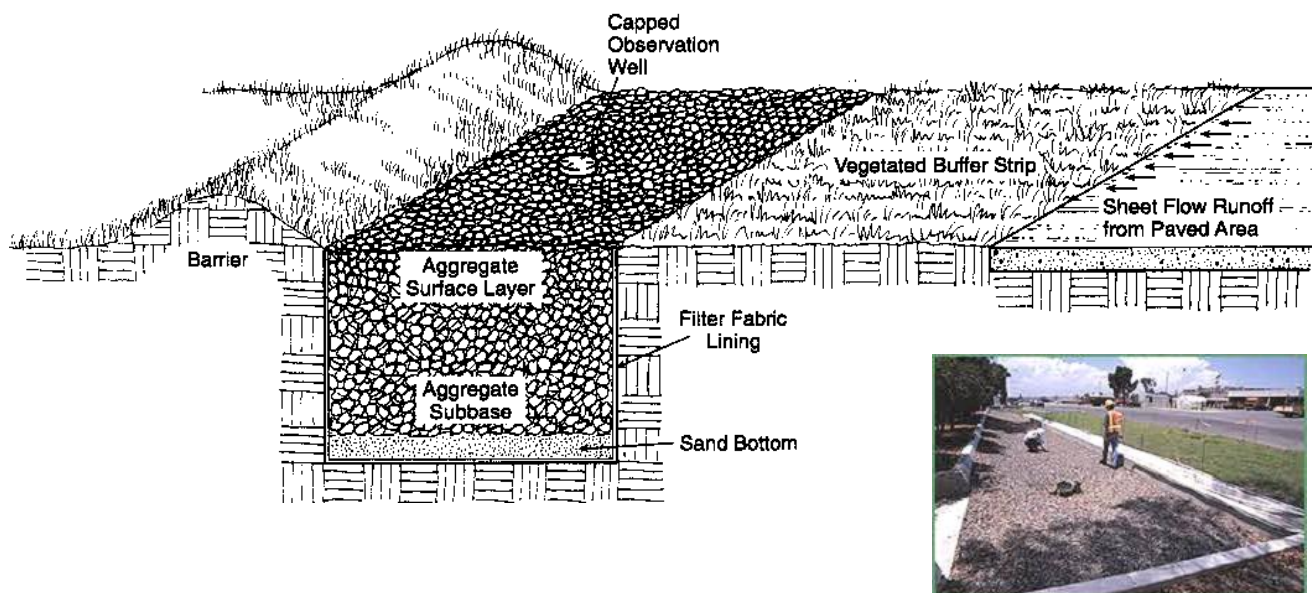

Figure 20.1 Infiltration Trench Example

20.2 Stormwater Management Suitability

Infiltration trenches are designed primarily for stormwater quality, i.e. the removal of stormwater pollutants. However, they can provide limited runoff quantity control, particularly for smaller storm events. For some smaller sites, trenches can be designed to capture and infiltrate the streambank protection volume (SP_v) in addition to WQ_v. An infiltration trench will need to be used in conjunction with another structural control to provide flood control, if required.

Water Quality Protection

Using the natural filtering properties of soil, infiltration trenches can remove a wide variety of pollutants from stormwater through sorption, precipitation, filtering, and bacterial and chemical degradation. Sediment load and other suspended solids are removed from runoff by pretreatment measures in the facility that treats flows before they reach the trench surface.

[Section 20.3](#) provides pollutant removal efficiencies that can be used for planning and design purposes.

Streambank Protection

For smaller sites, an infiltration trench may be designed to capture and infiltrate the entire streambank protection volume SP_v in either an off- or on-line configuration. For larger sites, or where only the WQ_v is diverted to the trench, another structural control must be used to provide SP_v extended detention.

Flood Control

Infiltration trench facilities must provide flow diversion and/or be designed to safely pass extreme storm flows and protect the filter bed and facility.

The volume of runoff removed and treated by the infiltration trench may be taken in the on-site and/or downstream flood control calculations (see Section 1.0).

20.3 Pollutant Removal Capabilities

An infiltration trench is presumed to be able to remove 80% of the total suspended solids load in typical urban post-development runoff when sized, designed, constructed, and maintained in accordance with the recommended specifications. Undersized or poorly designed infiltration trenches can reduce TSS removal performance.

The following design pollutant removal rates are conservative average pollutant reduction percentages for design purposes derived from sampling data, modeling, and professional judgment. In a situation where a removal rate is not deemed sufficient, additional controls may be put in place at the given site in a series or “treatment train” approach.

- Total Suspended Solids – 80%
- Total Phosphorus – 60%
- Total Nitrogen – 60%
- Fecal Coliform – 90%
- Heavy Metals – 90%

For additional information and data on pollutant removal capabilities for infiltration trenches, see the National Pollutant Removal Performance Database (2nd Edition) available at www.cwp.org and the National Stormwater Best Management Practices (BMP) Database at www.bmpdatabase.org

20.4 Application and Site Feasibility Criteria

Infiltration trenches are generally suited for medium-to-high density residential, commercial, and institutional developments where the subsoil is sufficiently permeable to provide a reasonable infiltration rate and the water table is low enough to prevent groundwater contamination. They are applicable primarily for impervious areas where there are not high levels of fine particulates (clay/silt soils) in the runoff and should only be considered for sites where the sediment load is relatively low.

Infiltration trenches can either be used to capture sheet flow from a drainage area or function as an off-line device. Due to the relatively narrow shape, infiltration trenches can be adapted to many different types of sites and can be utilized in retrofit situations. Unlike some other structural stormwater controls, they can easily fit into the margin, perimeter, or other unused areas of developed sites.

To protect groundwater from potential contamination, runoff from designated hotspot land uses or activities must not be infiltrated. Infiltration trenches should not be used for manufacturing and industrial sites, where there is a potential for high concentrations of soluble pollutants and heavy metals. In addition, infiltration should not be considered for areas with a high pesticide concentration. Infiltration trenches are also not suitable in areas with karst geology without adequate geotechnical testing by qualified individuals and in accordance with local requirements.

The following criteria should be evaluated to ensure the suitability of an infiltration trench for meeting stormwater management objectives on a site or development.

General Feasibility

- Suitable for Residential Subdivision Usage – YES
- Suitable for High Density/Ultra Urban Areas – YES
- Regional Stormwater Control – NO

Physical Feasibility - Physical Constraints at Project Site

- Drainage Area – 5 acres maximum
- Space Required – Will vary depending on the depth of the facility
- Site Slope – No more than 6% slope (for pre-construction facility footprint)
- Minimum Head – Elevation difference needed at a site from the inflow to the outflow: 1 foot
- Minimum Depth to Water Table – 4 feet recommended between the bottom of the infiltration trench and the elevation of the seasonally high water table
- Soils – Infiltration rate greater than 0.5 inches per hour required (typically hydrologic group “A”, some group “B” soils)

Other Constraints / Considerations

- Aquifer Protection – No hotspot runoff allowed; meet setback requirements in design criteria

20.5 Planning and Design Criteria

*The following criteria are to be considered **minimum** standards for the design of an infiltration trench facility. Consult with the local review authority to determine if there are any variations to these criteria or additional standards that must be followed.*

A Location and Siting

To be suitable for infiltration, underlying soils should have an infiltration rate (f_c) of 0.5 inches per hour or greater, as initially determined from NRCS soil textural classification and subsequently confirmed by field geotechnical tests. The minimum geotechnical testing is one test hole per 5,000 square feet, with a minimum of two borings per facility (taken within the proposed limits of the facility). Infiltration trenches cannot be used in fill soils.

Infiltration trenches should have a contributing drainage area of 5 acres or less.

Soils on the drainage area tributary to an infiltration trench should have a clay content of less than 20% and a silt/clay content of less than 40% to prevent clogging and failure.

There should be at least 4 feet between the bottom of the infiltration trench and the elevation of the seasonally high water table.

Clay lenses, bedrock or other restrictive layers below the bottom of the trench will reduce infiltration rates unless excavated.

Minimum setback requirements for infiltration trench facilities (when not specified by local ordinance or criteria):

From a property line – 10 feet

From a building foundation – 25 feet

From a private well – 100 feet

From a public water supply well – 1,200 feet

From a septic system tank/leach field – 100 feet

From surface waters – 100 feet

From surface drinking water sources – 400 feet (100 feet for a tributary)

When used in an off-line configuration, the water quality protection volume (WQ_v) is diverted to the infiltration trench through the use of a flow splitter. Stormwater flows greater than the WQ_v are diverted to other controls or downstream using a diversion structure or flow splitter.

To reduce the potential for costly maintenance and/or system reconstruction, it is strongly recommended that the trench be located in an open or lawn area, with the top of the structure as close to the ground surface as possible. Infiltration trenches shall not be located beneath paved surfaces, such as parking lots.

Infiltration trenches are designed for intermittent flow and must be allowed to drain and allow re-aeration of the surrounding soil between rainfall events. They must not be used on sites with a continuous flow from groundwater, sump pumps, or other sources.

B General Design

A well-designed infiltration trench consists of:

Excavated shallow trench backfilled with sand, coarse stone, and pea gravel, and lined with a filter fabric

Appropriate pretreatment measures

One or more observation wells to show how quickly the trench dewater or to determine if the device is clogged

Figure 20.2 provides a plan view and profile schematic for the design of an off-line infiltration trench facility. An example of an on-line infiltration trench is shown in Figure 20.1.

C Physical Specifications / Geometry

The required trench storage volume is equal to the water quality protection volume (WQ_v). For smaller sites, an infiltration trench can be designed with a larger storage volume to include the streambank protection volume (SP_v).

A trench must be designed to fully dewater the entire WQ_v within 24 to 48 hours after a rainfall event. The slowest infiltration rate obtained from tests performed at the site should be used in the design calculations.

Trench depths should be between 3 and 8 feet, to provide for easier maintenance. The width of a trench must be less than 25 feet.

Broader, shallow trenches reduce the risk of clogging by spreading the flow over a larger area for infiltration.

The surface area required is calculated based on the trench depth, soil infiltration rate, aggregate void space, and fill time (assume a fill time of 2 hours for most designs).

The bottom slope of a trench should be flat across its length and width to evenly distribute flows, encourage uniform infiltration through the bottom, and reduce the risk of clogging.

The stone aggregate used in the trench should be washed, bank-run gravel, 1.5 to 2.5 inches in diameter with a void space of about 40%. Aggregate contaminated with soil shall not be used. A porosity value (void space/total volume) of 0.32 should be used in calculations, unless aggregate specific data exist.

A 6-inch layer of clean, washed sand is placed on the bottom of the trench to encourage drainage and prevent compaction of the native soil while the stone aggregate is added.

The infiltration trench is lined on the sides and top by an appropriate geotextile filter fabric that prevents soil piping but has greater permeability than the parent soil. The top layer of filter fabric is located 2 to 6

inches from the top of the trench and serves to prevent sediment from passing into the stone aggregate. Since this top layer serves as a sediment barrier, it will need to be replaced more frequently and must be readily separated from the side sections.

The top surface of the infiltration trench above the filter fabric is typically covered with pea gravel. The pea gravel layer improves sediment filtering and maximizes the pollutant removal in the top of the trench. In addition, it can easily be removed and replaced should the device begin to clog. Alternatively, the trench can be covered with permeable topsoil and planted with grass in a landscaped area.

An observation well must be installed in every infiltration trench and should consist of a perforated PVC pipe, 4 to 6 inches in diameter, extending to the bottom of the trench (see Figure 20.3 for an observation well detail). The observation well will show the rate of dewatering after a storm, as well as provide a means of determining sediment levels at the bottom and when the filter fabric at the top is clogged and maintenance is needed. It should be installed along the centerline of the structure, flush with the ground elevation of the trench. A visible floating marker should be provided to indicate the water level. The top of the well should be capped and locked to discourage vandalism and tampering.

The trench excavation should be limited to the width and depth specified in the design. Excavated material should be placed away from the open trench so as not to jeopardize the stability of the trench sidewalls. The bottom of the excavated trench shall not be loaded in a way that causes soil compaction, and should be scarified prior to placement of sand. The sides of the trench shall be trimmed of all large roots. The sidewalls shall be uniform with no voids and scarified prior to backfilling. All infiltration trench facilities should be protected during site construction and should be constructed after upstream areas have been stabilized.

D Pretreatment / Inlets

Pretreatment facilities **must always** be used in conjunction with an infiltration trench to prevent clogging and failure.

For a trench receiving sheet flow from an adjacent drainage area, the pretreatment system should consist of a vegetated filter strip with a minimum 25-foot length. A vegetated buffer strip around the entire trench is required if the facility is receiving runoff from both directions. If the infiltration rate for the underlying soils is greater than 2 inches per hour, 50% of the WQ_v should be pretreated by another method prior to reaching the infiltration trench.

For an off-line configuration, pretreatment should consist of a sediment forebay, vault, plunge pool, or similar sedimentation chamber (with energy dissipaters) sized to 25% of the water quality protection volume (WQ_v). Exit velocities from the pretreatment chamber must be nonerosive for the 2-year design storm.

E Outlet Structures

Outlet structures are not required for infiltration trenches.

F Emergency Spillway

Typically, for off-line designs, there is no need for an emergency spillway. However, a nonerosive overflow channel should be provided to pass safely flows that exceed the storage capacity of the trench to a stabilized downstream area or watercourse.

G Maintenance Access

Adequate access should be provided to an infiltration trench facility for inspection and maintenance.

H Safety Features

In general, infiltration trenches are not likely to pose a physical threat to the public and do not need to be fenced.

I Landscaping

Vegetated filter strips and buffers should fit into and blend with surrounding area. Native grasses are preferable, if compatible. The trench may be covered with permeable topsoil and planted with grass in a landscaped area

J Additional Site-Specific Design Criteria and Issues

Physiographic Factors - Local terrain design constraints

Low Relief – No additional criteria

High Relief – Maximum site slope of 6%

Karst – Not suitable without adequate geotechnical testing

Special Downstream Watershed Considerations

No additional criteria

20.6 Design Procedures

Step 1 Compute runoff control volumes from the *integrated* Design Focus Areas

Calculate the Water Quality Protection Volume (WQ_v), Streambank Protection Volume (SP_v), and the Flood mitigation storm (Q_t).

Details on the *integrated* Design Focus Areas are found in [Section 1.0 of the Planning Technical Manual](#).

Step 2 Determine if the development site and conditions are appropriate for the use of an infiltration trench.

Consider the Application and Site Feasibility Criteria in [Sections 20.4 and 20.5 \(A\)](#) (Location and Siting).

Step 3 Confirm local design criteria and applicability

Consider any special site-specific design conditions/criteria from [Section 20.5 \(J\)](#) (Additional Site-Specific Design Criteria and Issues).

Check with local officials and other agencies to determine if there are any additional restrictions and/or surface water or watershed requirements that may apply.

Step 4 Compute WQ_v peak discharge (Q_{wq})

The peak rate of discharge for water quality design storm is needed for sizing of off-line diversion (see [Section 1.5 of the Hydrology Technical Manual](#)).

- (a) Using WQ_v (or total volume to be infiltrated), compute CN
- (b) Compute time of concentration using TR-55 method
- (c) Determine appropriate unit peak discharge from time of concentration
- (d) Compute Q_{wq} from unit peak discharge, drainage area, and WQ_v .

Step 5 Size flow diversion structure, if needed

A flow regulator (or flow splitter diversion structure) should be supplied to divert the WQ_v to the infiltration trench.

Size low flow orifice, weir, or other device to pass Q_{wq} .

Step 6 Size infiltration trench

The area of the trench can be determined from the following equation:

$$A = \frac{WQ_v}{(nd + kT / 12)} \quad (20.1)$$

where:

- A = Surface Area
- WQ_v = Water Quality Protection Volume (or total volume to be infiltrated)
- n = porosity
- d = trench depth (feet)
- k = percolation (inches/hour)
- T = Fill Time (time for the practice to fill with water), in hours

A porosity value $n = 0.32$ should be used.

All infiltration systems should be designed to fully dewater the entire WQ_v within 24 to 48 hours after the rainfall event.

A fill time $T=2$ hours can be used for most designs

See [Section 20.5 \(C\)](#) (Physical Specifications/Geometry) for more specifications.

Step 7 Determine pretreatment volume and design pretreatment measures

Size pretreatment facility to treat 25% of the water quality protection volume (WQ_v) for off-line configurations.

See [Section 20.5 \(D\)](#) (Pretreatment / Inlets) for more details.

Step 8 Design spillway(s)

Adequate stormwater outfalls should be provided for the overflow exceeding the capacity of the trench, ensuring nonerosive velocities on the down-slope.

See [Section 29.5](#) for an Infiltration Trench Design Example

20.7 Inspection and Maintenance Requirements

Activity	Schedule
<ul style="list-style-type: none"> • Ensure that contributing area, facility, and inlets are clear of debris. • Ensure that the contributing area is stabilized. • Remove sediment and oil/grease from pretreatment devices, as well as overflow structures. • Mow grass filter strips as necessary. Remove grass clippings. 	Monthly

Table 20.1 Typical Maintenance Activities for Infiltration Trenches	
Activity	Schedule
<ul style="list-style-type: none"> • Check observation wells following 3 days of dry weather. Failure to percolate within this time period indicates clogging. • Inspect pretreatment devices and diversion structures for sediment build-up and structural damage. • Remove trees that start to grow in the vicinity of the trench. 	Semi-annual Inspection
<ul style="list-style-type: none"> • Replace pea gravel/topsoil and top surface filter fabric (when clogged). 	As needed
<ul style="list-style-type: none"> • Perform total rehabilitation of the trench to maintain design storage capacity. • Excavate trench walls to expose clean soil. 	Upon Failure

(Source: EPA, 1999)

Additional Maintenance Considerations and Requirements

A record should be kept of the dewatering time of an infiltration trench to determine if maintenance is necessary.

Removed sediment and media may usually be disposed of in a landfill.



Regular inspection and maintenance is critical to the effective operation of infiltration trench facilities as designed. Maintenance responsibility for an infiltration trench should be vested with a responsible authority by means of a legally binding and enforceable maintenance agreement that is executed as a condition of plan approval.

20.8 Example Schematics

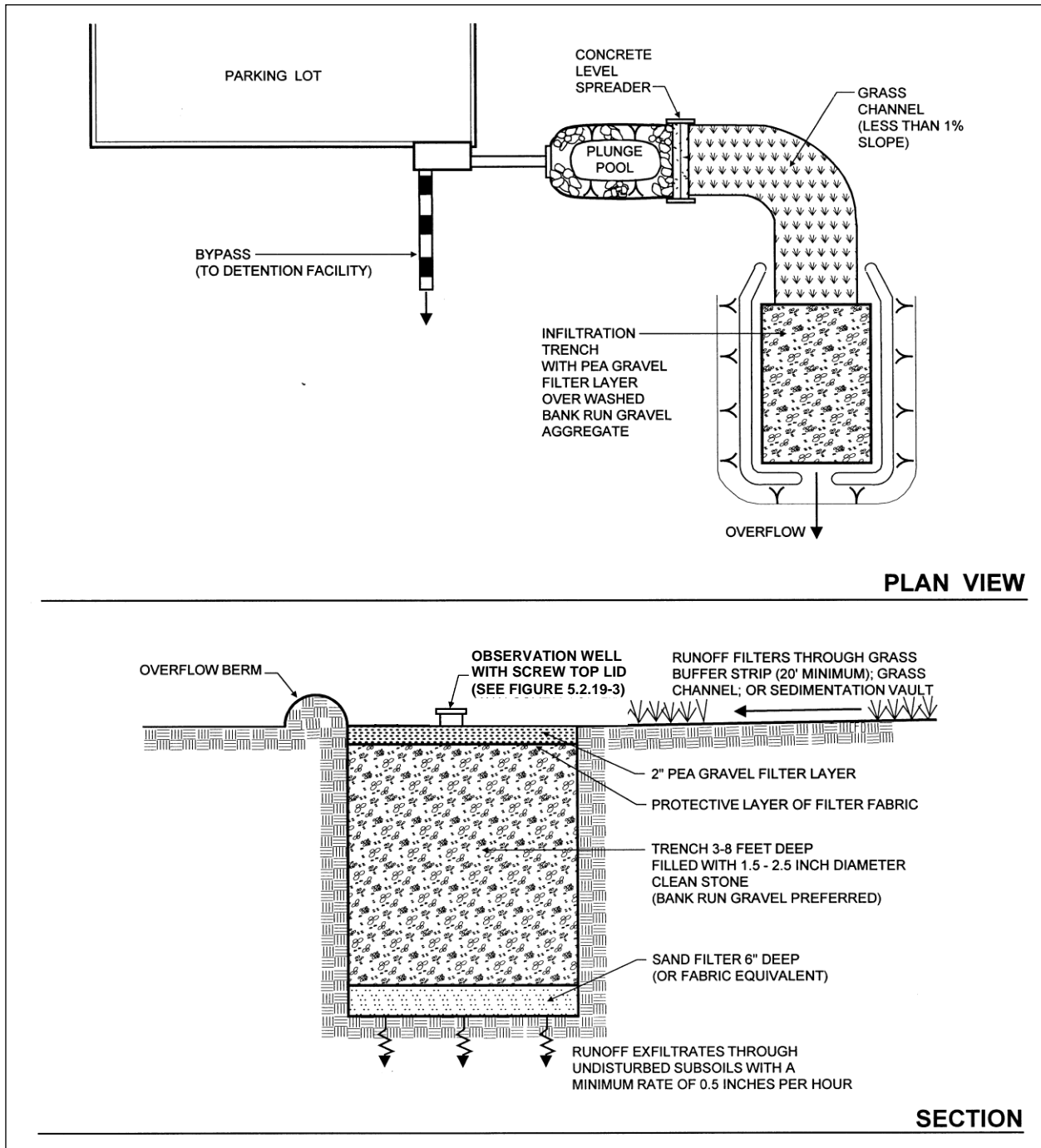

Figure 20.2 Schematic of Infiltration Trench

(Source: Center for Watershed Protection)

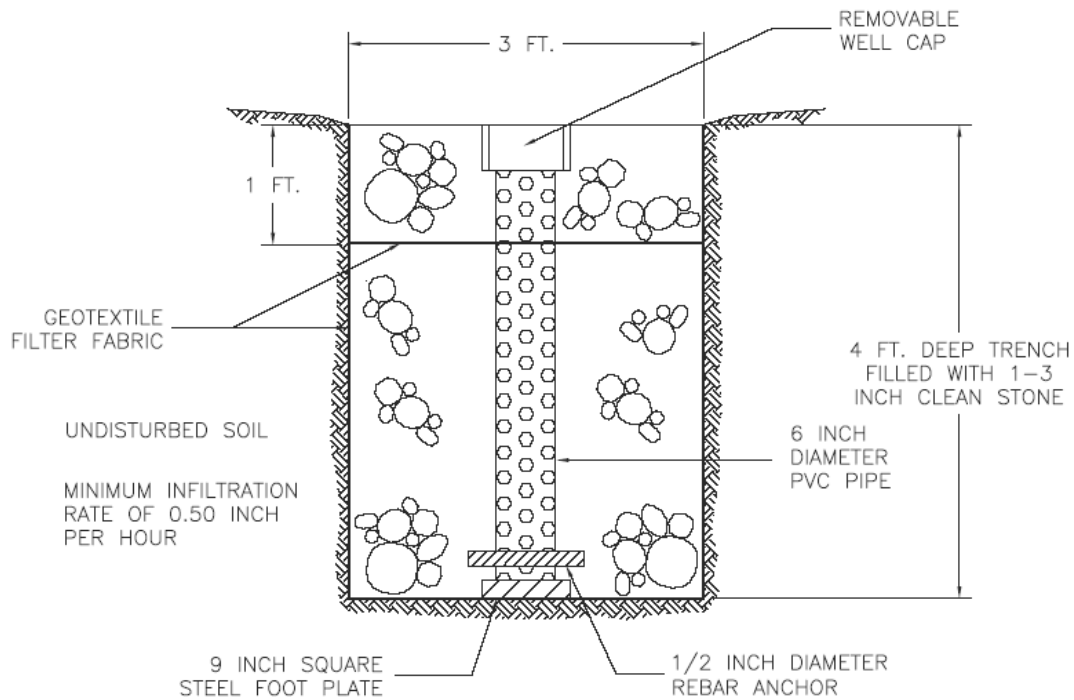

Figure 20.3 Observation Well Detail

- The aggregate material for the trench should consist of a clean aggregate with a maximum diameter of 3 inches and a minimum diameter of 1.5 inches.
- The aggregate should be graded such that there will be few aggregates smaller than the selected size. For design purposes, void space for these aggregates may be assumed to be in the range of 30 to 40%.
- A 6-inch layer of clean, washed sand is placed on the bottom of the trench to encourage drainage and prevent compaction of the native soil, while the stone aggregate is added.
- The aggregate should be completely surrounded with an engineering filter fabric. If the trench has an aggregate surface, filter fabric should surround all of the aggregate fill material except for the top 1 foot.
- The observation well should consist of perforated PVC pipe, 4 to 6 inches diameter, located in the center of the structure, and be constructed flush with the ground elevation of the trench.
- The PVC pipe should have a factory attached cast iron or high impact to prevent rotation when removing the screw top lid.
- The screw top lid should be cast iron and clearly labeled as an observation well.

20.9 Design Forms

Design Procedure Form: Infiltration Trench

PRELIMINARY HYDROLOGIC CALCULATIONS

- 1a. Compute WQ_v volume requirements
 Compute Runoff Coefficient, R_v
 Compute WQ_v
- 1b. Compute SP_v
 Compute average release rate
 Compute Q_p (100-year detention volume required)
 Compute (as necessary) Q_r

$R_v =$ _____
 $WQ_v =$ _____ acre-ft
 $SP_v =$ _____ acre-ft
 release rate = _____ cfs
 $Q_p =$ _____ acre-ft
 $Q_r =$ _____ cfs

INFILTRATION TRENCH DESIGN

- 2. Is the use of a infiltration trench appropriate?
- 3. Confirm local design criteria and applicability.
- 4. Compute WQ_p peak discharge (Q_{wq})
 Compute Curve Number
 Compute Time of Concentration t_c
 Compute Q_{wq}
- 5. Size infiltration trench
 Width must be less than 25 ft
- 6. Size the flow diversion structures
 Low flow orifice from orifice equation
 $Q = CA(2gh)^{0.5}$
 Overflow weir from weir equation
 $Q = CLH^{3/2}$
- 7. Pretreatment volume (for offline designs)
 $Vol_{pre} = 0.25(WQ_v)$
- 8. Design spillway(s)

See subsections 5.2.19.4 and 5.2.19.5 - A

See subsection 5.2.19.5 - J

$CN =$ _____
 $t_c =$ _____ hour
 $Q_{wq} =$ _____ cfs
 $Area =$ _____ ft^2
 $Width =$ _____ ft
 $Length =$ _____ ft

$A =$ _____ ft^2
 $diam. =$ _____ inch
 $Length =$ _____ ft

$Vol_{pre} =$ _____ ft^3

Notes: _____

21.0 Soakage Trench

Structural Stormwater Control



Description: Soakage trenches are a variation of infiltration trenches. Soakage trenches drain through a perforated pipe buried in gravel. They are used in highly impervious areas where conditions do not allow surface infiltration and where pollutant concentrations in runoff are minimal (i.e. non-industrial rooftops). They may be used in conjunction with other stormwater devices, such as draining downspouts or planter boxes.

KEY CONSIDERATIONS

DESIGN CRITERIA:

- Intended for space-limited applications
- Like other infiltration devices, soakage trenches should not be used for stormwater containing high sediment loads to minimize clogging

ADVANTAGES / BENEFITS:

- Filtration provides pollutant removal capability
- Reservoir decreases peak flow rates

DISADVANTAGES / LIMITATIONS:

- Subsurface pipe considered an injection well and may require special permit

STORMWATER MANAGEMENT SUITABILITY

- P** Water Quality Protection
- S** Streambank Protection
- On-Site Flood Control**
- Downstream Flood Control**

IMPLEMENTATION CONSIDERATIONS

- M** Land Requirement
- H** Capital Cost
- H** Maintenance Burden

Residential Subdivision Use: Yes
High Density/Ultra-Urban: Yes
Drainage Area: 5 acres max
Soils: Pervious soils required (0.5 in/hr or greater)

L=Low M=Moderate H=High

POLLUTANT REMOVAL

- 80%** **Total Suspended Solids**
- 60/60%** **Nutrients** - Total Phosphorus / Total Nitrogen removal
- 90%** **Metals** - Cadmium, Copper, Lead, and Zinc removal
- 90%** **Pathogens** - Coliform, Streptococci, E.Coli removal

21.1 General Description

Soakage trenches represent a variation of infiltration trench. Regular infiltration trenches drain from the surface, but in highly urbanized areas there is not often a suitable area available for this type of setup. Soakage trenches utilize a perforated pipe embedded within the trench, thereby minimizing the surface area required for the device. They can even be located under pavement.

Soakage trenches used for stormwater disposal are considered Class V injection devices by the EPA and fall under the Texas UIC program.

21.2 Pollutant Removal Capabilities

Pollutant removal is similar to infiltration trenches (see [Section 16.0](#)), but care should be taken to avoid clogging with sediments.

- Total Suspended Solids – 80%
- Total Phosphorus – 60%
- Total Nitrogen – 60%
- Fecal Coliform – 90%
- Heavy Metals – 90%

21.3 Design Criteria and Specifications

- The soakage trench should be located at least 5 feet from the nearest property line and 10 feet away from an occupied building (they may be closer to other structures, such as a parking garage or other structures on piers).
- The trench shall be excavated in native soil, uncompacted by heavy equipment.
- The trench should be at least 3 feet deep and 2.5 feet wide as shown in Figure 21.1. The exact dimensions will be dependent on the drainage characteristics of the surrounding soils.
- There should be at least four feet between the bottom of the trench and the seasonal high ground water table.
- A silt trap or similar device may be installed upstream of the perforated pipe if pretreatment is needed prior to discharge.
- The bottom of the trench should be filled with at least 18 inches of medium sand meeting TxDOT Fine Aggregate Grade No 1 and covered with a layer of filter fabric.
- A minimum of six inches of ¾" – 2 ½" round or crushed rock shall be placed on top of the fabric covered sand base.
- Piping should be 3" diameter prior to the perforated drainage pipe, 4" if serving greater than 1500 square feet of roof.
- The perforated pipe shall be an approved leach field pipe with holes oriented downward. It shall be covered with filter fabric, with at least 12" of backfill above the pipe.

21.4 Inspection and Maintenance Requirements

The inspection and maintenance requirements for soakage trenches are designed to maintain an adequate drainage rate through the trench, avoiding flooding.

Activity	Schedule
<ul style="list-style-type: none">• Ensure that inflow is unimpeded.	Quarterly and within 48 hours of major storms
<ul style="list-style-type: none">• Clean silt trap if it is more than 25% full of sediment	As needed, based on minimum annual inspection
<ul style="list-style-type: none">• Inspect trench for waterlogged soils at surface.	Between 24 - 48 hours after major storms

21.5 Example Schematics

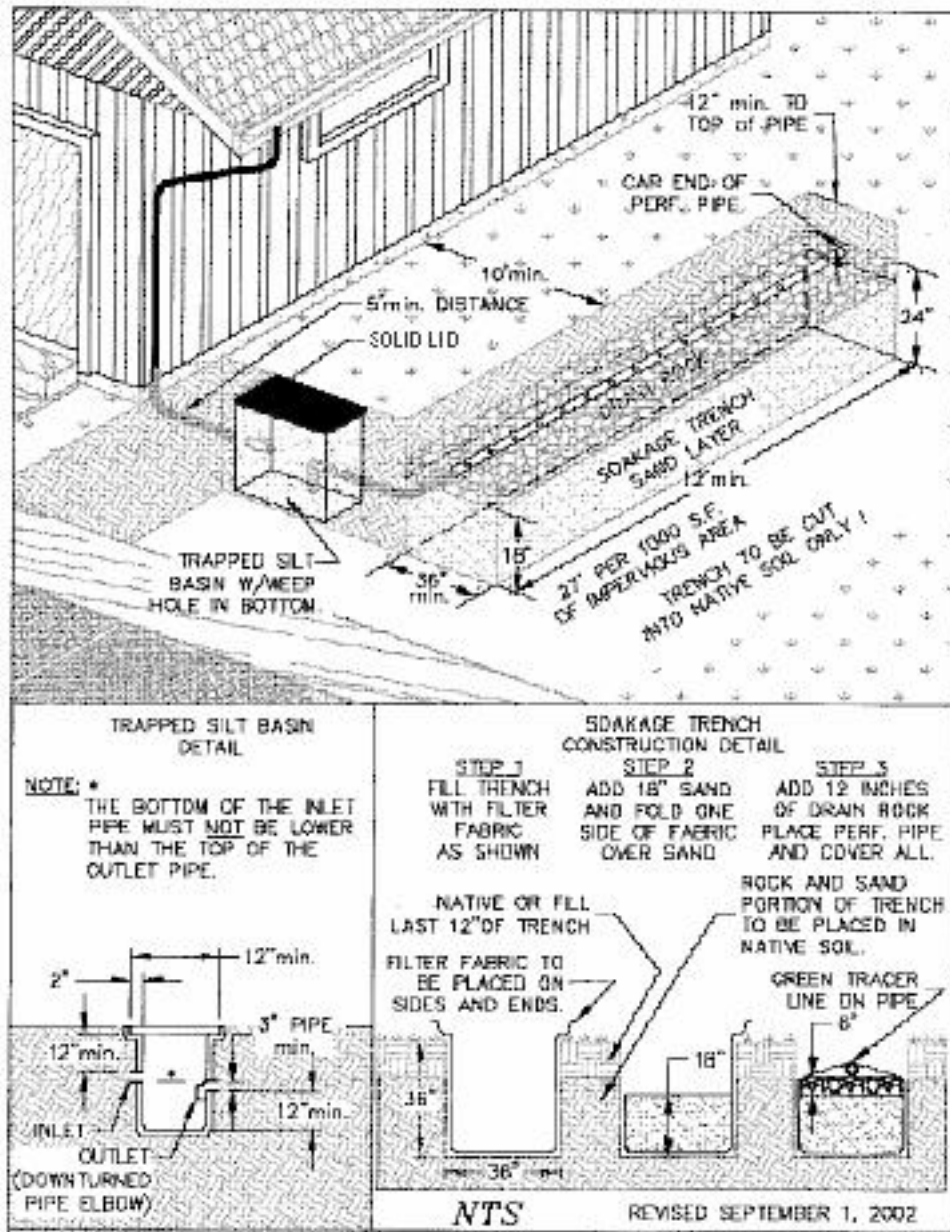

Figure 21.1 Schematic of a Soakage Trench
(Source: City of Portland, Oregon)

22.0 Stormwater Ponds

Stormwater Control



Description: Constructed stormwater retention basin that has a permanent pool (or micropool). Runoff from each rain event is detained and treated in the pool primarily through settling and biological uptake mechanisms.

KEY CONSIDERATIONS

DESIGN CRITERIA:

- Minimum contributing drainage area of 25 acres; 10 acres for extended detention micropool pond
- A sediment forebay or equivalent upstream pretreatment must be provided
- Minimum length to width ratio for the pond is 1.5:1
- Maximum depth of the permanent pool should not exceed 8 feet
- Vegetated side slopes to the pond should not exceed 3:1 (h:v)

ADVANTAGES / BENEFITS:

- Moderate to high removal rate of urban pollutants
- High community acceptance
- Opportunity for wildlife habitat

DISADVANTAGES / LIMITATIONS:

- Potential for thermal impacts/downstream warming
- Dam height restrictions for high relief areas
- Pond drainage can be problematic for low relief terrain

MAINTENANCE REQUIREMENTS:

- Remove debris from inlet and outlet structures
- Maintain side slopes / remove invasive vegetation
- Monitor sediment accumulation and remove periodically
- Dam inspection and maintenance

POLLUTANT REMOVAL

80%	Total Suspended Solids
50/30%	Nutrients - Total Phosphorus / Total Nitrogen removal
50%	Metals - Cadmium, Copper, Lead, and Zinc removal
70%	Pathogens - Coliform, Streptococci, E.Coli removal

STORMWATER MANAGEMENT SUITABILITY

- P** Water Quality Protection
- P** Streambank Protection
- P** On-Site Flood Control
- P** Downstream Flood Control

IMPLEMENTATION CONSIDERATIONS

- L** Land Requirement
- L** Capital Cost
- L** Maintenance Burden

Residential Subdivision Use: Yes

High Density/Ultra-Urban: No

Drainage Area: 10-25 acres min.

Soils: Hydrologic group 'A' and 'B' soils may require pond liner

Other Considerations:

- Outlet Clogging
- Safety Bench
- Landscaping
- Hotspot areas

L=Low M=Moderate H=High

22.1 General Description

Stormwater ponds (also referred to as *retention ponds*, *wet ponds*, or *wet extended detention ponds*) are constructed stormwater retention basins that have a permanent (dead storage) pool of water throughout the year. They can be created by excavating an already existing natural depression or through the construction of embankments.

In a stormwater pond, runoff from each rain event is detained and treated in the pool through gravitational settling and biological uptake until it is displaced by runoff from the next storm. The permanent pool also serves to protect deposited sediments from resuspension. Above the permanent pool level, additional temporary storage (live storage) is provided for runoff quantity control. The upper stages of a stormwater pond are designed to provide extended detention of the 1-year storm for downstream streambank protection, as well as normal detention of larger storm events to meet Q_f requirements.

Stormwater ponds are among the most cost-effective and widely used stormwater practices. A well-designed and landscaped pond can be an aesthetic feature on a development site when planned and located properly.

There are several different variants of stormwater pond design, the most common of which include the wet pond, the wet extended detention pond, and the micropool extended detention pond. In addition, multiple stormwater ponds can be placed in series or parallel to increase performance or meet site design constraints. Below are descriptions of each design variant:

- **Wet Pond** – Wet ponds are stormwater basins constructed with a permanent (dead storage) pool of water equal to the water quality volume. Stormwater runoff displaces the water already present in the pool. Temporary storage (live storage) can be provided above the permanent pool elevation for larger flows.
- **Wet Extended Detention (ED) Pond** – A wet extended detention pond is a wet pond where the water quality volume is split evenly between the permanent pool and extended detention (ED) storage provided above the permanent pool. During storm events, water is detained above the permanent pool and released over 24 hours. This design has similar pollutant removal to a traditional wet pond, but consumes less space.
- **Micropool Extended Detention (ED) Pond** – The micropool extended detention pond is a variation of the extended detention wet pond where only a small “micropool” is maintained at the outlet to the pond. The outlet structure is sized to detain the water quality volume for 24 hours. The micropool prevents resuspension of previously settled sediments and also prevents clogging of the low flow orifice.
- **Multiple Pond Systems** – Multiple pond systems consist of constructed facilities that provide water quality and quantity volume storage in two or more cells. The additional cells can create longer pollutant removal pathways and improved downstream protection.

Figure 22.1 shows a number of examples of stormwater pond variants. [Section 22.8](#) provides plan view and profile schematics for the design of a wet pond, wet extended detention pond, micropool extended detention pond, and multiple pond system.



Conventional dry detention basins do not provide a permanent pool and are **not recommended** for general application use to meet water quality criteria, as they fail to demonstrate an ability to meet the majority of the water quality goals. In addition, dry detention basins are prone to clogging and resuspension of previously settled solids and require a higher frequency of maintenance than wet ponds if used for untreated stormwater flows. These facilities can be used in combination with appropriate water quality controls to provide streambank protection, and overbank and extreme flood storage. Please see a further discussion in [Section 10.0](#) on Dry Detention Basins).



Figure 22.1 Stormwater Pond Examples

22.2 Stormwater Management Suitability

Stormwater ponds are designed to control both stormwater quantity and quality. Thus, a stormwater pond can be used to address all of the *integrated stormwater sizing criteria* for a given drainage area.

Water Quality

Ponds treat incoming stormwater runoff by physical, biological, and chemical processes. The primary removal mechanism is gravitational settling of particulates, organic matter, metals, bacteria, and organics as stormwater runoff resides in the pond. Another mechanism for pollutant removal is uptake by algae and wetland plants in the permanent pool – particularly of nutrients. Volatilization and chemical activity also work to break down and eliminate a number of other stormwater contaminants such as hydrocarbons.

[Section 22.3](#) provides pollutant removal efficiencies that can be used for planning and design purposes.

Streambank Protection

A portion of the storage volume above the permanent pool in a stormwater pond can be used to provide control of the streambank protection volume (SP_v). This is accomplished by releasing the 1-year, 24-hour storm runoff volume over 24 hours (extended detention).

On-Site Flood Control

A stormwater pond can also provide detention storage above the permanent pool to reduce the post-development peak flow to pre-development levels, if required.

Downstream Flood Control

In situations where it is required, stormwater ponds can also be used to provide detention to control the flood mitigation storm peak flow downstream. Where this is not required, the pond structure is designed to safely pass extreme storm flows.

22.3 Pollutant Removal Capabilities

All of the stormwater pond design variants are presumed to be able to remove 80% of the total suspended solids load in typical urban post-development runoff when sized, designed, constructed and maintained in accordance with the recommended specifications. Undersized or poorly designed ponds can reduce TSS removal performance.

The following design pollutant removal rates are conservative average pollutant reduction percentages for design purposes derived from sampling data, modeling and professional judgment. In a situation where a removal rate is not deemed sufficient, additional controls may be put in place at the given site in a series or “treatment train” approach.

- Total Suspended Solids – 80%
- Total Phosphorus – 50%
- Total Nitrogen – 30%
- Fecal Coliform – 70% (if no resident waterfowl population present)
- Heavy Metals – 50%

For additional information and data on pollutant removal capabilities for stormwater ponds, see the National Pollutant Removal Performance Database (2nd Edition) available at www.cwp.org and the National Stormwater Best Management Practices (BMP) Database at www.bmpdatabase.org

22.4 Application and Site Feasibility Criteria

Stormwater ponds are generally applicable to most types of new development and redevelopment, and can be used in both residential and nonresidential areas. Ponds can also be used in retrofit situations. The following criteria should be evaluated to ensure the suitability of a stormwater pond for meeting stormwater management objectives on a site or development.

General Feasibility

- Suitable for Residential Subdivision Usage – YES
- Suitable for High Density/Ultra-Urban Areas – Land requirements may preclude use
- Regional Stormwater Control – YES
- Hotspot Runoff - YES

Physical Feasibility - Physical Constraints at Project Site

Drainage Area – A minimum of 25 acres is needed for wet pond and extended detention wet pond to maintain a permanent pool, 10 acres minimum for extended detention micropool pond. A smaller drainage area may be acceptable with an adequate water balance and anti-clogging device.

Space Required – Approximately 2 to 3% of the tributary drainage area

Site Slope – There should not be more than 15% slope across the pond site.

Minimum Head – Elevation difference needed at a site from the inflow to the outflow: 6 to 8 feet

Minimum Depth to Water Table – If used on a site with an underlying water supply aquifer or when treating a hotspot, a separation distance of 2 feet is required between the bottom of the pond and the elevation of the seasonally high water table.

Soils – Underlying soils of hydrologic group “C” or “D” should be adequate to maintain a permanent pool. Most group “A” soils and some group “B” soils will require a pond liner. *Evaluation of soils should be based upon an actual subsurface analysis and permeability tests.*

Other Constraints / Considerations

- **Local Aquatic Habitat** – Consideration should be given to the thermal influence of stormwater pond outflows on downstream local aquatic habitats.

22.5 Planning and Design Criteria

*The following criteria are to be considered **minimum** standards for the design of a stormwater pond facility. Consult with the local review authority to determine if there are any variations to these criteria or additional standards that must be followed.*

A Location and Siting

Stormwater ponds should have a minimum contributing drainage area of 25 acres or more for wet pond or extended detention wet pond to maintain a permanent pool. For an extended detention micropool pond, the minimum drainage area is 10 acres. A smaller drainage area can be considered when water availability can be confirmed (such as from a groundwater source or areas with a high water table). In these cases a water balance may be performed (see [Section 4.0 of the Hydrology Technical Manual](#) for details). Ensure that an appropriate anti-clogging device is provided for the pond outlet.

A stormwater pond should be sited such that the topography allows for maximum runoff storage at minimum excavation or construction costs. Pond siting should also take into account the location and use of other site features such as buffers and undisturbed natural areas and should attempt to aesthetically “fit” the facility into the landscape. Bedrock close to the surface may prevent excavation.

Stormwater ponds should not be located on steep (>15%) or unstable slopes.

Stormwater ponds cannot be located within a stream or any other navigable waters of the U.S., including wetlands, without obtaining a Section 404 permit under the Clean Water Act, and any other applicable State permit.

Minimum setback requirements for stormwater pond facilities measured from the easement line that defines the pond site (when not specified by local ordinance or criteria):

- From a property line – 10 feet
- From a private well – 100 feet; if well is downgradient from a hotspot land use then the minimum setback is 250 feet
- From a septic system tank/leach field/spray area – 50 feet

All utilities should be located outside of the pond/basin site.

B General Design

A well-designed stormwater pond consists of:

1. Permanent pool of water,
2. Overlying zone in which runoff control volumes are stored, and
3. Shallow littoral zone (aquatic bench) along the edge of the permanent pool that acts as a biological filter.

In addition, all stormwater pond designs need to include a sediment forebay at all major inflows to the basin to allow heavier sediments to drop out of suspension before the runoff enters the permanent pool. (A sediment forebay schematic can be found in [iSWM Program Guidance – Federal, State and Regional Initiatives](#))

Additional pond design features include an emergency spillway, maintenance access, safety bench, pond buffer, and appropriate native landscaping.

Figures 22.4 thru 22.7 in [Section 22.8](#) provide plan view and profile schematics for the design of a wet pond, extended detention wet pond, extended detention micropool pond and multiple pond system.

C Physical Specifications / Geometry

In general, pond designs are unique for each site and application. However, there are number of geometric ratios and limiting depths for pond design that must be observed for adequate pollutant removal, ease of maintenance, and improved safety.

Permanent pool volume is typically sized as follows:

- Standard wet ponds: 100% of the water quality treatment volume (1.0 WQ_v)
- Extended detention wet ponds: 50% of the water quality treatment volume (0.5 WQ_v)
- extended detention micropool ponds: Approximately 0.1 inch per impervious acre

Proper geometric design is essential to prevent hydraulic short-circuiting (unequal distribution of inflow), which results in the failure of the pond to achieve adequate levels of pollutant removal. The minimum length-to-width ratio for the permanent pool shape is 1.5:1, and should ideally be greater than 3:1 to avoid short-circuiting. In addition, ponds should be wedge-shaped when possible so that flow enters the pond and gradually spreads out, improving the sedimentation process. Baffles, pond shaping or islands can be added within the permanent pool to increase the flow path.

Maximum depth of the permanent pool should generally not exceed 8 feet to avoid stratification and anoxic conditions. Minimum depth for the pond bottom should be 3 to 4 feet. Deeper depths near the outlet will yield cooler bottom water discharges that may mitigate downstream thermal effects.

Side slopes to the pond should not usually exceed 3:1 (h:v) without safety precautions or if mowing is anticipated and should terminate on a safety bench (see Figure 22.2). The safety bench requirement may be waived if slopes are 4:1 or gentler. All side slopes should be verified with a geotechnical evaluation to ensure slope stability.

The perimeter of all deep pool areas (4 feet or greater in depth) should be surrounded by two benches: safety and aquatic. For larger ponds, a safety bench extends approximately 15 feet outward from the normal water edge to the toe of the pond side slope. The maximum slope of the safety bench should be 6%. An aquatic bench extends inward from the normal pool edge (15 feet on average) and has a maximum depth of 18 inches below the normal pool water surface elevation (see Figure 22.2).

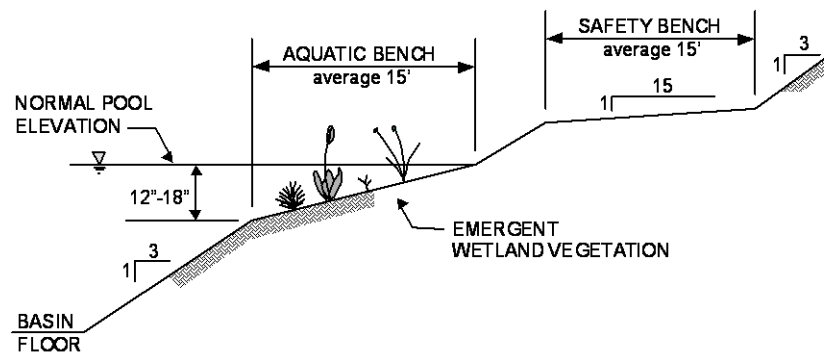

Figure 22.2 Typical Stormwater Pond Geometry Criteria

The contours and shape of the permanent pool should be irregular to provide a more natural landscaping effect.

D Pretreatment / Inlets

Each pond should have a sediment forebay or equivalent upstream pretreatment. A sediment forebay is designed to remove incoming sediment from the stormwater flow prior to dispersal in a larger permanent pool. The forebay should consist of a separate cell, formed by an acceptable barrier. A forebay is to be provided at each inlet, unless the inlet provides less than 10% of the total design storm inflow to the pond. In some design configurations, the pretreatment volume may be located within the permanent pool.

The forebay is sized to contain 0.1 inches per impervious acre of contributing drainage and should be 4 to 6 feet deep. The pretreatment storage volume is part of the total WQ_v requirement and may be subtracted from WQ_v for permanent pool sizing.

A fixed vertical sediment depth marker shall be installed in the forebay to measure sediment deposition over time. The bottom of the forebay may be hardened (e.g., using concrete, paver blocks, etc.) to make sediment removal easier.

Inflow channels are to be stabilized with flared riprap aprons, or the equivalent. Inlet pipes to the pond can be partially submerged. Inflow pipe, channel velocities, and exit velocities from the forebay must be nonerosive.

E Outlet Structures

Flow control from a stormwater pond is typically accomplished with the use of a concrete or corrugated aluminum, aluminized steel, or HDPE riser and barrel. The riser is a vertical pipe or inlet structure that is attached to the bottom of the pond with a watertight connection. The outlet barrel is a horizontal pipe attached to the riser that conveys flow under the embankment (see Figure 22.3). The riser should be located within the embankment for maintenance access, safety and aesthetics.

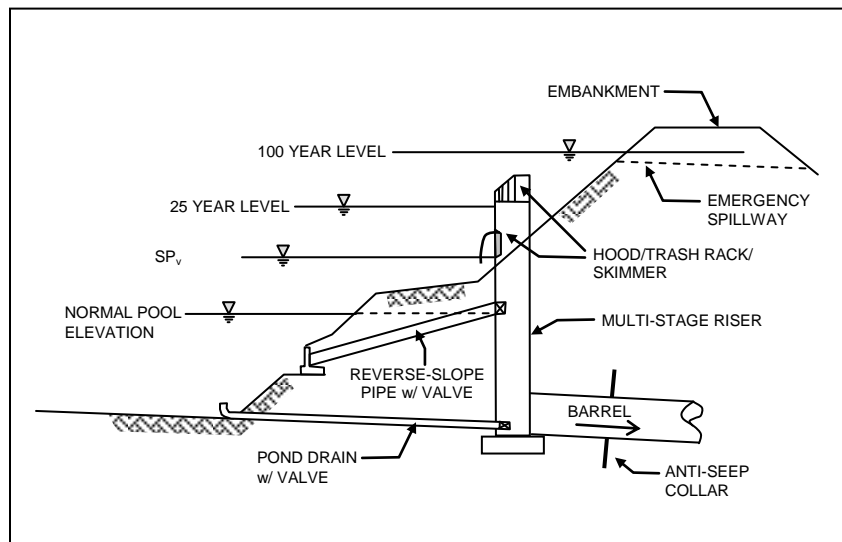

Figure 22.3 Typical Pond Outlet Structure

A number of outlets at varying depths in the riser provide internal flow control for routing of the water quality, streambank protection, and on-site flood control runoff volumes. The number of orifices can vary and is usually a function of the pond design.

Embankments 6 feet in height or greater shall be designed per Texas Commission on Environmental Quality guidelines for Dam Safety. See *iSWM Program Guidance – Dams and Reservoirs in Texas*.

For example, a wet pond riser configuration is typically comprised of a streambank protection outlet (usually an orifice) and on-site flood control outlet (often a slot or weir). The streambank protection orifice is sized to release the streambank protection storage volume over a 24-hour period (12-hour extended

detention may be warranted in some cold water streams). Since the water quality volume is fully contained in the permanent pool, no orifice sizing is necessary for this volume. As runoff from a water quality event enters the wet pond, it simply displaces that same volume through the streambank protection orifice. Thus an off-line wet pond providing only water quality treatment can use a simple overflow weir as the outlet structure.

In the case of an extended detention wet pond or extended detention micropool pond, there is generally a need for an additional outlet (usually an orifice) that is sized to pass the extended detention water quality volume that is surcharged on top of the permanent pool. Flow will first pass through this orifice, which is sized to release the water quality extended detention volume in 24 hours. The preferred design is a reverse slope pipe attached to the riser, with its inlet submerged 1 foot below the elevation of the permanent pool to prevent floatables from clogging the pipe and to avoid discharging warmer water at the surface of the pond. The next outlet is sized for the release of the streambank protection storage volume. The outlet (often an orifice) invert is located at the maximum elevation associated with the extended detention water quality volume and is sized to release the streambank protection storage volume over a 24-hour period.

Alternative hydraulic control methods to an orifice can be used and include the use of a broad-crested rectangular, V-notch, proportional weir, or an outlet pipe protected by a hood that extends at least 12 inches below the normal pool.

The water quality outlet (if design is for an extended detention wet or extended detention micropool pond) and streambank protection outlet should be fitted with adjustable gate valves or other mechanism that can be used to adjust detention time.

Higher flows (On-Site and Downstream Flood Control) pass through openings or slots protected by trash racks further up on the riser.

After entering the riser, flow is conveyed through the barrel and is discharged downstream. Anti-seep collars should be installed on the outlet barrel to reduce the potential for pipe failure.

Riprap, plunge pools, or pads, or other energy dissipators are to be placed at the outlet of the barrel to prevent scouring and erosion. If a pond daylights to a channel with dry weather flow, care should be taken to minimize tree clearing along the downstream channel, and to reestablish a forested riparian zone in the shortest possible distance. See [Section 4.0 of the Hydraulics Technical Manual](#) for more guidance.

Each pond must have a bottom drain pipe with an adjustable valve that can completely or partially drain the pond within 24 hours.

The pond drain should be sized one pipe size greater than the calculated design diameter. The drain valve is typically a handwheel activated knife or gate valve. Valve controls shall be located inside of the riser at a point where they (a) will not normally be inundated and (b) can be operated in a safe manner.

See the design procedures in [Section 22.6](#) as well as [Sections 2.0 and 2.2 of the Hydraulics Technical Manual](#) for additional information and specifications on pond routing and outlet works.

F Emergency Spillway

An emergency spillway is to be included in the stormwater pond design to safely pass the extreme flood flow. The spillway prevents pond water levels from overtopping the embankment and causing structural damage. The emergency spillway must be located so that downstream structures will not be impacted by spillway discharges. All local and state dam safety requirements should be met.

A minimum of 1 foot of freeboard must be provided, measured from the top of the water surface elevation for the extreme flood to the lowest point of the dam embankment, not counting the emergency spillway.

G Maintenance Access

A maintenance right of way or easement must be provided to a pond from a public road or easement. Maintenance access should be at least 12 feet wide, have a maximum slope of no more than 15%, and be appropriately stabilized to withstand maintenance equipment and vehicles.

The maintenance access must extend to the forebay, safety bench, riser, and outlet and, to the extent feasible, be designed to allow vehicles to turn around.

Access to the riser is to be provided by lockable manhole covers, and manhole steps should be within easy reach of valves and other controls.

H Safety Features

All embankments and spillways must be designed to State of Texas guidelines for dam safety (see *iSWM Program Guidance – Dams and Reservoirs in Texas*).

Fencing of ponds is not generally desirable, but may be required by the local review authority. A preferred method is to manage the contours of the pond through the inclusion of a safety bench (see above) to eliminate dropoffs and reduce the potential for accidental drowning. In addition, the safety bench may be landscaped to deter access to the pool.

The principal spillway opening should not permit access by small children, and endwalls above pipe outfalls greater than 48 inches in diameter should be fenced to prevent access. Warning signs should be posted near the pond to prohibit swimming and fishing in the facility.

I Landscaping

- Aquatic vegetation can play an important role in pollutant removal in a stormwater pond. In addition, vegetation can enhance the appearance of the pond, stabilize side slopes, serve as wildlife habitat, and can temporarily conceal unsightly trash and debris. Therefore, wetland plants should be encouraged in a pond design, along the aquatic bench (fringe wetlands), the safety bench and side slopes (ED ponds), and within shallow areas of the pool itself. The best elevations for establishing wetland plants, either through transplantation or volunteer colonization, are within 6 inches (plus or minus) of the normal pool elevation. Additional information on establishing wetland vegetation and appropriate wetland species for North Central Texas can be found in the *Landscape Technical Manual*.
- Woody vegetation may not be planted on the embankment or allowed to grow within 15 feet of the toe of the embankment and 25 feet from the principal spillway structure.
- A pond buffer should be provided that extends 25 feet outward from the maximum water surface elevation of the pond. The pond buffer should be contiguous with other buffer areas that are required by existing regulations (e.g., stream buffers) or that are part of the overall stormwater management concept plan. No structures should be located within the buffer, and an additional setback to permanent structures may be provided.
- Existing trees should be preserved in the buffer area during construction. It is desirable to locate forest conservation areas adjacent to ponds. To discourage resident geese populations, the buffer can be planted with trees, shrubs and native ground covers.
- The soils of a pond buffer are often severely compacted during the construction process to ensure stability. The density of these compacted soils is so great that it effectively prevents root penetration and therefore may lead to premature mortality or loss of vigor. Consequently, it is advisable to excavate large and deep holes around the proposed planting sites and backfill these with uncompacted topsoil.
- Fish such as *Gambusia affinis* can be stocked in a pond to aid in mosquito prevention.
- A fountain or solar-powered aerator may be used for oxygenation of water in the permanent pool.
- Compatible multi-objective use of stormwater pond locations is strongly encouraged.

J Additional Site-Specific Design Criteria and Issues

Physiographic Factors - Local terrain design constraints

- Low Relief – Maximum normal pool depth is limited; providing pond drain can be problematic

- High Relief – Embankment heights restricted
- Karst – Requires poly or clay liner to sustain a permanent pool of water and protect aquifers; limits on ponding depth; geotechnical tests may be required

Soils

- Hydrologic group “A” soils generally require pond liner; group “B” soils may require infiltration testing

Special Downstream Watershed Considerations

- Local Aquatic Habitat – extended detention micropool pond best alternative; design wet ponds and extended detention wet ponds offline and provide shading to minimize thermal impact; limit WQ_v -ED to 12 hours
- Aquifer Protection – Reduce potential groundwater contamination by preventing infiltration of hotspot runoff. May require liner for type “A” and “B” soils; pretreat hotspots; 2 to 4 foot separation distance from water table
- Swimming Area/Shellfish – Design for geese prevention (see the *Landscape Technical Manual*); provide 48-hour extended detention for maximum coliform dieoff.

Dams

Dam construction for stormwater ponds can take a variety of forms. Large dams that are over six feet in height are regulated by the State of Texas (See *iSWM Program Guidance – Dams and Reservoirs in Texas*). Small dams are not as tightly regulated, but require careful attention to design and construction details to ensure that they function properly throughout their designed economic life.

The most commonly used material for small dam construction is earth fill, but structural concrete can also be used. For on-site stormwater controls in high density areas of development or where land values are very costly, the use of a structural concrete dam can save significant amounts of land while making a much more aesthetically appealing outfall structure than the typical riser and barrel assembly.

General

- The dam area shall be cleared, grubbed and stripped of all vegetative material and topsoil prior to dam construction.

Earth Dams

- The dam construction plans shall indicate allowable soil materials to be used, compaction required, locations of core trenches if used, any sub-drainage facilities to be installed to control seepage, plus horizontal and vertical dimensions of the earthen structure.
- The sub-grade of the dam shall be scarified prior to the placement and compaction of the first lift of soil backfill to ensure a good bond between the existing soil and the earthen dam.
- Placement of earth fill shall be in controlled lifts with proper compaction.
- Placement of spillway or outflow pipes through the dam shall be per the plan details, with proper backfill and compaction of any excavated trenches. Hydraulic flooding or other compaction methods of saturated soil shall not be allowed.
- Topsoil and soil additives necessary for the establishment of permanent ground cover above the normal water surface elevation and on the downstream side of the dam shall be installed and seeded as soon as practical to avoid rilling and erosion of the dam’s earthen embankment.
- Do not plant trees or large shrubs on the earth dam, as their root systems cause seepage and damage to the structure.

Concrete Dams

- Concrete dams shall be designed and built in accordance with the American Concrete Institute's (ACI) latest guidelines for Environmental Engineering Concrete Structures. Particular attention shall be paid to water tightness, crack control, concrete materials and construction practices.
- The construction plans shall indicate materials, plus horizontal and vertical dimensions necessary for the construction of the dam. Details and information shall be provided on joint types and spacing to be used.
- At least one-half of the water surface perimeter of the pond at normal pool elevation shall be constructed with a vegetated earthen embankment.
- Principal and emergency spillways can be incorporated into a weir overflow over the dam if splash pads or another type of control structure is provided to protect the downstream toe of the concrete structure.
- Placement of drain valves, overflow controls and other penetrations of the concrete wall shall not be located on the same vertical line to prevent creating a weakened plane where uncontrolled cracks can form. Locations should also anticipate operation during storm events when overflow weirs will be operating.

22.6 Design Procedures

Step 1 Compute runoff control volumes from the *integrated* Design Focus Areas

Calculate the Water Quality Volume (WQ_v), Streambank Protection Volume (SP_v), and the Flood Protection Storm (Q_f). Design volume should be increased by 15% for extended detention ponds.

Details on the *integrated* Design Focus Areas are found in [Section 1.0 of the Planning Technical Manual](#).

Step 2 Determine if the development site and conditions are appropriate for the use of a stormwater pond

Consider the Application and Site Feasibility Criteria in [Sections 22.4 and 22.5 \(A\)](#) (Location and Siting).

Step 3 Confirm local design criteria and applicability

Consider any special site-specific design conditions/criteria from [Section 22.5 \(J\)](#). (Additional Site-Specific Design Criteria and Issues).

Check with local officials and other agencies to determine if there are any additional restrictions and/or surface water or watershed requirements that may apply.

Step 4 Determine pretreatment volume

A sediment forebay is provided at each inlet, unless the inlet provides less than 10% of the total design storm inflow to the pond. The forebay should be sized to contain 0.1 inches per impervious acre of contributing drainage and should be 4 to 6 feet deep. The forebay storage volume counts toward the total WQ_v requirement and may be subtracted from the WQ_v for subsequent calculations.

Step 5 Determine permanent pool volume (and water quality extended detention volume)

Wet Pond: Size permanent pool volume to $1.0 WQ_v$

Extended Detention Wet Pond: Size permanent pool volume to $0.5 WQ_v$. Size extended detention volume to $0.5 WQ_v$.

Extended Detention Micropool Pond: Size permanent pool volume to 25 to 30% of WQ_v . Size extended detention volume to remainder of WQ_v .

- Step 6 Determine pond location and preliminary geometry. Conduct pond grading and determine storage available for permanent pool (and water quality extended detention if extended detention wet pond or extended detention micropool pond)

This step involves initially grading the pond (establishing contours) and determining the elevation-storage relationship for the pond.

- Include safety and aquatic benches.
- Set WQ_v permanent pool elevation (and WQ_v -ED elevation for extended detention wet and extended detention micropool pond) based on volumes calculated earlier.

See [Section 22.5 \(C\)](#) (Physical Specifications / Geometry) for more details.

- Step 7 Compute extended detention orifice release rate(s) and size(s), and establish SP_v elevation

Wet Pond: The SP_v elevation is determined from the stage-storage relationship and the orifice is then sized to release the streambank protection storage volume over a 24-hour period (12-hour extended detention may be warranted in some cold water streams). The streambank protection orifice should have a minimum diameter of 3 inches and should be adequately protected from clogging by an acceptable external trash rack. A reverse slope pipe attached to the riser, with its inlet submerged 1 foot below the elevation of the permanent pool, is a recommended design. The orifice diameter may be reduced to 1 inch if internal orifice protection is used (i.e., an over-perforated vertical stand pipe with ½-inch orifices or slots that are protected by wirecloth and a stone filtering jacket). Adjustable gate valves can also be used to achieve this equivalent diameter.

Extended Detention Wet Pond and Extended Detention Micropool Pond: Based on the elevations established in Step 6 for the extended detention portion of the water quality volume, the water quality orifice is sized to release this extended detention volume in 24 hours. The water quality orifice should have a minimum diameter of 3 inches and should be adequately protected from clogging by an acceptable external trash rack. A reverse slope pipe attached to the riser, with its inlet submerged 1 foot below the elevation of the permanent pool, is a recommended design. Adjustable gate valves can also be used to achieve this equivalent diameter. The SP_v elevation is then determined from the stage-storage relationship. The invert of the streambank protection orifice is located at the water quality extended detention elevation, and the orifice is sized to release the streambank protection storage volume over a 24-hour period (12-hour extended detention may be warranted in some cold water streams).

- Step 8 Calculate Q_p release rate and water surface elevation

Set up a stage-storage-discharge relationship for the control structure for the extended detention orifice(s) and the design storm.

- Step 9 Design embankment(s) and spillway(s)

Size emergency spillway, calculate flood mitigation stormwater surface elevation, set top of embankment elevation, and analyze safe passage of the flood mitigation storm.

At final design, provide safe passage for the flood mitigation storm event.

- Step 10 Investigate potential pond hazard classification

The design and construction of stormwater management ponds are required to follow the latest version of the State of Texas Administrative Code for and reservoirs (see [iSWM Program Guidance - Dams and Reservoirs in Texas](#)).

- Step 11 Design inlets, sediment forebay(s), outlet structures, maintenance access, and safety features.

See [Section 22.5 \(D\)](#) through (H) for more details.

- Step 12 Prepare Vegetation and Landscaping Plan

A landscaping plan for a stormwater pond and its buffer should be prepared to indicate how aquatic and terrestrial areas will be stabilized and established with vegetation.

See [Section 22.5 \(I\) \(Landscaping\)](#) and the [Landscape Technical Manual](#) for more details.

See [Section 29.2](#) for a Stormwater Pond Design Example

22.7 Inspection and Maintenance Requirements

Table 22.1 Typical Maintenance Activities for Ponds

(Source: WMI, 1997)

Activity	Schedule
<ul style="list-style-type: none"> • Clean and remove debris from inlet and outlet structures. • Mow side slopes. • Check visually for illegal dumping or other pollutants. 	Monthly
<ul style="list-style-type: none"> • If wetland components are included, inspect for invasive vegetation. 	Semiannual Inspection
<ul style="list-style-type: none"> • Inspect for damage, paying particular attention to the control structure. • Check for signs of eutrophic conditions. • Note signs of hydrocarbon build-up, and remove appropriately. • Monitor for sediment accumulation in the facility and forebay. • Examine to ensure that inlet and outlet devices are free of debris and operational. • Check all control gates, valves or other mechanical devices. • Check downstream face of dam for seepage (earth and concrete), settling (earth) and cracking (concrete). 	Annual Inspection
<ul style="list-style-type: none"> • Repair undercut or eroded areas. 	As Needed
<ul style="list-style-type: none"> • Perform wetland plant management and harvesting. 	Annually (if needed)
<ul style="list-style-type: none"> • Remove sediment from the forebay. 	5 to 7 years or after 50% of the total forebay capacity has been lost
<ul style="list-style-type: none"> • Monitor sediment accumulations, and remove sediment when the pool volume has become reduced significantly, or the pond becomes eutrophic. 	10 to 20 years or after 25% of the permanent pool volume has been lost

Additional Maintenance Considerations and Requirements

- A sediment marker should be located in the forebay to determine when sediment removal is required.
- Sediments excavated from stormwater ponds that do not receive runoff from designated hotspots are not considered toxic or hazardous material and can be safely disposed of by either land application or landfilling. Sediment testing may be required prior to sediment disposal when a hotspot land use is present.
- Periodic mowing of the pond buffer is only required along maintenance rights-of-way and the embankment. The remaining buffer can be managed as a meadow (mowing every other year) or forest.
- Care should be exercised during pond drawdowns to prevent downstream discharge of sediments, anoxic water, or high flows with erosive velocities. The approving jurisdiction should be notified before draining a stormwater pond.



Regular inspection and maintenance is critical to the effective operation of stormwater ponds as designed. Maintenance responsibility for a pond and its buffer should be vested with a responsible authority by means of a legally binding and enforceable maintenance agreement that is executed as a condition of plan approval.

22.8 Example Schematics

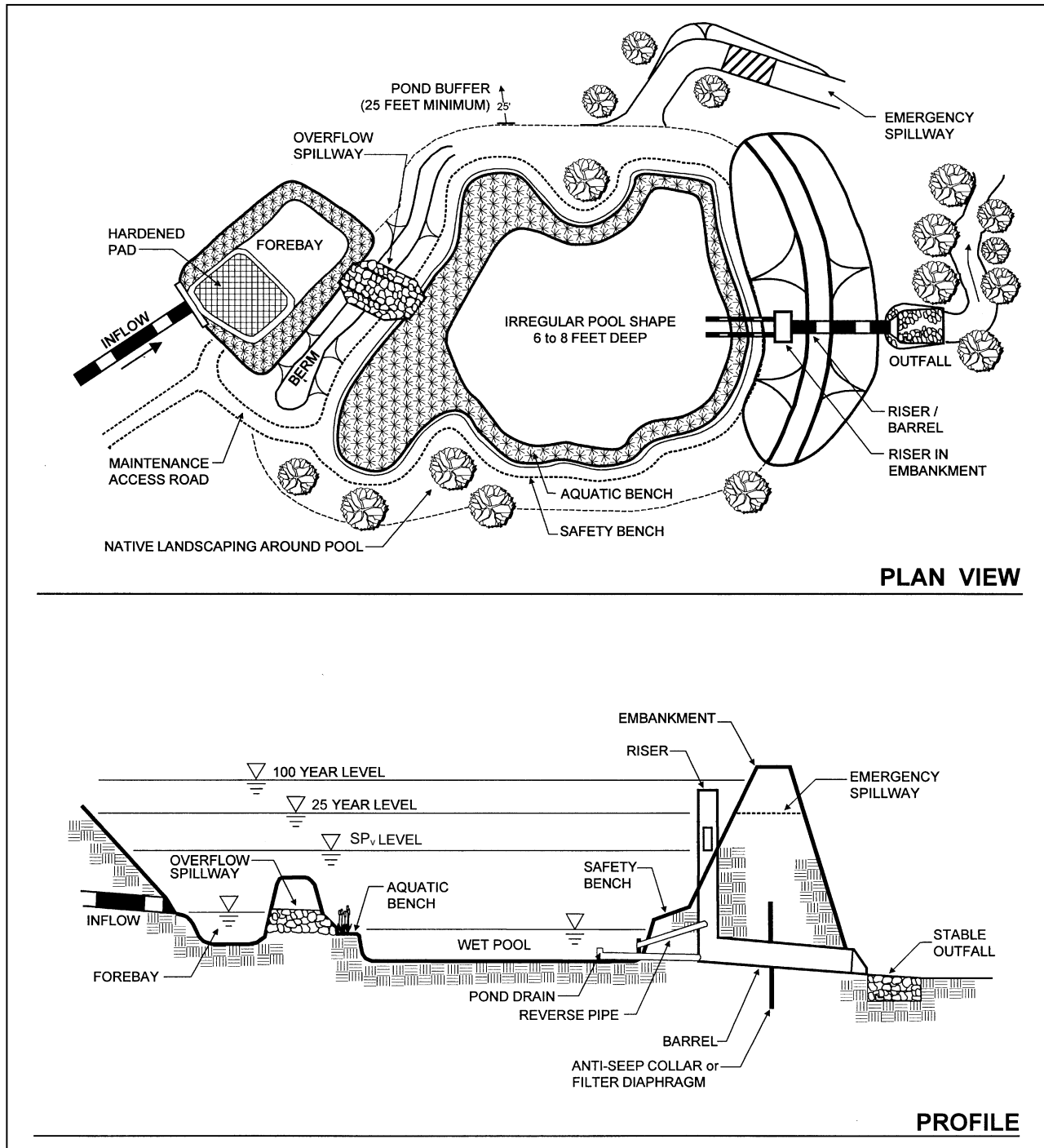

Figure 22.4 Schematic of Wet Pond
(Source: Center for Watershed Protection)

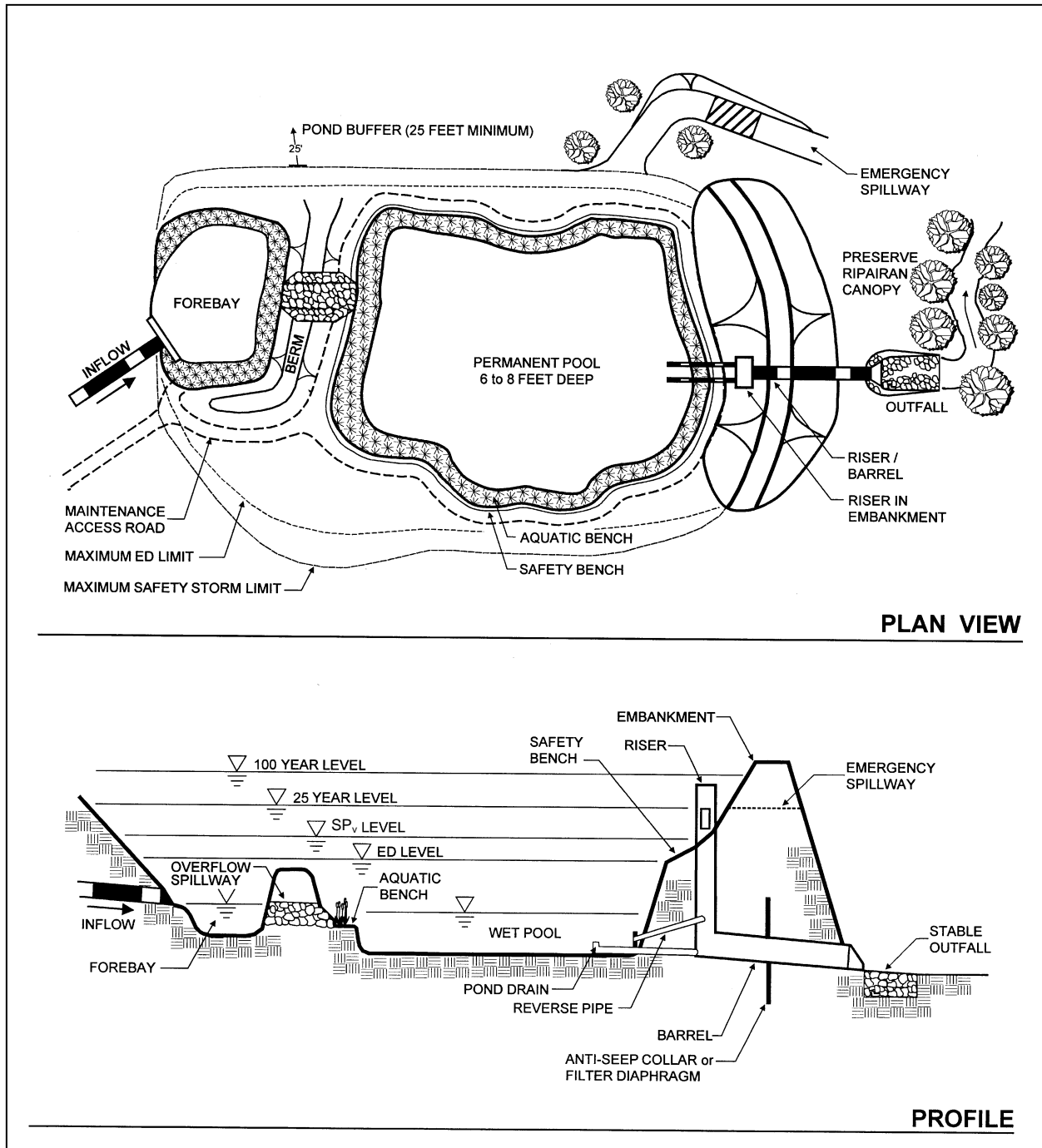

Figure 22.5 Schematic of Wet Extended Detention Pond
 (Source: Center for Watershed Protection)

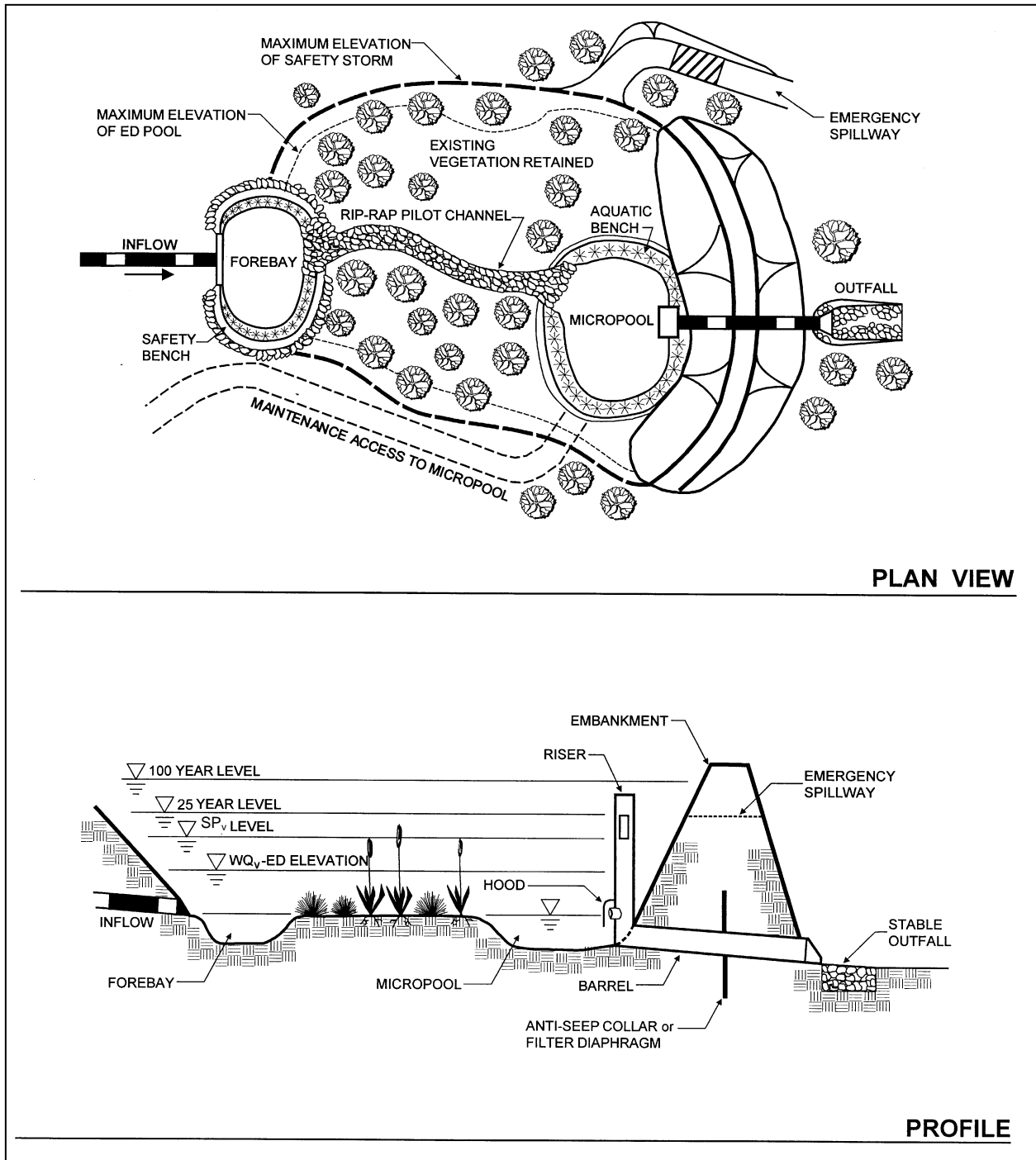

Figure 22.6 Schematic of Micropool Extended Detention Pond
 (Source: Center for Watershed Protection)

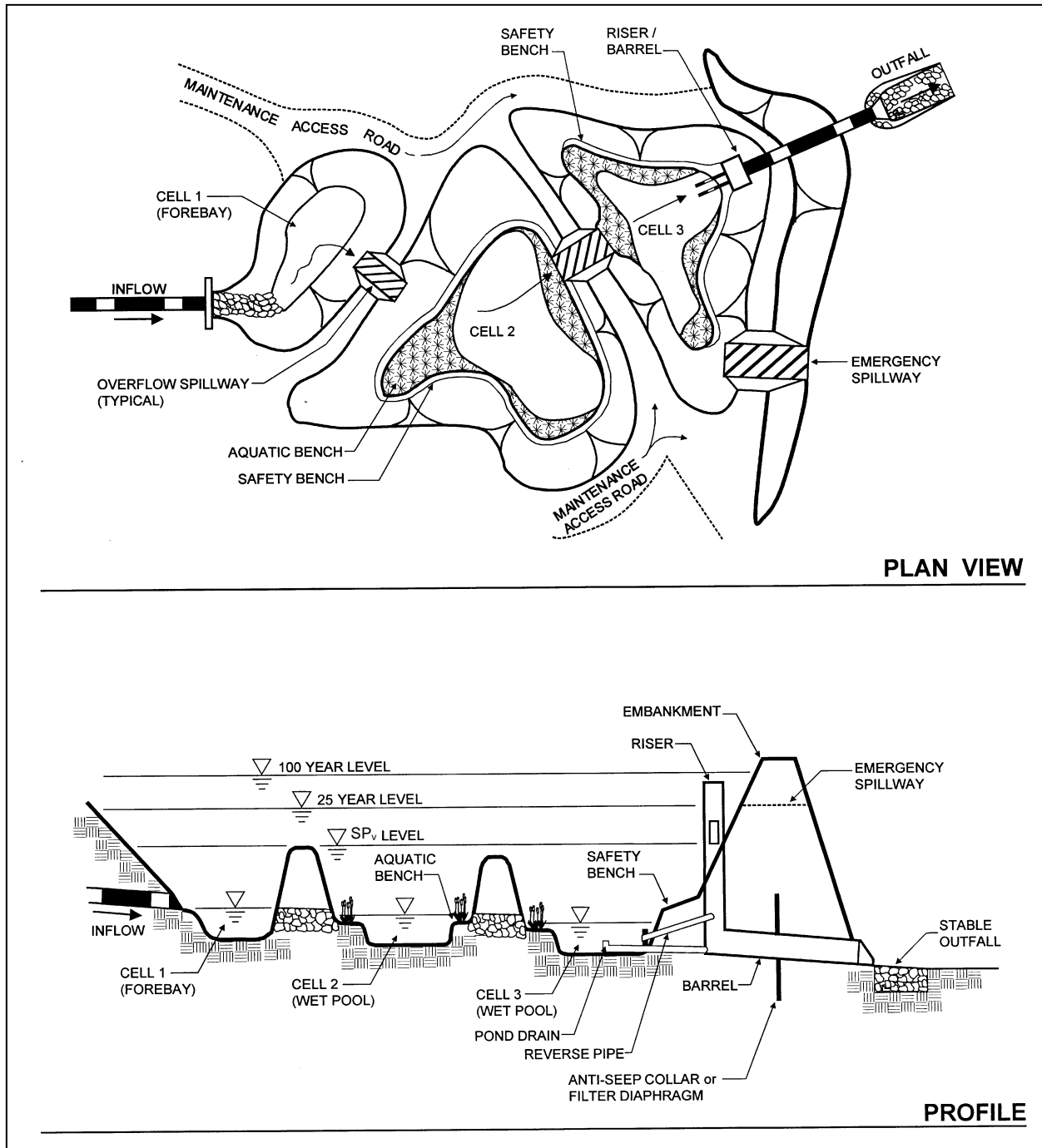

Figure 22.7 Schematic of Multiple Pond System
 (Source: Center for Watershed Protection)

22.9 Design Forms

Design Procedure Form: Storm Water Ponds

PRELIMINARY HYDROLOGIC CALCULATIONS

- 1a. Compute WQ_v Volume requirements
 Compute Runoff Coefficient, R_v
 Compute WQ_v Volume requirements
- 1b. Compute SP_v
 Compute average release rate
 Compute Q_p (Required 100-year detention volume)
 Add 15% to the required Q_p volume (if ED)
 Compute (as necessary) Q_f

$$R_v = \underline{\hspace{2cm}}$$

$$WQ_v = \underline{\hspace{2cm}} \text{ acre-ft}$$

$$SP_v = \underline{\hspace{2cm}} \text{ acre-ft}$$

$$\text{release rate} = \underline{\hspace{2cm}} \text{ cfs}$$

$$Q_p = \underline{\hspace{2cm}} \text{ acre-ft}$$

$$Q_p * 15\% = \underline{\hspace{2cm}} \text{ acre-ft}$$

$$Q_f = \underline{\hspace{2cm}} \text{ cfs}$$

STORM WATER POND DESIGN

- 2. Is the use of storm water pond appropriate?
- 3. Confirm local design criteria and applicability
- 4. Pretreatment volume
 $Vol_{pre} = I(0.1)(1/12)$
- 5. Allocation of Permanent Pool Volume and ED Volume
 Wet Pond: $Vol_{pool} = WQ_v$
 Wet ED Pond: $Vol_{pool} = 0.5(WQ_v)$
 $Vol_{ED} = 0.5(WQ_v)$
 Micropool ED Pond: $Vol_{pool} = 0.25(WQ_v)$
 $Vol_{ED} = 0.75(WQ_v)$
- 6. Conduct grading and determine storage available for permanent pool (and WQ_v -ED volume if applicable)

See subsection 5.2.21.4 and 5.2.21.5-A

$$Vol_{pre} = \underline{\hspace{2cm}} \text{ acre-ft}$$

$$Vol_{pool} = \underline{\hspace{2cm}} \text{ acre-ft}$$

$$Vol_{pool} = \underline{\hspace{2cm}} \text{ acre-ft}$$

$$Vol_{ED} = \underline{\hspace{2cm}} \text{ acre-ft}$$

$$Vol_{pool} = \underline{\hspace{2cm}} \text{ acre-ft}$$

$$Vol_{ED} = \underline{\hspace{2cm}} \text{ acre-ft}$$

Prepare an elevation-storage table and curve using the average area method for computing volumes.

Elevation	Area	Average Area	Depth	Volume	Cumulative Volume	Cumulative Volume	Volume above Permanent Pool
MSL	ft ²	ft ²	ft	ft ³	ft ³	acre-ft	acre-ft

7. **WQ_v Orifice Computations**
 Average ED release rate (if applicable)
 Average head, $h = (ED \text{ elev.} - \text{Permanent pool elev.}) / 2$
 Area of orifice from orifice equation
 $Q = CA(2gh)^{0.5}$

 Discharge equation $Q = (h)^{0.5}$

 Compute release rate for SP_v-ED control and establish SP_v elevation
 Release rate =
 Average head, $h = SP_v \text{ elev.} - \text{Permanent pool elev.} / 2$
 Area of orifice from orifice equation
 $Q = CA(2gh)^{0.5}$
 Discharge equation $Q = (h)^{0.5}$

release rate = _____ cfs
 $h =$ _____ ft

 $A =$ _____ ft²
 diameter = _____ in
 factor = _____ (h)^{0.5}

 WSEL = _____ ft-NGVD
 release rate = _____ cfs
 $h =$ _____ ft-NGVD
 $A =$ _____ ft²
 diameter = _____ in
 factor = _____ (h)^{0.5}

8. Calculate Q_p release rate and WSEL

Set up a stage-storage-discharge relationship

Elevation	Storage	Low Flow		Riser		Barrel		Emergency	Total
		WQ _v -ED	SP _v -ED	High Storage		Inlet	Pipe	Spillway	Storage
MSL	ac-ft	H(ft) Q(cfs)	H(ft) Q(cfs)	Orif. HQ	Weir HQ	H(ft) Q(cfs)	H(ft) Q(cfs)	H(ft) Q(cfs)	Q(cfs)

Q_p = pre-dev. Peak discharge - (WQ_v-ED release + SP_v-ED release)

Maximum head =
 Use weir equation for slot length ($Q = CLH^{3/2}$)

Check inlet condition
 Check outlet condition

9. Size emergency spillway, calculate 100-year WSEL and set top of embankment elevation
10. Investigate potential pond hazard classification
11. Design inlets, sediment forebays, outlet structures, maintenance access, and safety features.
12. Attach landscaping plan

Q_p = _____ cfs
 $H =$ _____ ft
 $L =$ _____ ft

Use culvert charts (section 4.3)

WSEL₂₅ = _____ ft
 WSEL₁₀₀ = _____ ft
 Q_{ES} = _____ cfs
 Q_{PS} = _____ cfs

See Appendix H

See subsection 3.2.15 - D through H

See Appendix F

23.0 Green Roof

Structural Stormwater Control



Description: A green roof uses a small amount of substrate over an impermeable membrane to support a covering of plants. The green roof slows down runoff from the otherwise impervious roof surface as well as moderating rooftop temperatures. With the right plants, a green roof will also provide aesthetic or habitat benefits. Green roofs have been used in Europe for decades.

KEY CONSIDERATIONS

DESIGN CRITERIA:

- Relatively new in North America
- Potential for high failure rate if poorly designed, poorly constructed, not adequately maintained Minimum length to width ratio for the pond is 1.5:1

ADVANTAGES / BENEFITS:

- Provides reduction in runoff volume
- Higher initial cost when compared to conventional roofs, but potential for lower life cycle costs through longevity

DISADVANTAGES / LIMITATIONS:

- Requires additional roof support
- Requires more maintenance than regular roofs
- Special attention to design and construction needed
- Requires close coordination with plant specialists
- Potential for leakage due to plant roots penetrating membrane.

STORMWATER MANAGEMENT SUITABILITY

- P** Water Quality Protection
- S** Streambank Protection
- On-Site Flood Control
- Downstream Flood Control

IMPLEMENTATION CONSIDERATIONS

- L** Land Requirement
- L** Capital Cost
- H** Maintenance Burden

Residential Subdivision Use: No

High Density/Ultra-Urban: Yes

Drainage Area: No restrictions.

Soils: No restrictions.

Other Considerations:

- Hotspot Areas

POLLUTANT REMOVAL

85%	Total Suspended Solids
95/16%	Nutrients - Total Phosphorus / Total Nitrogen removal
25%	Metals - Cadmium, Copper, Lead, and Zinc removal
No Data	Pathogens - Coliform, Streptococci, E. Coli removal

L=Low M=Moderate H=High

23.1 General Description

Green roofs (also referred to as *ecoroofs*, *roof gardens*, or *roof meadows*) are vegetated roofs used in place of conventional roofing, such as gravel-ballasted roofs. They are used as part of sustainable development initiatives, along with narrow streets, permeable pavement, and various infiltration devices. There are two main types of green roofs. The first is what is called roof gardens or intensive green roofs. They may be thought of as a garden on the roof. They have a greater diversity of plants, including trees and shrubs, but require deeper soil, increased load bearing capacity, and require more maintenance. The second has been referred to as roof meadows or extensive green roofs. The vegetation is limited and similar to an alpine meadow, requiring less soil depth and minimal maintenance. Due to the considerably greater costs and structural design requirements, only the second type of green roof, the roof meadow or extensive type is discussed in this manual.

The extensive green roof is designed to control low-intensity storms by intercepting and retaining or storing water until the peak storm event has passed. The plants intercept and delay runoff by capturing and holding precipitation in the foliage, absorbing water in the root zone, and slowing the velocity of direct runoff by increasing retardance to flow and extending the flowpath through the vegetation. Water is also stored and evaporated from the growing media. Green roofs can capture and evaporate up to 100 percent of the incident precipitation, depending on the roof design and the storm characteristics.

Monitoring in Pennsylvania, for instance, showed reductions of approximately 2/3 in runoff from a green roof (15.5 inches runoff from 44 inches of rainfall). Furthermore, runoff was negligible for storm events of less than 0.6 inches. A study done for Portland, Oregon, indicated a reduction in stormwater discharges from the downtown area of between 11 and 15% annually if half of the roofs in the downtown area were retrofitted as green roofs.

Green roofs also:

- reduce the temperature of runoff,
- reduce the “heat island” effect of urban buildings,
- help insulate the building,
- improve visual aesthetics,
- protect roofs from weather,
- improve building insulation,
- reduce noise,
- and provide habitat for wildlife.

As with a conventional roof, a green roof must safely drain runoff from the roof. It may be desirable to drain the runoff to a rainwater harvesting system such as (rainbarrels or cisterns), or other stormwater facilities such as planters and swales.

Significant removals of heavy metals by green roofs have been reported, but there is not enough evidence to include removal rates at this time.

23.2 Design Criteria and Specifications

For either new installations or retrofits, an architect or structural engineer must be consulted to determine whether the building can provide the structural support needed for a green roof.

Generally, the building structure must be adequate to hold an additional 10 to 25 pounds per square foot (psf) saturated weight, depending on the vegetation and growth medium that will be used. (This is in addition to snow load requirements.) An existing rock ballast roof may be structurally sufficient to hold a 10-12 psf green roof, since ballast typically weighs 10-12 psf.

Green roofs can be used on flat or pitched roofs up to 40 percent. Although, on a roof slope greater than 20 degrees, the green roof installer needs to ensure that the plant layer does not slip or slump through its

own weight, especially when it becomes wet. Horizontal strapping, wood, plastic, or metal, may be necessary. Some commercial support grid systems are also available for this purpose.

A green roof typically consists of several layers, as shown in Figure 23.1. A waterproof membrane is placed over the roof's structure. A root barrier is placed on top of the membrane to prevent roots from penetrating the membrane and causing leaks. A layer for drainage is installed above this, followed by the growth media. The vegetation is then planted to form the top layer. Details of the various layers are given below.

Waterproof membranes are made of various materials, such as synthetic rubber (EPDM), hypolan (CPSE), reinforced PVC, or modified asphalts (bitumens). The membranes are available in various forms, liquid, sheets, or rolls. Check with the manufacturer to determine their strength and functional characteristics of the membrane under consideration.

Root barriers are made of dense materials or are treated with copper or other materials that inhibit root penetration, protecting the waterproof membrane from being breached. A root barrier may not be necessary for synthetic rubber or reinforced PVC membranes, but will likely be needed for asphalt mixtures. Check with the manufacturer to determine if a root barrier is required for a particular product.

The drainage layer of a green roof is usually constructed of various forms of plastic sheeting, a layer of gravel, or in some cases, the growth medium.

The growth medium is generally 2 to 6 inches thick and made of a material that drains relatively quickly. Commercial mixtures containing coir (coconut fiber), pumice, or expanded clay are available. Sand, gravel, crushed brick, and peat are also commonly used. Suppliers recommend limiting organic material to less than 33% to reduce fire hazards. The City of Portland, Oregon has found a mix of 1/3 topsoil, 1/3 compost, and 1/3 perlite may be sufficient for many applications. Growth media can weigh from 16 to 35 psf when saturated depending on the type (intensive/extensive), with the most typical range being from 10-25 psf.

When dry, all of the growth media are light-weight and prone to wind erosion. It is important to keep media covered before planting and ensure good coverage after vegetation is established.

Selecting the right vegetation is critical to minimize maintenance requirements. Due to the shallowness of the growing medium and the extreme desert-like microclimate on many roofs, plants are typically alpine, dryland, or indigenous. Ideally, the vegetation should be:

- Drought-tolerant, requiring little or no irrigation after establishment
- Self-sustaining, without fertilizers, pesticides, or herbicides
- Able to withstand heat, cold, and high winds
- Shallow root structure
- Low growing, needing little or no mowing or trimming
- Fire resistant
- Perennial or self propagating, able to spread and cover blank spots by itself

Visit www.txsmartscape.com to look up plants meeting the above criteria.

A mix of sedum/succulent plant communities is recommended because they possess many of these attributes. Certain wildflowers, herbs, forbs, grasses, mosses, and other low groundcovers can also be used to provide additional habitat benefits or aesthetics; however, these plants need more watering and maintenance to survive and keep their appearance.

Green roof vegetation is usually established by one or more of the following methods: seeding, cuttings, vegetation mats, and plugs/potted plants.

- Seeds can be either hand sown or broadcast in a slurry (hydraseeded). Seeding takes longer to establish and requires more weeding, erosion control, and watering than the other methods.

- Cuttings or sprigs are small plant sections. They are hand sown and require more weeding, erosion control, and watering than mats.
- Vegetation mats are sod-like mats that achieve full plant coverage very quickly. They provide immediate erosion control, do not need mulch, and minimize weed intrusion. They generally require less ongoing maintenance than the other methods.
- Plugs or potted plants may provide more design flexibility than mats. However, they take longer to achieve full coverage, are more prone to erosion, need more watering during establishment, require mulching, and more weeding.

Green roof vegetation is most easily established during the spring or fall.

Irrigation is necessary during the establishment period and possibly during drought conditions, regardless of the planting method used. The goal is to minimize the need for irrigation by paying close attention to plant selection, soil, and various roof characteristics.

Installation costs for green roofs generally run from \$10 to \$25 per square foot, as compared to \$3 to \$20 per square foot for a conventional roof. However, the longer lifespan of a green roof (reportedly 40 years or up to twice as long as a conventional roof) and lower maintenance costs offset this.

Provide controlled overflow point(s) to prevent overloading of roof.

23.3 Inspection and Maintenance Requirements

Activity	Schedule
Watering to help establish vegetation	As needed
Replant to cover bare spots or dead plants	Monthly
Weeding (as needed, based on inspection)	Two or three times yearly
Water and mowing to prevent fire hazards (if grasses or similar plants are used)	As needed
Inspect drains for clogging	Twice per year
Inspect the roof for leakage	Annually, or as needed
If leaks occur, remove and stockpile vegetation, growth media, and drainage layer. Replace membrane and root barrier, followed by stockpiled material.	Upon failure

23.4 Example Schematic

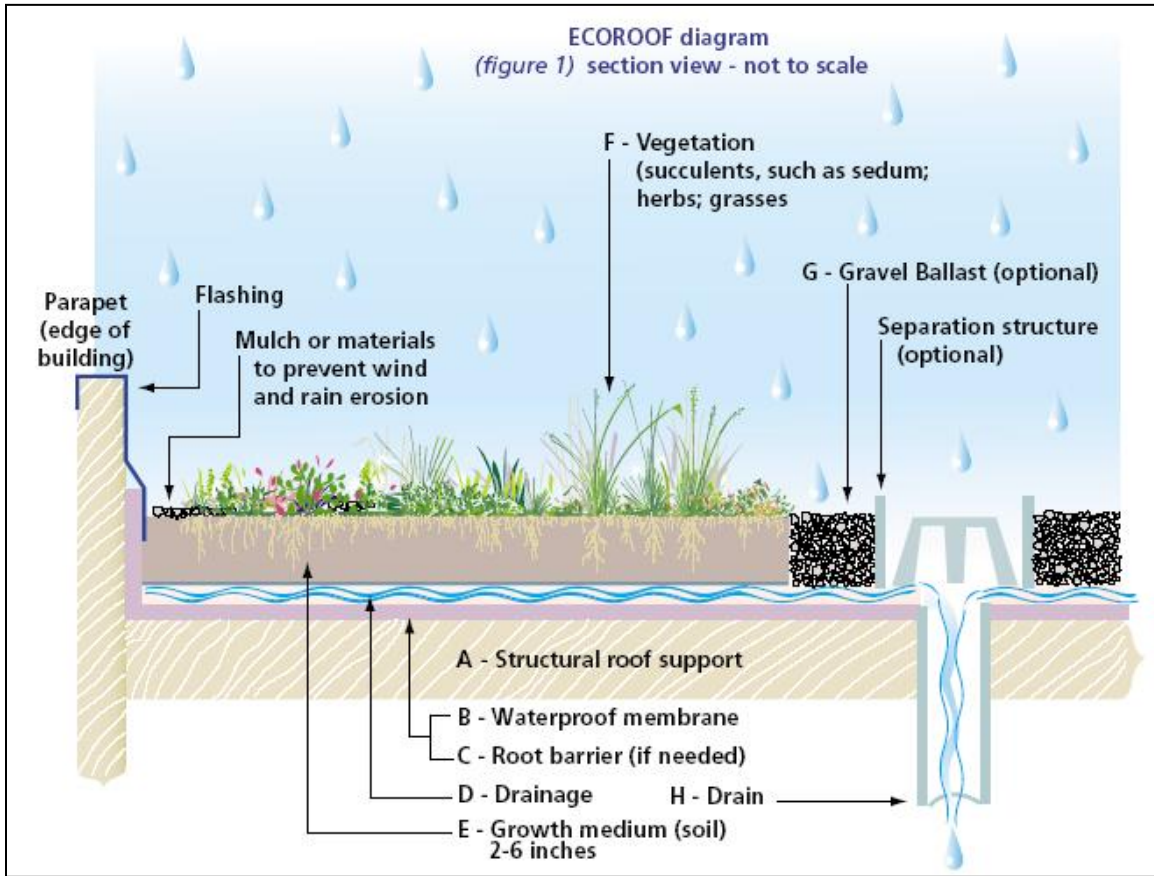

Figure 23.1 Green Roof Cross Section (from City of Portland, Oregon)

24.0 Modular Porous Paver Systems

Structural Stormwater Control



Description: A pavement surface composed of structural units with void areas that are filled with pervious materials such as sand or grass turf. Porous pavers are installed over a gravel base course that provides storage as runoff infiltrates through the porous paver system into underlying permeable soils.

KEY CONSIDERATIONS

DESIGN CRITERIA:

- Intended for low traffic areas, or for residential or overflow parking applications
- Soil infiltration rate of 0.5 in/hr or greater required

ADVANTAGES / BENEFITS:

- Provides reduction in runoff volume
- High level of pollutant removal
- Available from commercial vendors

DISADVANTAGES / LIMITATIONS:

- High maintenance requirements
- High cost compared to conventional pavements
- Potential for high failure rate if not adequately maintained or used in unstabilized areas
- Potential for groundwater contamination

STORMWATER MANAGEMENT SUITABILITY

- S** Water Quality Protection
- S** Streambank Protection
- On-Site Flood Control**
- Downstream Flood Control**

IMPLEMENTATION CONSIDERATIONS

- L** Land Requirement
- M** Capital Cost
- H** Maintenance Burden

Residential Subdivision Use: No
High Density/Ultra-Urban: Yes
Drainage Area: No restrictions.
Soils: Soil infiltration rate of 0.5 in/hr or greater required.

POLLUTANT REMOVAL

NA	Total Suspended Solids
80/80%	Nutrients - Total Phosphorus / Total Nitrogen removal
90%	Metals - Cadmium, Copper, Lead, and Zinc removal
No Data	Pathogens - Coliform, Streptococci, E. Coli removal

L=Low M=Moderate H=High

24.1 General Description

Modular porous pavers are structural units, such as concrete blocks, bricks, or reinforced plastic mats, with regularly interspersed void areas used to create a load-bearing pavement surface. The void areas are filled with pervious materials (gravel, sand, or grass turf) to create a system that allows for the infiltration of stormwater runoff. Porous paver systems provide water quality benefits in addition to groundwater recharge and a reduction in stormwater volume. The use of porous paver systems results in a reduction of the effective impervious area on a site.

There are many different types of modular porous pavers available from different manufacturers, including both pre-cast and mold in-place concrete blocks, concrete grids, interlocking bricks, and plastic mats with hollow rings or hexagonal cells (see Figure 24.1).

Modular porous pavers are typically placed on a gravel (stone aggregate) base course. Runoff infiltrates through the porous paver surface into the gravel base course, which acts as a storage reservoir as it infiltrates to the underlying soil. The infiltration rate of the soils in the subgrade must be adequate to support drawdown of the entire runoff capture volume within 24 to 48 hours. Special care must be taken during construction to avoid undue compaction of the underlying soils, which could affect the soils' infiltration capability.

Modular porous paver systems are typically used in low-traffic areas such as the following types of applications:

- Parking pads in parking lots
- Overflow parking areas
- Residential driveways
- Residential street parking lanes
- Recreational trails
- Golf cart and pedestrian paths
- Emergency vehicle and fire access lanes

A major drawback is the cost and complexity of modular porous paver systems compared to conventional pavements. Porous paver systems require a very high level of construction workmanship to ensure that they function as designed and do not settle unevenly. In addition, there is the difficulty and cost of rehabilitating the surfaces should they become clogged. Therefore, consideration of porous paver systems should include the construction and maintenance requirements and costs.

24.2 Pollutant Removal Capabilities

As they provide for the infiltration of stormwater runoff, porous paver systems have a high removal of both soluble and particulate pollutants, where they become trapped, absorbed, or broken down in the underlying soil layers. Due to the potential for clogging, porous paver surfaces should not be used for the removal of sediment or other coarse particulate pollutants.

The following design pollutant removal rates are conservative average pollutant reduction percentages for design purposes derived from sampling data, modeling, and professional judgment.

- Total Suspended Solids – not applicable
- Total Phosphorus – 80%
- Total Nitrogen – 80%
- Fecal Coliform – insufficient data
- Heavy Metals – 90%

24.3 Design Criteria and Specifications

Porous paver systems can be used where the underlying in-situ subsoils have an infiltration rate of between 0.5 and 3.0 inches per hour. Therefore, porous paver systems are not suitable on sites with hydrologic group D or most group C soils, or soils with a high (>30%) clay content. During construction and preparation of the subgrade, special care must be taken to avoid compaction of the soils.

Porous paver systems should ideally be used in applications where the pavement receives tributary runoff only from impervious areas. The ratio of the contributing impervious area to the porous paver surface area should be no greater than 3:1.

If runoff is coming from adjacent pervious areas, it is important that those areas be fully stabilized to reduce sediment loads and prevent clogging of the porous paver surface.

Porous paver systems are not recommended on sites with a slope greater than 2%.

A minimum of 2 feet of clearance is required between the bottom of the gravel base course and underlying bedrock or the seasonally high groundwater table.

Porous paver systems should be sited at least 10 feet downgradient from buildings and 100 feet away from drinking water wells.

An appropriate modular porous paver should be selected for the intended application. A minimum of 40% of the surface area should consist of open void space. If it is a load bearing surface, then the pavers should be able to support the maximum load.

The porous paver infill is selected based upon the intended application and required infiltration rate. Masonry sand (such as ASTM C-33 concrete sand or TxDOT item 421 Fine Aggregate) has a high infiltration rate (8 in/hr) and should be used in applications where no vegetation is desired. A sandy loam soil has a substantially lower infiltration rate (1 in/hr), but will provide for growth of a grass ground cover.

A 1-inch top course (filter layer) of sand (ASTM C-33 concrete sand or TxDOT item 421 Fine Aggregate) underlain by filter fabric is placed under the porous pavers and above the gravel base course.

The gravel base course should be designed to store at a minimum the water quality protection volume (WQ_v). The stone aggregate used should be washed, bank-run gravel, 1.5 to 2.5 inches in diameter with a void space of about 40% (ASTM C-33 Size No. 3 Coarse Aggregate). Aggregate contaminated with soil shall not be used. A porosity value (void space/total volume) of 0.32 should be used in calculations.

The gravel base course must have a minimum depth of 9 inches. The following equation can be used to determine if the depth of the storage layer (gravel base course) needs to be greater than the minimum depth:

$$d = V / A * n \quad (24.1)$$

where:

- d = Gravel Layer Depth (feet)
- V = Water Quality Protection Volume –or– Total Volume to be Infiltrated (cubic feet)
- A = Surface Area (square feet)
- n = Porosity (use n=0.32)

The surface of the subgrade should be lined with filter fabric or an 8-inch layer of sand (ASTM C-33 concrete sand or TxDOT item 421 Fine Aggregate) and be completely flat to promote infiltration across the entire surface.

Porous paver system designs must use some method to convey larger storm event flows to the conveyance system. One option is to use storm drain inlets set slightly above the elevation of the pavement. This would allow for some ponding above the surface, but would accept bypass flows that are too large to be infiltrated by the porous paver system, or if the surface clogs.

For the purpose of sizing downstream conveyance and structural control system, porous paver surface areas can be assumed to be 35% impervious. In addition, a reduction in water quality volume requirements can be obtained for the runoff volume infiltrated from other impervious areas using the methodology in [Section 1.0 of the Planning Technical Manual](#).

24.4 Inspection and Maintenance Requirements

Activity	Schedule
<ul style="list-style-type: none"> • Ensure that the porous paver surface is free of extraneous sediment. • Check to make sure that the system dewateres between storms. 	Monthly
<ul style="list-style-type: none"> • Clear debris from contributing area and porous paver surface. • Stabilize and mow contributing adjacent areas and remove clippings. 	As needed, based on inspection
<ul style="list-style-type: none"> • Vacuum sweep porous paver surface to keep free of sediment. 	Typically three to four times a year
<ul style="list-style-type: none"> • Inspect the surface for deterioration or spalling. 	Annually
<ul style="list-style-type: none"> • Totally rehabilitate the porous paver system, including the top and base course. 	Upon failure

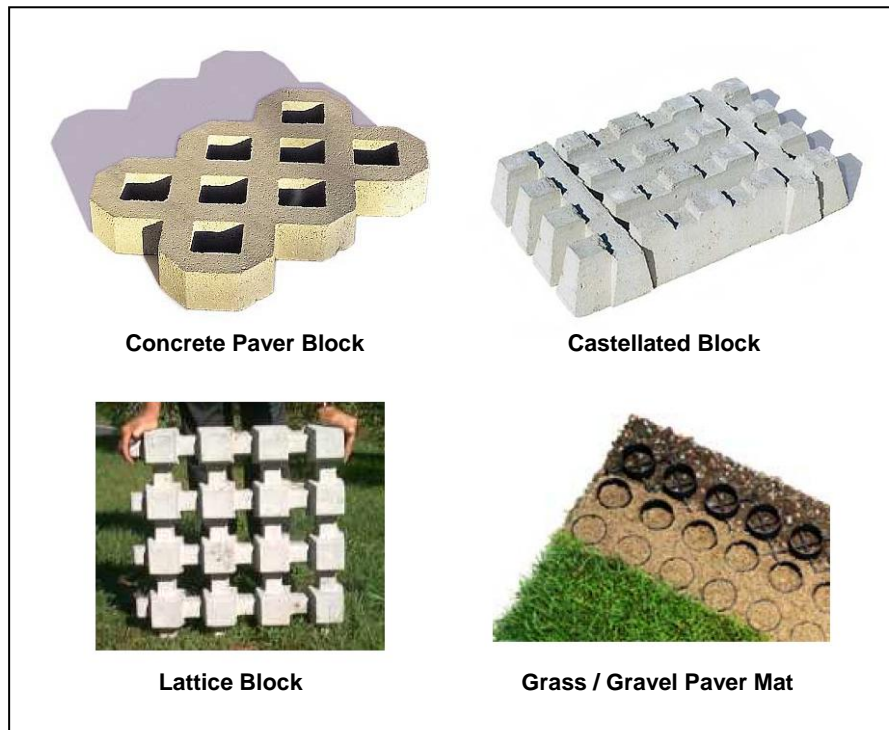

Figure 24.1 Examples of Modular Porous Pavers

24.5 Example Schematics

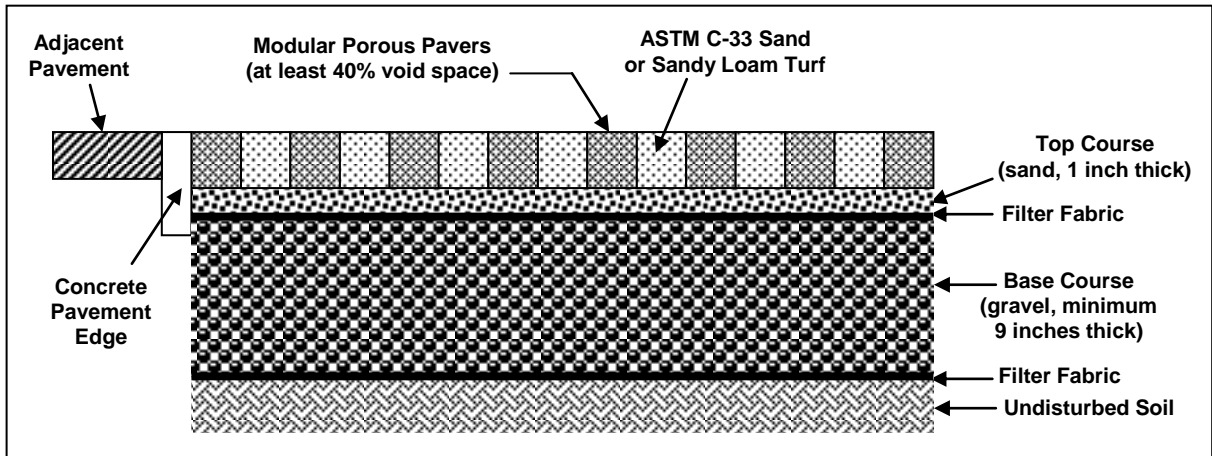

Figure 24.2 Modular Porous Paver System Section

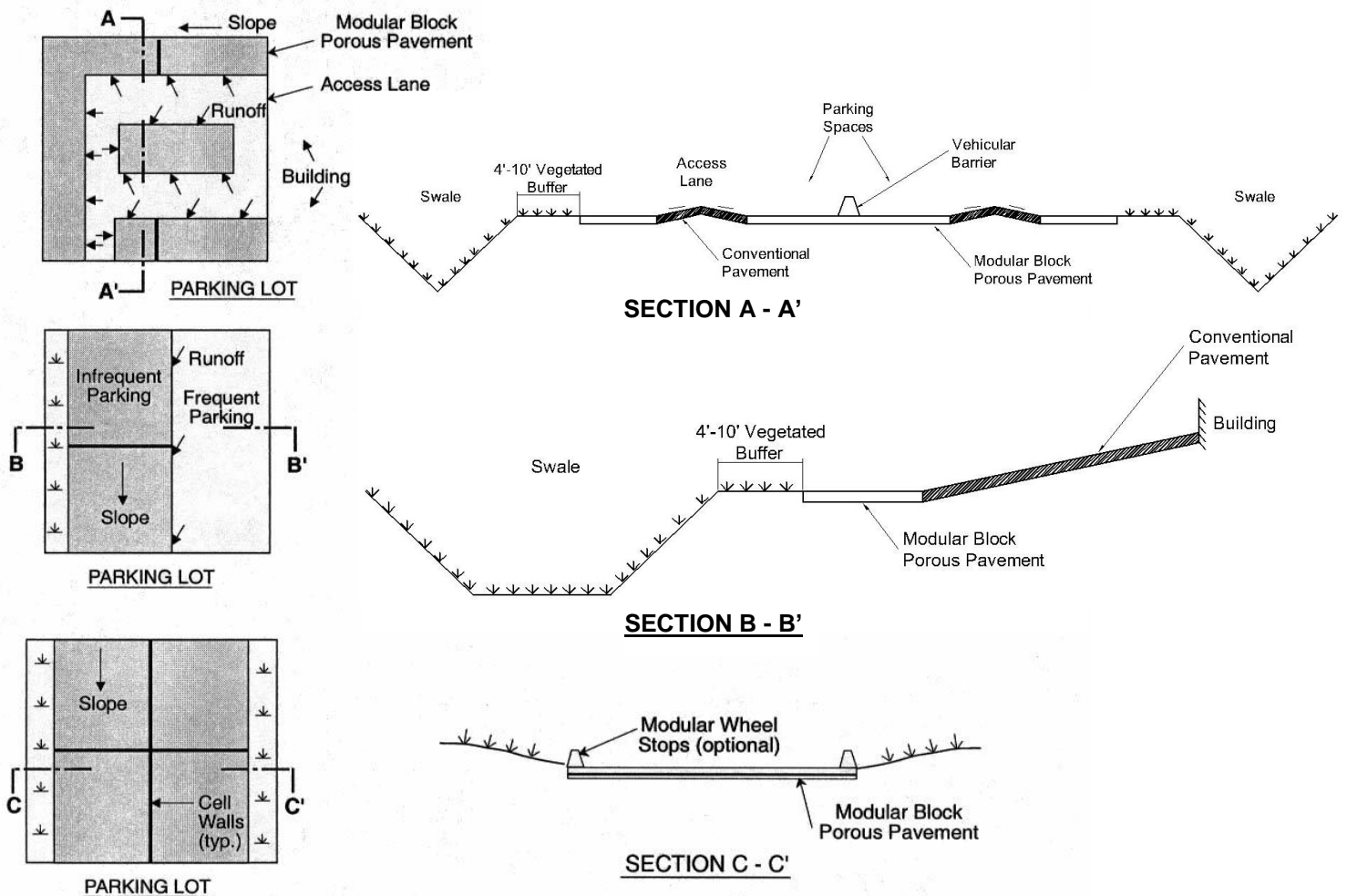

Figure 24.3 Typical Modular Porous Paver System Applications
(Source: UDFCD, 1999)

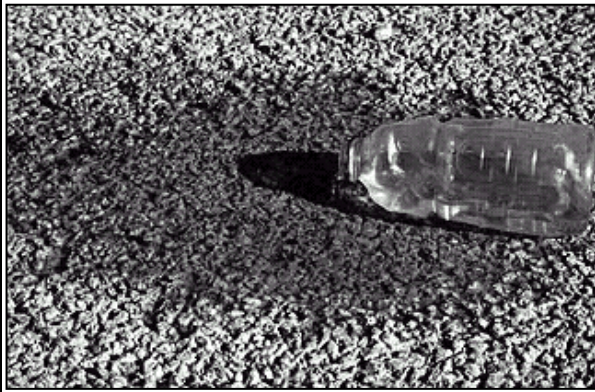

Figure 24.4 Examples of Porous Paver Surfaces

(Sources: Invisible Structures, Inc.; EP Henry Corp.)

25.0 Porous Concrete

**Limited Application
Structural Stormwater Control**



Description: Porous concrete is the term for a mixture of coarse aggregate, portland cement and water that allows for rapid infiltration of water and overlays a stone aggregate reservoir. This reservoir provides temporary storage as runoff infiltrates into underlying permeable soils and/or out through an underdrain system.

KEY CONSIDERATIONS

DESIGN CRITERIA:

- Intended for low volume auto traffic areas, or for overflow parking applications
- Should not be used in areas of soils with low permeability, wellhead protection zones, or recharge areas of water supply aquifer recharge areas.
- Soil infiltration rate of 0.5 in/hr or greater required
- Excavated area filled with stone media; gravel and sand filter layers with observation well

ADVANTAGES / BENEFITS:

- Pre-treat runoff if sediment present
- Provides reduction in runoff volume

DISADVANTAGES / LIMITATIONS:

- Restrictions on use by heavy vehicles
- High maintenance requirements
- Special attention to design and construction needed
- Somewhat higher cost when compared to conventional pavements
- Potential for high failure rate if poorly designed, poorly constructed, not adequately maintained, or used in unstabilized areas
- Potential for groundwater contamination

**STORMWATER
MANAGEMENT SUITABILITY**

- Water Quality Protection**
- Streambank Protection**
- On-Site Flood Control**
- Downstream Flood Control**

**IMPLEMENTATION
CONSIDERATIONS**

- Land Requirement**
- Capital Cost**
- Maintenance Burden**

Residential Subdivision Use: No

High Density/Ultra-Urban: Yes

Drainage Area: 5 acres max.

Soils: No restrictions

Other Considerations:

- Overflow Parking, driveway

POLLUTANT REMOVAL

NA	Total Suspended Solids
50/65%	Nutrients - Total Phosphorus / Total Nitrogen removal
60%	Metals - Cadmium, Copper, Lead, and Zinc removal
No	Pathogens - Coliform, Streptococci, E.Coli removal

L=Low M=Moderate H=High

25.1 General Description

Porous concrete (also referred to as *enhanced porosity concrete*, *porous concrete*, *portland cement pervious pavement*, and *pervious pavement*) is a subset of a broader family of pervious pavements including porous asphalt, and various kinds of grids and paver systems. Porous concrete is thought to have a greater ability than porous asphalt to maintain its porosity in hot weather and thus is provided as a limited application control in this manual. Although, porous concrete has seen growing use, there is still very limited practical experience with this measure. According to the U.S. EPA, porous pavement sites have had a high failure rate – approximately 75 percent. Failure has been attributed to poor design, inadequate construction techniques, soils with low permeability, heavy vehicular traffic, and poor maintenance. This measure, if used, should be carefully monitored over the life of the development.

Porous concrete consists of a specially formulated mixture of portland cement; uniform, open graded course aggregate; and water. The concrete layer has a high permeability often many times that of the underlying permeable soil layer which allows rapid percolation of rainwater through the surface and into the layers beneath. The void space in porous concrete is in the 15% to 22% range compared to three to five percent for conventional pavements. The permeable surface is placed over a layer of open-graded gravel and crushed stone. The void spaces in the stone act as a storage reservoir for runoff.

Porous concrete is designed primarily for stormwater quality, i.e. the removal of stormwater pollutants. However, it can provide limited runoff quantity control, particularly for smaller storm events. For some smaller sites, trenches can be designed to capture and infiltrate the streambank protection volume (SP_v) in addition to WQ_v. Porous concrete will need to be used in conjunction with another structural control to provide downstream flood control, if required.

Modifications or additions to the standard design have been used to pass flows and volumes in excess of the water quality volume, or to increase storage capacity or treatment. These include:

- Placing a perforated pipe near the top of the crushed stone reservoir to pass excess flows after the reservoir is filled
- Providing surface detention storage in a parking lot, adjacent swale, or detention pond with suitable overflow conveyance
- Connecting the stone reservoir layer to a stone filled trench
- Adding a sand layer and perforated pipe beneath the stone layer for filtration of the water quality volume
- Placing an underground detention tank or vault system beneath the layers

The infiltration rate of the soils in the subgrade should be adequate to support drawdown of the entire runoff capture volume within 24 to 48 hours. Special care must be taken during construction to avoid undue compaction of the underlying soils which could affect the soils' infiltration capability.

Porous concrete systems are typically used in low-traffic areas such as the following types of applications:

- Parking pads in parking lots
- Overflow parking areas
- Residential street parking lanes
- Recreational trails
- Golf cart and pedestrian paths
- Emergency vehicle and fire access lanes

Slopes should be flat or gentle to facilitate infiltration versus runoff and the seasonally high water table or bedrock should be a minimum of two feet below the bottom of the gravel layer if infiltration is to be relied on to remove the stored volume.

Porous concrete has the positive characteristics of volume reduction due to infiltration, groundwater recharge, and an ability to blend into the normal urban landscape relatively unnoticed. It also allows a reduction in the cost of other stormwater infrastructure, a fact that may offset the greater placement cost somewhat.

A drawback is the cost and complexity of porous concrete systems compared to conventional pavements. Porous concrete systems require a very high level of construction workmanship to ensure that they function as designed. They experience a high failure rate if they are not designed, constructed, and maintained properly.

Like other infiltration controls, porous concrete should not be used in areas that experience high rates of wind erosion, where highly erosive soils are present, or in drinking water aquifer recharge areas. Also it cannot be used in traffic areas where sanding is used during winter weather.

25.2 Pollutant Removal Capabilities

As they provide for the infiltration of stormwater runoff, porous concrete systems have a high removal of both soluble and particulate pollutants. These pollutants become trapped, absorbed, or broken down in the underlying soil layers. Due to the potential for clogging, porous concrete surfaces should not be used for the removal of sediment or other coarse particulate pollutants.

The following design pollutant removal rates are conservative average pollutant reduction percentages for design purposes derived from sampling data, modeling and professional judgment.

- Total Suspended Solids – not applicable
- Total Phosphorus – 50%
- Total Nitrogen – 65%
- Fecal Coliform – insufficient data
- Heavy Metals – 60%

Pollutant removal can be improved through routine vacuum sweeping and high pressure washing, insuring a drainage time of at least 24 hours, pretreating the runoff, having organic material in the subsoil, and using clean washed aggregate (EPA, 1999).

25.3 Design Criteria and Specifications

Porous concrete systems can be used where the underlying in-situ subsoils have an infiltration rate greater than 0.5 inches per hour. Therefore, porous concrete systems are not suitable on sites with hydrologic group D or most group C soils, or soils with a high (>30%) clay content. During construction and preparation of the subgrade, special care must be taken to avoid compaction of the underlying soils.

Porous concrete systems should typically be used in applications where the pavement receives tributary runoff only from impervious areas. Actual pervious surface area sizing will depend on achieving a 24 hour minimum and 48 hour maximum draw down time for the design storm volume.

If runoff is coming from adjacent pervious areas, it is important that those areas be fully stabilized to reduce sediment loads and prevent clogging of the porous paver surface. Pretreatment using filter strips or vegetated swales for removal of coarse sediments is recommended. (see [Sections 4.0 and 13.0](#))

Porous concrete systems should not be used on slopes greater than 5% with slopes of no greater than 2% recommended. For slopes greater than 1% barriers perpendicular to the direction of drainage should be installed in sub-grade material to keep it from washing away, or filter fabric should be placed at the bottom and sides of the aggregate to keep soil from migrating into the aggregate and reducing porosity.

A minimum of four feet of clearance is recommended between the bottom of the gravel base course and underlying bedrock or the seasonally high groundwater table.

Porous concrete systems should be sited at least 10 feet down-gradient from buildings and 100 feet away from drinking water wells.

To protect groundwater from potential contamination, runoff from designated hotspot land uses or activities must not be infiltrated. Porous concrete should not be used for manufacturing and industrial sites, where there is a potential for high concentrations of soluble pollutants and heavy metals. In addition, porous concrete should not be considered for areas with a high pesticide concentration. Porous concrete is also not suitable in areas with karst geology without adequate geotechnical testing by qualified individuals and in accordance with local requirements.

Porous concrete system designs must use some method to convey larger storm event flows to the conveyance system. One option is to use storm drain inlets set slightly above the elevation of the pavement. This would allow for some ponding above the surface, but would accept bypass flows that are too large to be infiltrated by the porous concrete system, or if the surface clogs.

For the purpose of sizing downstream conveyance and structural control system, porous concrete surface areas can be assumed to 35% impervious. In addition, reduction in water quality volume requirements can be obtained for the runoff volume infiltrated from other impervious areas using the methodology in [Section 1.0 of the Planning Technical Manual](#).

For treatment control, the design volume should be, at a minimum, equal to the water quality volume. The water quality storage volume is contained in the surface layer, the aggregate reservoir, and the sub-grade above the seasonal high water table – if the sub-grade is sandy. The storm duration (fill time) is normally short compared to the infiltration rate of the sub-grade, a duration of two hours can be used for design purposes. The total storage volume in a layer is equal to the percent of voids times the volume of the layer. Alternately storage may be created on the surface through temporary ponding, though this would tend to accelerate clogging if coarse sediment or mud settles out on the surface.

The cross-section typically consists of four layers, as shown in Figure 25.1. The aggregate reservoir can sometimes be avoided or minimized if the sub-grade is sandy and there is adequate time to infiltrate the necessary runoff volume into the sandy soil without by-passing the water quality volume. Descriptions of each of the layers is presented below:

- **Porous Concrete Layer** – The porous concrete layer consists of an open-graded concrete mixture usually ranging from depths of 2 to 4 inches depending on required bearing strength and pavement design requirements. Porous concrete can be assumed to contain 18 percent voids (porosity = 0.18) for design purposes. Thus, for example, a 4 inch thick porous concrete layer would hold 0.72 inches of rainfall. The omission of the fine aggregate provides the porosity of the porous pavement. To provide a smooth riding surface and to enhance handling and placement a coarse aggregate of 3/8 inch maximum size is normally used. Use coarse aggregate (3/8 to No. 16) per ASTM C 33 or No. 89 coarse aggregate (3/8 to No. 50) per ASTM D 448.
- **Top Filter Layer** – Consists of a 0.5 inch diameter crushed stone to a depth of 1 to 2 inches. This layer serves to stabilize the porous concrete layer. It can be combined with reservoir layer using suitable stone.
- **Reservoir Layer** – The reservoir gravel base course consists of washed, bank-run gravel, 1.5 to 2.5 inches in diameter with a void space of about 40% meeting the gradation listed below. The depth of this layer depends on the desired storage volume, which is a function of the soil infiltration rate and void spaces, but typically ranges from two to four feet. The layer must have a minimum depth of nine inches. The layer should be designed to drain completely in 48 hours. and stored at a minimum the water quality volume (WQ_v). Aggregate contaminated with soil shall not be used. A porosity value (void space/total volume) of 0.32 should be used in calculations unless aggregate specific data exist.

Gradation	
Sieve Size	% Passing
2 ½"	100
2"	90 – 100
1 ½"	35 – 70
1"	0 – 15
½"	0 - 5

- **Bottom Filter Layer** – The surface of the subgrade should be an 6 inch layer of sand (ASTM C-33 concrete sand or TxDOT Fine Aggregate Grade No. 1) or a 2 inch thick layer of 0.5 inch crushed stone, and be completely flat to promote infiltration across the entire surface. This layer serves to stabilize the reservoir layer, to protect the underlying soil from compaction, and act as the interface between the reservoir layer and the filter fabric covering the underlying soil.
- **Filter Fabric** – It is very important to line the entire trench area, including the sides, with filter fabric prior to placement of the aggregate. The filter fabric serves a very important function by inhibiting soil from migrating into the reservoir layer and reducing storage capacity. Fabric should be MIRIFI # 14 N or equivalent.
- **Underlying Soil** – The underlying soil should have an infiltration capacity of at least 0.5 in/hr, but preferably greater than 0.50 in/hr. as initially determined from NRCS soil textural classification, and subsequently confirmed by field geotechnical tests. The minimum geotechnical testing is one test hole per 5000 square feet, with a minimum of two borings per facility (taken within the proposed limits of the facility). Infiltration trenches cannot be used in fill soils. Soils at the lower end of this range may not be suited for a full infiltration system. Test borings are recommended to determine the soil classification, seasonal high ground water table elevation, and impervious substrata, and an initial estimate of permeability. Often a double-ring infiltrometer test is done at subgrade elevation to determine the infiltration rate of the least permeable layer, and, for safety, one-half that measured value is taken for infiltration calculations.

The pit excavation should be limited to the width and depth specified in the design. Excavated material should be placed away from the open trench as not to jeopardize the stability of the trench sidewalls. The bottom of the excavated trench should not be loaded so as to cause compaction, and should be scarified prior to placement of sand. The sides of the trench shall be trimmed of all large roots. The sidewalls shall be uniform with no voids and scarified prior to backfilling. All infiltration trench facilities should be protected during site construction, and should be constructed after upstream areas have been stabilized.

An observation well consisting of perforated PVC pipe 4 to 6 inches in diameter should be placed at the downstream end of the facility and protected. The well should be used to determine actual infiltration rates.

A warning sign should be placed at the facility that states, "Porous Paving used on this site to reduce pollution. Do not resurface with non-porous material or sand during icy weather. Call the local jurisdiction for more information."

Details of construction of the concrete layer are beyond the scope of this manual. However, construction of porous concrete is exacting, and requires special handling, timing, and placement to perform adequately (LACDPW, 2000, Paine, 1992, Maryland, 1984).

25.4 Inspection and Maintenance Requirements

Activity	Schedule
• Initial inspection	Monthly for three months after installation
• Ensure that the porous paver surface is free of sediment	Monthly
• Ensure that the contributing and adjacent area is stabilized and mowed, with clippings removed	As needed, based on inspection
• Vacuum sweep porous concrete surface followed by high pressure hosing to keep pores free of sediment	Four times a year

Activity	Schedule
<ul style="list-style-type: none"> Inspect the surface for deterioration or spalling Check to make sure that the system dewateres between storms 	Annually
<ul style="list-style-type: none"> Spot clogging can be handled by drilling half-inch holes through the pavement every few feet Rehabilitation of the porous concrete system, including the top and base course as needed 	Upon failure

To ensure proper maintenance of porous pavement, a carefully worded maintenance agreement is essential. It should include specific the specific requirements and establish the responsibilities of the property owner and provide for enforcement.

25.5 Example Schematics

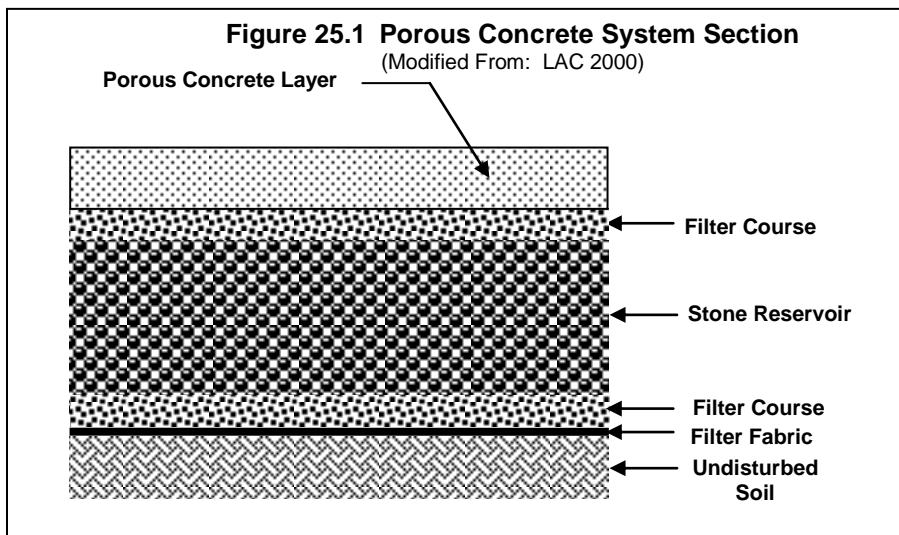



Figure 25.2 Porous Concrete System Installation



Figure 25.3 Typical Porous Concrete System Applications
(Photos by Bruce Ferguson, Don Wade)

25.6 Design Example

Data

A 1.5 acre overflow parking area is to be designed to provide water quality treatment using porous concrete to handle the runoff from the whole overflow parking area. Initial data shows:

- Rainfall depth for treatment is up to 1.5 inches
- Borings show depth to water table is 5.0 feet
- Boring and infiltrometer tests show sand-loam with percolation rate (k) of 1.02 inches/hr
- Structural design indicates the thickness of the porous concrete must be at least three inches

Water Quality Volume

$$R_v = 0.05 + 0.009 I \quad (\text{where } I = 100 \text{ percent})$$

$$= 0.95$$

$$WQ_v = 1.5 R_v A / 12 = 1.5 * 0.95 * 1.5/12 = 0.178 \text{ acre-feet}$$

$$= (0.178 \text{ ac-ft}) (43,560 \text{ cu-ft/ac-ft}) = 7,759 \text{ cubic feet}$$

Surface Area

A porosity value $n = 0.32$ should be used for the gravel and 0.18 for the concrete layer.

All infiltration systems should be designed to fully de-water the entire WQ_v within 24 to 48 hours after the rainfall event at the design percolation rate.

A fill time $T=2$ hours can be used for most designs.

Chose a depth of gravel pit of three feet (including layer under concrete) which fits the site with a two foot minimum to water table (other lesser depths could be chosen, making the surface area larger). The minimum surface area of the trench can be determined, in a manner similar to the infiltration trench, from the Equation 20.1:

$$A = WQ_v / (n_g d_g + kT/12 + n_p d_p)$$

$$= 7,759 / (0.32 * 3 + 1.02 * 2/12 + 0.18 * 3/12)$$

$$= 6,604 \text{ square feet}$$

Where:

- A = Surface Area
- WQ_v = Water Quality Volume (or total volume to be infiltrated)
- n = porosity (g of the gravel, p of the concrete layer)
- d = depth or gravel layer (feet) (g of the gravel, p of the concrete layer)
- k = percolation (inches/hour)
- T = Fill Time (time for the practice to fill with water), in hours

Check of drain time:

$$\text{depth} = 3 * 12 + 3 \text{ inches to sand layer} = 39 \text{ inches @ } 1.02 \text{ in/hr} = 38 \text{ hours (ok)}$$

Overflow will be carried across the porous concrete and tied into the drainage system for the rest of the site.

26.0 Proprietary Structural Controls

Limited Application Structural Stormwater Control

Description: Manufactured structural control systems available from commercial vendors designed to treat stormwater runoff and/or provide water quantity control

<p style="text-align: center;"><u>KEY CONSIDERATIONS</u></p> <p>DESIGN CRITERIA:</p> <ul style="list-style-type: none"> Independent performance data must be available to prove a demonstrated capability of meeting stormwater management goal(s) System or device must be appropriate for use in North Central Texas conditions, and specifically for the community in question Pre-treat runoff if sediment present <p>ADVANTAGES / BENEFITS:</p> <ul style="list-style-type: none"> Provides reduction in runoff volume <p>DISADVANTAGES / LIMITATIONS:</p> <ul style="list-style-type: none"> Depending on the proprietary system, there may be: <ul style="list-style-type: none"> Limited performance data Application constraints High maintenance requirements Higher costs than other structural control alternatives Installation and operations/maintenance requirements must be understood by all parties approving and using the system or device in question 	<p style="text-align: center;"><u>STORMWATER MANAGEMENT SUITABILITY</u></p> <ul style="list-style-type: none"> <input checked="" type="checkbox"/> Water Quality Protection <input checked="" type="checkbox"/> Streambank Protection <input checked="" type="checkbox"/> On-Site Flood Control <input checked="" type="checkbox"/> Downstream Flood Control <p style="text-align: center;"><u>IMPLEMENTATION CONSIDERATIONS</u></p> <ul style="list-style-type: none"> <input type="checkbox"/> Land Requirement <input type="checkbox"/> Capital Cost <input type="checkbox"/> Maintenance Burden <p>Residential Subdivision Use: Depends on the specific proprietary structural control</p> <p>High Density/Ultra-Urban: Yes</p> <p>Drainage Area: Depends on the specific proprietary structural control.</p> <p>Soils: No restrictions</p> <div style="border: 1px solid black; padding: 5px; text-align: center;"> <p>L=Low M=Moderate H=High</p> </div>
--	--

Note: It is the policy of this Manual not to recommend any specific commercial vendors for proprietary systems. However, this section is being included in order to provide communities with a rationale for approving the use of a proprietary system or practice in their jurisdictions.

26.1 General Description

There are many types of commercially-available proprietary stormwater structural controls available for both water quality treatment and quantity control. These systems include:

- Hydrodynamic systems such as gravity and vortex separators
- Filtration systems
- Catch basin media inserts
- Chemical treatment systems
- Package treatment plants
- Prefabricated detention structures

Many proprietary systems are useful on small sites and space-limited areas where there is not enough land or room for other structural control alternatives. Proprietary systems can often be used in pretreatment applications in a treatment train. However, proprietary systems are often more costly than other alternatives and may have high maintenance requirements. Perhaps the largest difficulty in using a proprietary system is the lack of adequate independent performance data, particularly for use in North Central Texas conditions. Below are general guidelines that should be followed before considering the use of a proprietary commercial system.

26.2 Guidelines for Using Proprietary Systems

In order for use as a limited application control, a proprietary system must have a demonstrated capability of meeting the stormwater management goals for which it is being intended. This means that the system must provide:

1. Independent third-party scientific verification of the ability of the proprietary system to meet water quality treatment objectives and/or to provide water quantity control (streambank or flood control)
2. Proven record of longevity in the field
3. Proven ability to function in North Central Texas conditions (e.g., climate, rainfall patterns, soil types, etc.)
4. Maintainability - Documented procedures for required maintenance including collection and removal of pollutants or debris.

For a proprietary system to meet (1) above for water quality goals, the following monitoring criteria should be met for supporting studies:

- At least 15 storm events must be sampled
- The study must be independent or independently verified (i.e., may not be conducted by the vendor or designer without third-party verification)
- The study must be conducted in the field, as opposed to laboratory testing
- Field monitoring must be conducted using standard protocols which require proportional sampling both upstream and downstream of the device
- Concentrations reported in the study must be flow-weighted
- The propriety system or device must have been in place for at least one year at the time of monitoring

Although local data is preferred, data from other regions can be accepted as long as the design accounts for the local conditions. Local governments may submit a proprietary system to further scrutiny based on the performance of similar practices. A poor performance record or high failure rate is valid justification for not allowing the use of a proprietary system or device. Consult your local review authority for more information in regards to the use of proprietary structural stormwater controls.

27.0 Rain Harvesting (Tanks/Barrels)

Stormwater Control



Description: Rain harvesting is a container or system designed to capture and store rainwater discharged from a roof. The rain harvesting system consists of a storage container, a downspout diversion, a sealed lid, and an overflow system. Typical rain harvesting systems hold between 50 and 500 gallons of water, and may work in series to provide larger volumes of storage.

KEY CONSIDERATIONS

ADVANTAGES / BENEFITS:

- Provides reduction in runoff volume
- Low-cost, effective, and easy to maintain
- Offers flexibility with volume of water to capture
- Potential water savings
- Healthier for plants and gardens due to non-chlorinated water

DISADVANTAGES / LIMITATIONS:

- Small storage capacity
- Requires some attention
- If not attended to after a rain, leaking can cause damage to adjacent building foundation
- High construction cost when compared to the low cost of municipal water supply
- Certain roofing materials can cause runoff contamination (re-use)

STORMWATER MANAGEMENT SUITABILITY

- Water Quality Protection**
- Streambank Protection**
- On-Site Flood Control**
- Downstream Flood Control**

IMPLEMENTATION CONSIDERATIONS

- Land Requirement**
- Capital Cost**
- Maintenance Burden**

Residential Subdivision Use: Yes

High Density/Ultra-Urban: Yes

Drainage Area: depends on manufacture's model

Soils: No restrictions

L=Low M=Moderate H=High

27.1 General Description

Rain harvesting (also referred to as *rain pails* and *rain savers*) are used as a water conservation practice and a stormwater management strategy. Capturing water in a rain tank/barrel prevents runoff from flowing down a driveway or across a parking lot and picking up soil, pesticides, and other pollutants before entering the storm sewer system.

Rain tanks/barrels not only store water, but also help to decrease the water supply demand during the sweltering summer months. Only 1/4 inch of rainfall runoff from the average roof will completely fill the typical barrel. Collection of water from rooftop runoff can provide an ample supply of free 'soft water' containing no chlorine, lime, or calcium. Because it tends to have fewer sediments and dissolved salts than municipal water, rain water is ideal for a multitude of applications, including organic vegetable gardens, planter beds for botanicals, indoor plants, automobile washing, and cleaning household windows. Saving water in this manner will reduce the demand for treated tap water, and save money by lowering the homeowner's monthly bill. Rain water diversion will also help decrease the burden on water treatment facilities and municipal drainage systems during storm events.

A typical rain harvesting design will include a storage container with a hole at the top to allow for flow from a downspout, a sealed lid, an overflow pipe and a spigot at or near the bottom of the barrel. The spigot can be left partially open to detain water or closed to fill the barrel. A screen is often included to control mosquitoes and other insects. Rain tanks/barrels can be connected in series to provide larger volumes of storage. Larger systems for commercial or industrial use can include pumps and filtration systems.

For every inch of rain that falls on a catchment area of 1,000 square feet, approximately 600 gallons of rainwater can be collected. Ten inches of rain falling on a 1,000 square foot catchment area will generate approximately 6,000 gallons of rainwater.

27.2 Design Criteria and Specifications

- The required capacity of a rain barrel is a function of the rooftop surface area that drains to it, the inches of rainfall required to fill the barrel, and water losses due primarily to evaporation. The general rule of thumb to utilize in the sizing of rain barrels is 1 inch of rainfall on a 1000 square foot roof will yield approximately 600 gallons.

Sample Calculation	
Rain barrel volume can be determined by calculating the roof top water yield for any given rainfall, using the following general equation:	
Equation 27.1	$V = A^2 \times R \times 0.90 \times 7.5 \text{ gals./ft.}^3$ where:
V	= volume of rain barrel (gallons)
A^2	= surface area roof (square feet)
R	= rainfall (feet)
0.90	= losses to system (no units)
7.5	= conversion factor (gallons per cubic foot)
<p>Example: one 60-gallon barrel would provide runoff storage from a rooftop area of approximately 212 square feet for a 1.5 inch (0.125 ft.) of rainfall.</p> $V = 212 \text{ ft.}^2 \times 0.125 \text{ ft.} \times 0.90 \times 7.5 \text{ gallons/ft.}^3 = 179 \text{ gallons}$	

- Homeowners and manufacturers typically use a flexible plastic downspout elbow to direct water from the downspout into the rain tank/barrel. It is best to use the downspout connector only for smaller drainage areas or to use a diverter that can be engaged either automatically or with physical contact.
- The use of screens should be considered on gutters and downspouts to remove sediment and particles as the water enters the barrel.
- Containers should be opaque to discourage bacteria/algae growth.
- Most rain barrels are equipped with tight covers and screens to prevent accidents involving children and pets and to keep debris out of the barrels. To combat concerns regarding mosquitoes and West Nile virus, tight fitting screens should be inspected and maintained on a routine basis or nontoxic mosquito control agent (Bti) placed in water.
- A half-barrel design will allow the barrel to sit flush against a building and may prove to be more aesthetically pleasing.
- A typical rain barrel will include spigot at the top to accommodate overflow (this should be directed away from the foundation of the building) and a gravity-fed hose bib at the bottom to connect a hose for redistribution of the rainwater.
- Inexpensive rain barrels can be made from food grade plastic barrels or heavy-duty trash cans, for as little as \$15 or they can be purchased pre-made from numerous non-profit organizations, commercial manufacturers, and retailers, in prices ranging from \$25 to \$150.

27.3 Example Schematics

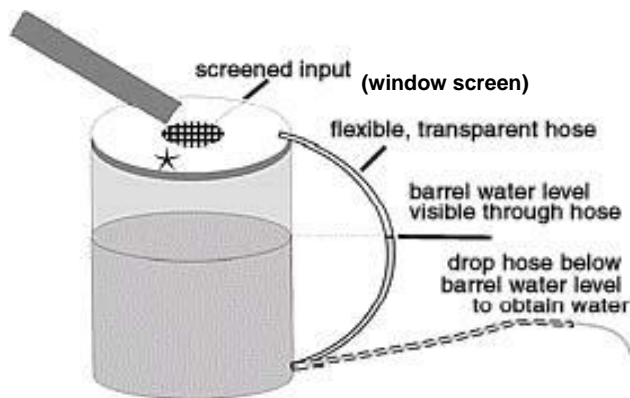

Figure 27.2 Rain barrels in series

Figure 27.1 Simple Rain Barrel Design (from Maryland DNR Green Building Program)



28.0 Stormwater Wetlands

Stormwater Control



Description: Constructed wetland systems used for stormwater management. Runoff volume is both stored and treated in the wetland facility.

KEY CONSIDERATIONS

DESIGN CRITERIA:

- Minimum contributing drainage area of 25 acres; 5 acres for pocket wetland
- Minimum dry weather flow path of 2:1 (length: width) should be provided from inflow to outflow
- Minimum of 35% of total surface area should have a depth of 6 inches or less; 10 to 20% of surface area should be deep pool (1.5- to 6-foot depth)

ADVANTAGES / BENEFITS:

- Good nutrient removal
- Provides natural wildlife habitat
- Relatively low maintenance costs

DISADVANTAGES / LIMITATIONS:

- Requires large land area
- Needs continuous baseflow for viable wetland
- Sediment regulation is critical to sustain wetlands
- Large commitment to establish vegetation in the first 3 years

MAINTENANCE REQUIREMENTS:

- Replace wetland vegetation to maintain at least 50% surface area coverage
- Remove invasive vegetation
- Monitor sediment accumulation and remove periodically

POLLUTANT REMOVAL

80%	Total Suspended Solids
40/30%	*Nutrients - Total Phosphorus / Total Nitrogen removal
50%	Metals - Cadmium, Copper, Lead, and Zinc removal
70%	Pathogens - Coliform, Streptococci, E.Coli removal

STORMWATER MANAGEMENT SUITABILITY

- P** Water Quality Protection
- P** Streambank Protection
- P** On-Site Flood Control*
- P** Downstream Flood Control*

**Does not apply to Submerged Gravel Wetland Systems*

Accepts Hotspot Runoff: Yes
(2 feet of separation distance required to water table)

IMPLEMENTATION CONSIDERATIONS

- M-H** Land Requirement
- M** Capital Cost
- Maintenance Burden:**
 - M** Shallow Wetland
 - M** ED Shallow Wetland
 - H** Pocket Wetland
 - M** Pond/Wetland

Residential Subdivision Use: Yes
High-Density/Ultra-Urban: No
Drainage Area: 25 acres min.
Soils: Hydrologic group 'A' and 'B' soils may require a liner

L=Low M=Moderate H=High

28.1 General Description

Stormwater wetlands (also referred to as constructed wetlands) are constructed shallow marsh systems that are designed to both treat urban stormwater and control runoff volumes. As stormwater runoff flows through the wetland facility, pollutant removal is achieved through settling and uptake by marsh vegetation.

Wetlands are among the most effective stormwater practices in terms of pollutant removal and also offer aesthetic value and wildlife habitat. Constructed stormwater wetlands differ from natural wetland systems in that they are engineered facilities designed specifically for the purpose of treating stormwater runoff and typically have less biodiversity than natural wetlands both in terms of plant and animal life. However, as with natural wetlands, stormwater wetlands require a continuous base flow or a high water table to support aquatic vegetation.

There are several design variations of the stormwater wetland, each design differing in the relative amounts of shallow and deep water, and dry storage above the wetland. These include the shallow wetland, the extended detention shallow wetland, pond/wetland system, and pocket wetland. Figure 28.1 contains photos of various wetlands. Below are descriptions of each design variant:

- **Shallow Wetland** – In the shallow wetland design, most of the water quality treatment volume is in the relatively shallow high marsh or low marsh depths. The only deep portions of the shallow wetland design are the forebay at the inlet to the wetland, and the micropool at the outlet. One disadvantage of this design is that, since the pool is very shallow, a relatively large amount of land is typically needed to store the water quality volume.
- **Extended Detention (ED) Shallow Wetland** – The extended detention (ED) shallow wetland design is the same as the shallow wetland; however, part of the water quality treatment volume is provided as extended detention above the surface of the marsh and released over a period of 24 hours. This design can treat a greater volume of stormwater in a smaller space than the shallow wetland design. In the extended detention wetland option, plants that can tolerate both wet and dry periods need to be specified in the extended detention zone.
- **Pond/Wetland Systems** – The pond/wetland system has two separate cells: a wet pond and a shallow marsh. The wet pond traps sediments and reduces runoff velocities prior to entry into the wetland where stormwater flows receive additional treatment. Less land is required for a pond/wetland system than for the shallow wetland or the extended detention shallow wetland systems.
- **Pocket Wetland** – A pocket wetland is intended for smaller drainage areas of 5 to 10 acres and typically requires excavation down to the water table for a reliable water source to support the wetland system.
- **Submerged Gravel** - Also known as subsurface flow wetlands, this wetland consists of one or more cells filled with crushed rock designed to support wetland plants. Stormwater flows subsurface through the root zone of the constructed wetland where pollutant removal takes place. *This type of wetland is not recommended for use to meet stormwater management goals due to limited performance data.* They may be applicable in special or retrofit situations where there are severe limitations on what can be implemented.



Shallow Wetland



Shallow ED Wetland



Newly Constructed Shallow Wetland



Pocket Wetland



Submerged Gravel Wetland

Figure 28.1 Stormwater Wetland Examples

28.2 Stormwater Management Suitability

Similar to stormwater ponds, stormwater wetlands are designed to control both stormwater quantity and quality. Thus, a stormwater wetland can be used to address all of the integrated stormwater sizing criteria for a given drainage area.

Water Quality

Pollutants are removed from stormwater runoff in a wetland through uptake by wetland vegetation and algae, vegetative filtering, and through gravitational settling in the slow moving marsh flow. Other pollutant removal mechanisms are also at work in a stormwater wetland including chemical and biological decomposition and volatilization. [Section 28.3](#) provides pollutant removal efficiencies that can be used for planning and design purposes.

Streambank Protection

The storage volume above the permanent pool/water surface level in a stormwater wetland is used to provide control of the streambank protection volume (SP_v). This is accomplished by releasing the 1-year, 24-hour storm runoff volume over 24 hours (extended detention). It is best to do this with minimum vertical water level fluctuation, as extreme fluctuation may stress vegetation.

Flood Control

In situations where it is required, stormwater wetlands can also be used to provide detention to control the flood mitigation storm peak flow. Where flood mitigation storm peak control is not required, a stormwater wetland must be designed to safely pass the flood mitigation storm flows.

28.3 Pollutant Removal Capabilities

All of the stormwater wetland design variants are presumed to be able to remove 80% of the total suspended solids load in typical urban post-development runoff when sized, designed, constructed and maintained in accordance with the recommended specifications. Undersized or poorly designed wetland facilities can reduce TSS removal performance.

The following design pollutant removal rates are conservative average pollutant reduction percentages for design purposes derived from sampling data, modeling and professional judgment. In a situation where a removal rate is not deemed sufficient, additional controls may be put in place at the given site in a series or “treatment train” approach.

- Total Suspended Solids – 80%
- Total Phosphorus – 40%
- Total Nitrogen – 30%
- Fecal Coliform – 70% (if no resident waterfowl population present)
- Heavy Metals – 50%

For additional information and data on pollutant removal capabilities for stormwater wetlands, see the National Pollutant Removal Performance Database (2nd Edition) available at www.cwp.org and the National Stormwater Best Management Practices (BMP) Database at www.bmpdatabase.org

Submerged Gravel Wetland

The pollution removal efficiency of the submerged gravel wetland is similar to a typical wetland. Recent data show a TSS removal rate in excess of the 80% goal. This reflects the settling environment of the gravel media. These systems also exhibit removals of about 60% TP, 20% TN, and 50% Zn. The growth of algae and microbes among the gravel media has been determined to be the primary removal mechanism of the submerged gravel wetland.

The following design pollutant removal rates are conservative average pollutant reduction percentages for design purposes derived from sampling data, modeling and professional judgment.

- Total Suspended Solids – 80%
- Total Phosphorus – 50%
- Total Nitrogen – 20%
- Fecal Coliform – 70%
- Heavy Metals – 50%

Although gravel wetlands are fairly effective at removing total phosphorus, they have a tendency to contribute small amounts of soluble phosphorus.

28.4 Application and Site Feasibility Criteria

Stormwater wetlands are generally applicable to most types of new development and redevelopment, and can be utilized in both residential and nonresidential areas. However, due to the large land requirements, wetlands may not be practical in higher density areas. The following criteria should be evaluated to ensure the suitability of a stormwater wetland for meeting stormwater management objectives on a site or development.

General Feasibility

- Suitable for Residential Subdivision Usage – YES
- Suitable for High Density/Ultra Urban Areas – Land requirements may preclude use
- Regional Stormwater Control – YES
- Hot Spot Runoff - YES

Physical Feasibility - Physical Constraints at Project Site

- Drainage Area – A minimum of 25 acres and a positive water balance is needed to maintain wetland conditions; 5 acres for pocket wetland
- Space Required – Approximately 3 to 5% of the tributary drainage area
- Site Slope – There should be no more than 8% slope across the wetland site
- Minimum Head – Elevation difference needed at a site from the inflow to the outflow: 3 to 5 feet; 2 to 3 feet for pocket wetland
- Minimum Depth to Water Table – If used on a site with an underlying water supply aquifer or when treating a hotspot, a separation distance of 2 feet is recommended between the bottom of the wetland and the elevation of the seasonally high water table; pocket wetland is typically below water table.
- Soils – Permeable soils are not well suited for a constructed stormwater wetland without a high water table. Underlying soils of hydrologic group “C” or “D” should be adequate to maintain wetland conditions. Most group “A” soils and some group “B” soils will require a liner. *Evaluation of soils should be based upon an actual subsurface analysis and permeability tests.*

28.5 Planning and Design Criteria

*The following criteria are to be considered **minimum** standards for the design of a stormwater wetland facility. Consult with the local review authority to determine if there are any variations to these criteria or additional standards that must be followed.*

A Location and Siting

Stormwater wetlands should normally have a minimum contributing drainage area of 25 acres or more. For a pocket wetland, the minimum drainage area is 5 acres.

A continuous base flow or high water table is required to support wetland vegetation. A water balance must be performed to demonstrate that a stormwater wetland can withstand a 30-day drought at summer

evaporation rates without completely drawing down (see [Section 4.0 of the Hydrology Technical Manual](#) for details).

Wetland siting should also take into account the location and use of other site features such as natural depressions, buffers, and undisturbed natural areas, and should attempt to aesthetically “fit” the facility into the landscape. Bedrock close to the surface may prevent excavation.

Stormwater wetlands cannot be located within navigable waters of the U.S., including natural wetlands, without obtaining a Section 404 permit under the Clean Water Act, and any other applicable State permit. In some isolated cases, a wetlands permit may be granted to convert an existing degraded wetland in the context of local watershed restoration efforts.

If a wetland facility is not used for flood control less than the 100 year event, it should be designed as an off-line system to bypass higher flows rather than passing them through the wetland system.

Minimum setback requirements for stormwater wetland facilities (when not specified by local ordinance or criteria):

- From a property line – 10 feet
- From a private well – 100 feet; if well is downgradient from a hotspot land use then the minimum setback is 250 feet
- From a septic system tank/leach field/spray area – 50 feet

All utilities should be located outside of the wetland site.

B General Design

A well-designed stormwater wetland consists of:

1. Shallow marsh areas of varying depths with wetland vegetation,
2. Permanent micropool, and
3. Overlying zone in which runoff control volumes are stored.

Pond/wetland systems also include a stormwater pond facility (see [Section 22.0](#), for pond design information).

In addition, all wetland designs must include a sediment forebay at the inflow to the facility to allow heavier sediments to drop out of suspension before the runoff enters the wetland marsh.

Additional wetland design features include an emergency spillway, maintenance access, safety bench, wetland buffer, and appropriate wetland vegetation and native landscaping.

Figures 28.3 through 28.6 in [Section 28.8](#) provide plan view and profile schematics for the design of a shallow wetland, extended detention shallow wetland, pond/wetland system, and pocket wetland, respectively.

C Physical Specifications / Geometry

In general, wetland designs are unique for each site and application. However, there are a number of geometric ratios and limiting depths for the design of a stormwater wetland that must be observed for adequate pollutant removal, ease of maintenance, and improved safety. Table 28.1 provides the recommended physical specifications and geometry for the various stormwater wetland design variants.

Design Criteria	Shallow Wetland	ED Shallow Wetland	Pond/Wetland	Pocket Wetland
Length to Width Ratio (minimum)	2:1	2:1	2:1	2:1
Extended Detention (ED)	No	Yes	Optional	Optional
Allocation of WQ _v Volume (pool/marsh/ED) in %	25/75/0	25/25/50	70/30/0 (includes pond volume)	25/75/0
Allocation of Surface Area (deepwater/low marsh/high marsh/semi-wet) in %	20/35/40/5	10/35/45/10	45/25/25/5 (includes pond surface area)	10/45/40/5
Forebay	Required	Required	Required	Required
Micropool	Required	Required	Required	Required
Outlet Configuration	Reverse-slope pipe or hooded broad-crested weir	Reverse-slope pipe or hooded broad-crested weir	Reverse-slope pipe or hooded broad-crested weir	Hooded broad-crested weir

The stormwater wetland should be designed with the recommended proportion of “depth zones.” Each of the four wetland design variants has depth zone allocations which are given as a percentage of the stormwater wetland surface area. Target allocations are found in Table 28.1. The four basic depth zones are:

- **Deepwater zone**
From 1.5 to 6 feet deep. Includes the outlet micropool and deepwater channels through the wetland facility. This zone supports little emergent wetland vegetation, but may support submerged or floating vegetation.
- **Low marsh zone**
From 6 to 18 inches below the normal permanent pool or water surface elevation. This zone is suitable for the growth of several emergent wetland plant species.
- **High marsh zone**
From 6 inches below the pool to the normal pool elevation. This zone will support a greater density and diversity of wetland species than the low marsh zone. The high marsh zone should have a higher surface area to volume ratio than the low marsh zone.
- **Semi-wet zone**
Those areas above the permanent pool that are inundated during larger storm events. This zone supports a number of species that can survive flooding.

A minimum dry weather flow path of 2:1 (length to width) is required from inflow to outlet across the stormwater wetland and should ideally be greater than 3:1. This path may be achieved by constructing internal dikes or berms, using marsh plantings, and by using multiple cells. Finger dikes are commonly used in surface flow systems to create serpentine configurations and prevent short-circuiting. Microtopography (contours along the bottom of a wetland or marsh that provide a variety of conditions for different species needs and increases the surface area to volume ratio) is encouraged to enhance wetland diversity.

A 4- to 6-foot deep micropool must be included in the design at the outlet to prevent the outlet from clogging and resuspension of sediments, and to mitigate thermal effects.

Maximum depth of any permanent pool areas should generally not exceed 6 feet.

The volume of the extended detention must not comprise more than 50% of the total WQ_v , and its maximum water surface elevation must not extend more than 3 feet above the normal pool. Q_p and/or SP_v storage can be provided above the maximum WQ_v elevation within the wetland.

The perimeter of all deep pool areas (4 feet or greater in depth) should be surrounded by safety and aquatic benches similar to those for stormwater ponds (see [Section 22.0](#)).

The contours of the wetland should be irregular to provide a more natural landscaping effect.

D Submerged Gravel Wetlands

Submerged gravel wetlands should be designed as off-line systems designed to handle only water quality volume.

Submerged gravel wetland systems need sufficient drainage area to maintain vegetation. See [Section 4.0 of the Hydrology Technical Manual](#) for guidance on performing a water balance calculation.

The local slope should be relatively flat (<2%). While there is no minimum slope requirement, there does need to be enough elevation drop from the inlet to the outlet to ensure that hydraulic conveyance by gravity is feasible (generally about 3 to 5 feet).

A design maximum depth of 16 inches of water at the inlet is recommended, with a total gravel depth of 20 inches.

Gravel should be 0.5-1.0 inch in size.

Darcy's Law may be used to estimate flows in the gravel media, although the use of predesign tests with the actual gravel will refine the "effective" hydraulic conductivity.

The initial design should not utilize more than 70 percent of the potential hydraulic gradient available in the proposed bed to allow a safety factor for clogging.

Using a value of $< 113 \text{ m}^3/\text{m}^2/\text{d}$ for the "effective" hydraulic conductivity (k_s) in the design will also help account for potential clogging.

An adjustable outlet is recommended to ensure adequate hydraulic gradient and prevent surface flow from occurring and shortcircuiting treatment within the gravel media.

Washed stone or gravel, should be specified to protect against an accumulation of fine material that could cause hydraulic blockages.

All submerged gravel wetland designs should include a sediment forebay or other equivalent pretreatment measures to prevent sediment or debris from entering and clogging the gravel bed.

Unless they receive hotspot runoff, submerged gravel wetland systems can be allowed to intersect the groundwater table.

Guidance on establishing wetland vegetation can be found in the [Landscape Technical Manual](#).

E Pretreatment / Inlets

Sediment regulation is critical to sustain stormwater wetlands. A wetland facility should have a sediment forebay or equivalent upstream pretreatment. A sediment forebay is designed to remove incoming sediment from the stormwater flow prior to dispersal into the wetland. The forebay should consist of a separate cell, formed by an acceptable barrier. A forebay is to be provided at each inlet, unless the inlet provides less than 10% of the total design storm inflow to the wetland facility.

The forebay is sized to contain 0.1 inches per impervious acre of contributing drainage and should be 4 to 6 feet deep. The pretreatment storage volume is part of the total WQ_v requirement and may be subtracted from WQ_v for wetland storage sizing.

A fixed vertical sediment depth marker shall be installed in the forebay to measure sediment deposition over time. The bottom of the forebay may be hardened (e.g., using concrete, paver blocks, etc.) to make sediment removal easier.

Inflow channels are to be stabilized with flared riprap aprons, or the equivalent. Inlet pipes to the pond can be partially submerged. Inflow pipe, channel velocities and exit velocities from the forebay must be nonerosive.

F Outlet Structures

- Flow control from a stormwater wetland is typically accomplished with the use of a concrete or corrugated aluminum, aluminized steel, or HDPE riser and barrel. The riser is a vertical pipe or inlet structure that is attached to the base of the micropool with a watertight connection. The outlet barrel is a horizontal pipe attached to the riser that conveys flow under the embankment (see Figure 28.2). The riser should be located within the embankment for maintenance access, safety, and aesthetics.
- A number of outlets at varying depths in the riser provide internal flow control for routing of the water quality protection, streambank protection, and flood control runoff volumes. The number of orifices can vary and is usually a function of the pond design.

For shallow and pocket wetlands, the riser configuration is typically comprised of a streambank protection outlet (usually an orifice) and flood control outlet (often a slot or weir). The streambank protection orifice is sized to release the streambank protection storage volume over a 24-hour period (12-hour extended detention may be warranted in some cold water streams). Since the water quality volume is fully contained in the permanent pool, no orifice sizing is necessary for this volume. As runoff from a water quality event enters the wet pond, it simply displaces that same volume through the streambank protection orifice. Thus an off-line shallow or pocket wetland providing only water quality treatment can use a simple overflow weir as the outlet structure.

In the case of a extended detention (ED) shallow wetland, there is generally a need for an additional outlet (usually an orifice) that is sized to pass the extended detention water quality volume that is surcharged on top of the permanent pool. Flow will first pass through this orifice, which is sized to release the water quality extended detention volume in 24 hours. The preferred design is a reverse slope pipe attached to the riser, with its inlet submerged 1 foot below the elevation of the permanent pool to prevent floatables from clogging the pipe and to avoid discharging warmer water at the surface of the pond. The next outlet is sized for the release of the streambank protection storage volume. The outlet (often an orifice) invert is located at the maximum elevation associated with the extended detention water quality volume and is sized to release the streambank protection storage volume over a 24-hour period (12-hour extended detention may be warranted in some cold water streams).

Alternative hydraulic control methods to an orifice can be used and include the use of a broad-crested rectangular, V-notch, proportional weir, or an outlet pipe protected by a hood that extends at least 12 inches below the normal pool.

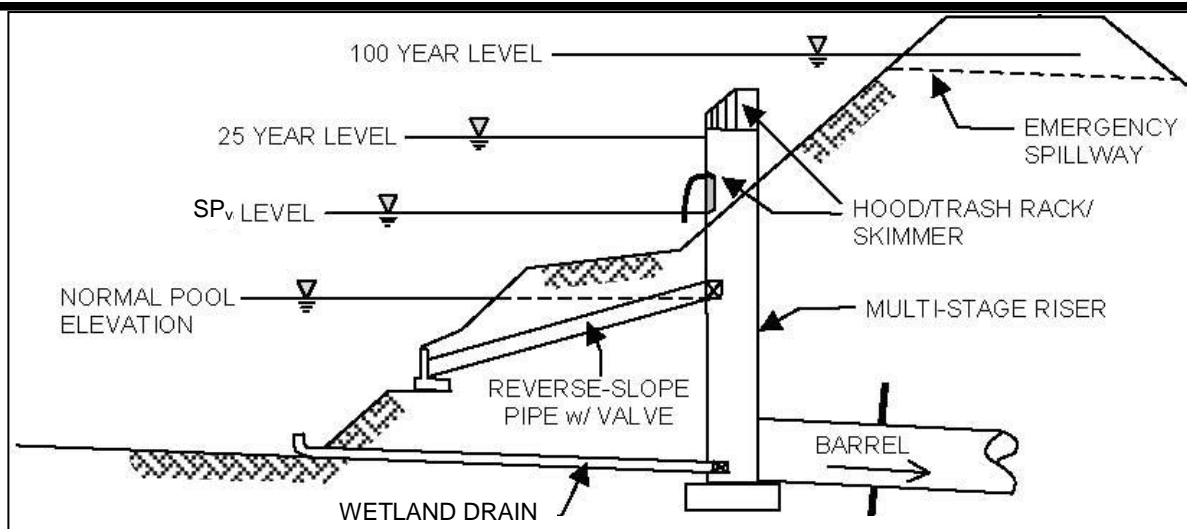

Figure 28.2 Typical Wetland Facility Outlet Structure

- The water quality outlet (if design is for an extended detention shallow wetland) and streambank protection outlet should be fitted with adjustable gate valves or other mechanism that can be used to adjust detention time.
- Higher flows pass through openings or slots protected by trash racks further up on the riser.
- After entering the riser, flow is conveyed through the barrel and is discharged downstream. Anti-seep collars should be installed on the outlet barrel to reduce the potential for pipe failure.
- Riprap, plunge pools or pads, or other energy dissipators are to be placed at the outlet of the barrel to prevent scouring and erosion. If a wetland facility daylights to a channel with dry weather flow, care should be taken to minimize tree clearing along the downstream channel, and to reestablish a forested riparian zone in the shortest possible distance. See [Section 6.0 of the Hydraulic Technical Manual](#) for more guidance.
- The wetland facility must have a bottom drain pipe located in the micropool with an adjustable valve that can completely or partially dewater the wetland within 24 hours.
- The wetland drain should be sized one pipe size greater than the calculated design diameter. The drain valve is typically a handwheel activated knife or gate valve. Valve controls shall be located inside of the riser at a point where they (a) will not normally be inundated and (b) can be operated in a safe manner.

See the design procedures in [Sections 2.0 and 2.2 of the Hydraulics Technical Manual](#) for additional information and specifications on pond routing and outlet works.

G. Emergency Spillway

An emergency spillway is to be included in the stormwater wetland design to safely pass flows that exceed the design storm flows. The spillway prevents the wetland's water levels from overtopping the embankment and causing structural damage. The emergency spillway must be located so that downstream structures will not be impacted by spillway discharges.

A minimum of 1 foot of freeboard must be provided, measured from the top of the water surface elevation for the flood mitigation storm to the lowest point on top of the dam, not counting the emergency spillway.

H Maintenance Access

A maintenance right of way or easement must be provided to the wetland facility from a public road or easement. Maintenance access should be at least 12 feet wide, have a maximum slope of no more than 15%, and be appropriately stabilized to withstand maintenance equipment and vehicles.

The maintenance access must extend to the forebay, safety bench, riser, and outlet and, to the extent feasible, be designed to allow vehicles to turn around.

Access to the riser is to be provided by lockable manhole covers, and manhole steps within easy reach of valves and other controls.

I Safety Features

All embankments and spillways must be designed to State of Texas Administrative Code for dams and reservoirs (see *iSWM Program Guidance – Dams and Reservoirs in Texas*).

Fencing of wetlands is not generally desirable, but may be required by the local review authority. A preferred method is to manage the contours of deep pool areas through the inclusion of a safety bench (see above) to eliminate dropoffs and reduce the potential for accidental drowning.

The principal spillway opening should not permit access by small children, and endwalls above pipe outfalls greater than 48 inches in diameter should be fenced to prevent a hazard.

J Landscaping

A landscaping plan should be provided that indicates the methods used to establish and maintain wetland coverage. Minimum elements of a plan include: delineation of landscaping zones, selection of corresponding plant species, planting plan, sequence for preparing wetland bed (including soil amendments, if needed), and sources of plant material.

Landscaping zones include low marsh, high marsh, and semi-wet zones. The low marsh zone ranges from 6 to 18 inches below the normal pool. This zone is suitable for the growth of several emergent plant species. The high marsh zone ranges from 6 inches below the pool up to the normal pool. This zone will support greater density and diversity of emergent wetland plant species. The high marsh zone should have a higher surface area to volume ratio than the low marsh zone. The semi-wet zone refers to those areas above the permanent pool that are inundated on an irregular basis and can be expected to support wetland plants.

The landscaping plan should provide elements that promote greater wildlife and waterfowl use within the wetland and buffers.

Woody vegetation may not be planted on a dam embankment or allowed to grow within 15 feet of the toe of the dam and 25 feet from the principal spillway structure.

A wetland buffer shall extend 25 feet outward from the maximum water surface elevation, with an additional 15-foot setback to structures. The wetland buffer should be contiguous with other buffer areas that are required by existing regulations (e.g., stream buffers) or that are part of the overall stormwater management concept plan. No structures should be located within the buffer, and an additional setback to permanent structures may be provided.

Existing trees should be preserved in the buffer area during construction. It is desirable to locate forest conservation areas adjacent to ponds. To discourage resident water fowl populations, the buffer can be planted with trees, shrubs and native ground covers.

The soils of a wetland buffer are often severely compacted during the construction process to ensure stability. The density of these compacted soils is so great that it effectively prevents root penetration and therefore may lead to premature mortality or loss of vigor. Consequently, it is advisable to excavate large and deep holes around the proposed planting sites and backfill these with uncompacted topsoil.

Guidance on establishing wetland vegetation can be found in the *Landscape Technical Manual*.

K Additional Site-Specific Design Criteria and Issues

Physiographic Factors - Local terrain design constraints

- Low Relief – Providing wetland drain can be problematic
- High Relief – Embankment heights restricted
- Karst – Requires poly or clay liner to sustain a permanent pool of water and protect aquifers; limits on ponding depth; geotechnical tests may be required

Soils

Hydrologic group “A” soils and some group “B” soils may require liner (not relevant for pocket wetland)

Special Downstream Watershed Considerations

- Local Aquatic Habitat – Design wetland offline and provide shading to reduce thermal impact; limit WQ_v -ED to 12 hours
- Aquifer Protection – Prevent possible groundwater contamination by preventing infiltration of hotspot runoff. May require liner for type “A” soils; Pretreat hotspots; 2 to 4 foot separation distance from water table.

28.6 Design Procedures

Step 1 Compute runoff control volumes from the *integrated* Design Focus Areas

Calculate the Water Quality Volume (WQ_v), Streambank protection Volume (SP_v), and the flood mitigation storm Flood Discharge, (for ED wetlands the design volume should be increased by 15%).

Details on the *integrated* Design Focus Areas are found in [Section 1.0 of the Planning Technical Manual](#).

Step 2 Determine if the development site and conditions are appropriate for the use of a stormwater wetland

Consider the Application and Site Feasibility Criteria in [Sections 28.4 and 28.5 \(A\)](#) (Location and Siting).

Step 3 Confirm local design criteria and applicability

Consider any special site-specific design conditions/criteria from [Section 28.5 \(K\)](#) (Additional Site-Specific Design Criteria and Issues).

Check with local officials and other agencies to determine if there are any additional restrictions and/or surface water or watershed requirements that may apply.

Step 4 Determine pretreatment volume

A sediment forebay is provided at each inlet, unless the inlet provides less than 10% of the total design storm inflow to the pond. The forebay should be sized to contain 0.1 inches per impervious acre of contributing drainage and should be 4 to 6 feet deep. The forebay storage volume counts toward the total WQ_v requirement and may be subtracted from the WQ_v for subsequent calculations.

Step 5 Allocate the WQ_v volume among marsh, micropool, and extended detention volumes

Use recommended criteria from Table 28.1.

Step 6 Determine wetland location and preliminary geometry, including distribution of wetland depth zones

This step involves initially laying out the wetland design and determining the distribution of wetland surface area among the various depth zones (high marsh, low marsh, and deepwater). Set WQ_v permanent pool elevation (and WQ_v -ED elevation for extended detention shallow wetland) based on volumes calculated earlier.

See [Section 28.5 \(C\)](#) (Physical Specification / Geometry) for more details.

Step 7 Compute extended detention orifice release rate(s) and size(s), and establish SP_v elevation

Shallow Wetland and Pocket Wetland: The SP_v elevation is determined from the stage-storage relationship and the orifice is then sized to release the streambank protection storage volume over a 24-hour period (12-hour extended detention may be warranted in some cold water streams). The streambank protection orifice should have a minimum diameter of 3 inches and

should be adequately protected from clogging by an acceptable external trash rack. A reverse slope pipe attached to the riser, with its inlet submerged 1 foot below the elevation of the permanent pool is a recommended design. The orifice diameter may be reduced to 1 inch if internal orifice protection is used (i.e., an over-perforated vertical stand pipe with ½-inch orifices or slots that are protected by wirecloth and a stone filtering jacket). Adjustable gate valves can also be used to achieve this equivalent diameter.

ED Shallow Wetland: Based on the elevations established in Step 6 for the extended detention portion of the water quality volume, the water quality orifice is sized to release this extended detention volume in 24 hours. The water quality orifice should have a minimum diameter of 3 inches, and should be adequately protected from clogging by an acceptable external trash rack. A reverse slope pipe attached to the riser, with its inlet submerged one foot below the elevation of the permanent pool, is a recommended design. Adjustable gate valves can also be used to achieve this equivalent diameter. The SP_v elevation is then determined from the stage-storage relationship. The invert of the streambank protection orifice is located at the water quality extended detention elevation, and the orifice is sized to release the streambank protection storage volume over a 24-hour period (12-hour extended detention may be warranted in some cold water streams).

Step 8 Calculate the intermediate flood control release rate and water surface elevation

Set up a stage-storage-discharge relationship for the control structure for the extended detention orifice(s) and the flood control storm.

Step 9 Design embankment(s) and spillway(s)

Size emergency spillway, calculate flood mitigation stormwater surface elevation, set top of embankment elevation, and analyze safe passage of the flood mitigation storm event (Q_f).

At final design, provide safe passage for the flood mitigation storm event. Attenuation may not be required.

Step 10 Investigate potential pond/wetland hazard classification

The design and construction of stormwater management ponds and wetlands are required to follow the latest version of the State of Texas Administrative Code for dams and reservoirs (see [iSWM Program Guidance – Dams and Reservoirs in Texas](#)).

Step 11 Design inlets, sediment forebay(s), outlet structures, maintenance access, and safety features.

See [Section 28.5](#) (E) through (I) for more details.

Step 12 Prepare Vegetation and Landscaping Plan

A landscaping plan for the wetland facility and its buffer should be prepared to indicate how aquatic and terrestrial areas will be stabilized and established with vegetation.

See [Section 28.5](#) (J) (Landscaping) and the [Landscape Technical Manual](#) for more details.

28.7 Inspection and Maintenance Requirements

Table 28.2 Typical Maintenance Activities for Wetlands (Adapted from WMI, 1997 and CWP, 1998)	
Constructed Wetland Systems	
Activity	Schedule
<ul style="list-style-type: none"> Replace wetland vegetation to maintain at least 50% surface area coverage in wetland plants after the second growing season. 	One-Time Activity
<ul style="list-style-type: none"> Clean and remove debris from inlet and outlet structures. Mow side slopes. 	Frequently (3 to 4 times/year)
<ul style="list-style-type: none"> Monitor wetland vegetation and perform replacement planting as necessary. 	Semi-annual Inspection (first 3 years)
<ul style="list-style-type: none"> Examine stability of the original depth zones and microtopographical features. Inspect for invasive vegetation, and remove where possible. Inspect for damage to the dam and inlet/outlet structures. Repair as necessary. Note signs of hydrocarbon build-up, and remove appropriately Monitor for sediment accumulation in the facility and forebay. • Examine to ensure that inlet and outlet devices are free of debris and operational. 	Annual Inspection
<ul style="list-style-type: none"> Repair undercut or eroded areas. 	As Needed
<ul style="list-style-type: none"> Harvest wetland plants that have been “choked out” by sediment build-up. 	Annually
<ul style="list-style-type: none"> Removal of sediment from the forebay 	5 to 7 years or after 50% of the total forebay capacity has been lost
<ul style="list-style-type: none"> Monitor sediment accumulations, and remove sediment when the pool volume has become reduced significantly, plants are “choked” with sediment, or the wetland becomes eutrophic. 	10 to 20 years or after 25% of the wetland volume has been lost
<ul style="list-style-type: none"> Ensure that inlets and outlets to each submerged gravel wetland cell are free from debris and not clogged. Check for sediment buildup in gravel bed. 	Monthly Annual inspection
<ul style="list-style-type: none"> If sediment buildup is preventing flow through the wetland, remove gravel and sediment from cell. Replace with clean gravel and replant vegetation. 	As needed
<ul style="list-style-type: none"> Although there is less evaporation with a submerged as opposed to a surface wetland, supplemental water may be required during long periods without stormwater input. 	As needed
<ul style="list-style-type: none"> Routine maintenance of the vegetation (including harvesting) is not required, although weeds can be controlled by flooding the surface after planting and during early part of growing season. 	As needed

Additional Maintenance Considerations and Requirements

- Maintenance requirements for constructed wetlands are particularly high while vegetation is being established. Monitoring during these first years is crucial to the future success of the wetland as a stormwater structural control. Wetland facilities should be inspected after major storms (greater than 2 inches of rainfall) during the first year of establishment to assess bank stability, erosion damage, flow channelization, and sediment accumulation within the wetland. For the first 3 years, inspections should be conducted at least twice a year.

- A sediment marker should be located in the forebay to determine when sediment removal is required.
- Accumulated sediments will gradually decrease wetland storage and performance. The effects of sediment deposition can be mitigated by the removal of the sediments.
- Sediments excavated from stormwater wetlands that do not receive runoff from designated hotspots are not considered toxic or hazardous material and can be safely disposed of by either land application or landfilling. Sediment testing may be required prior to sediment disposal when a hotspot land use is present. Sediment removed from stormwater wetlands should be disposed of according to an approved erosion and sediment control plan.
- Periodic mowing of the wetland buffer is only required along maintenance rights-of-way and the embankment. The remaining buffer can be managed as a meadow (mowing every other year) or forest.



Regular inspection and maintenance is critical to the effective operation of stormwater wetlands as designed. Maintenance responsibility for a wetland facility and its buffer should be vested with a responsible authority by means of a legally binding and enforceable maintenance agreement that is executed as a condition of plan approval.

28.8 Example Schematics

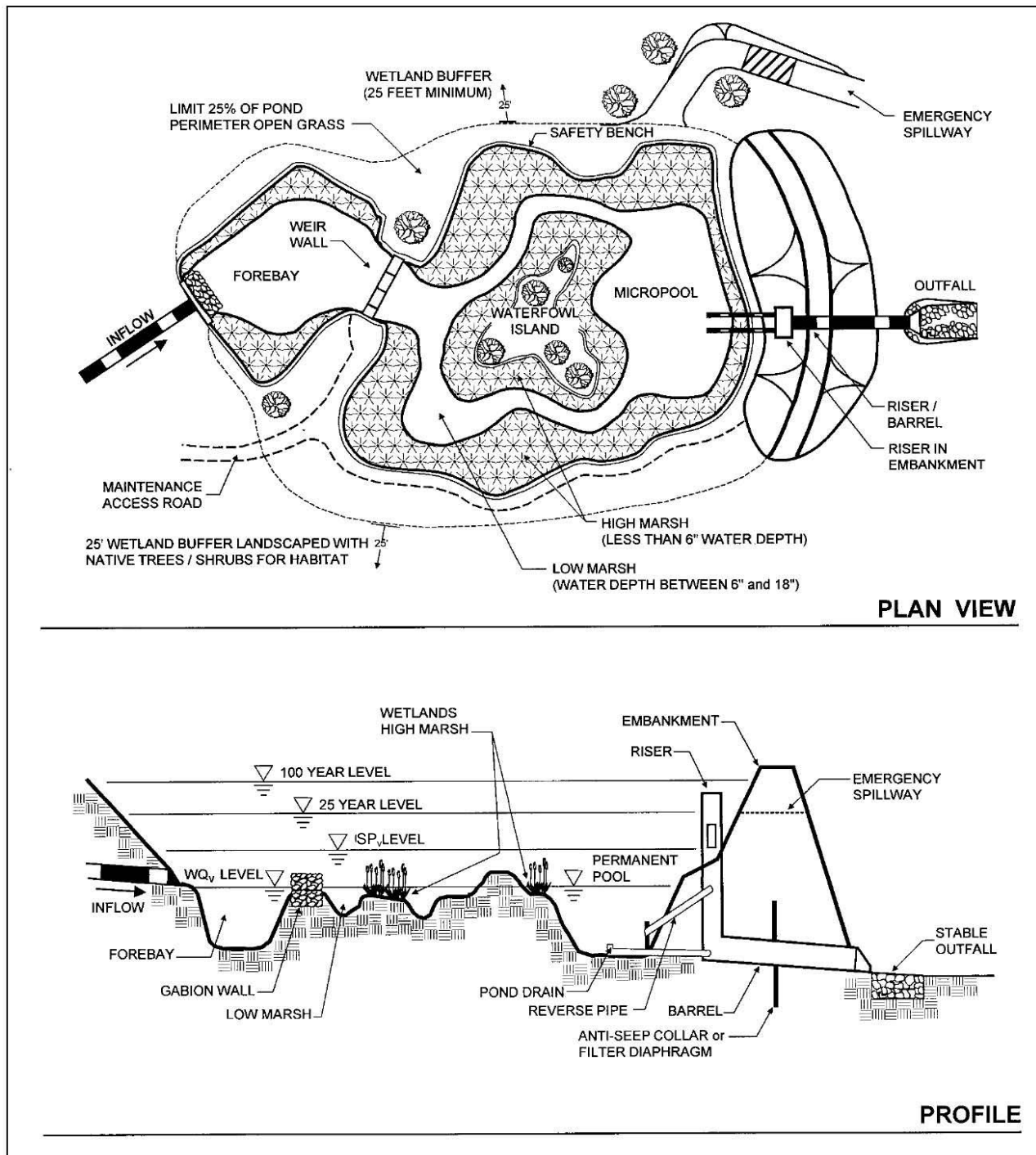

Figure 28.3 Schematic of Shallow Wetland
 (Source: Center for Watershed Protection)

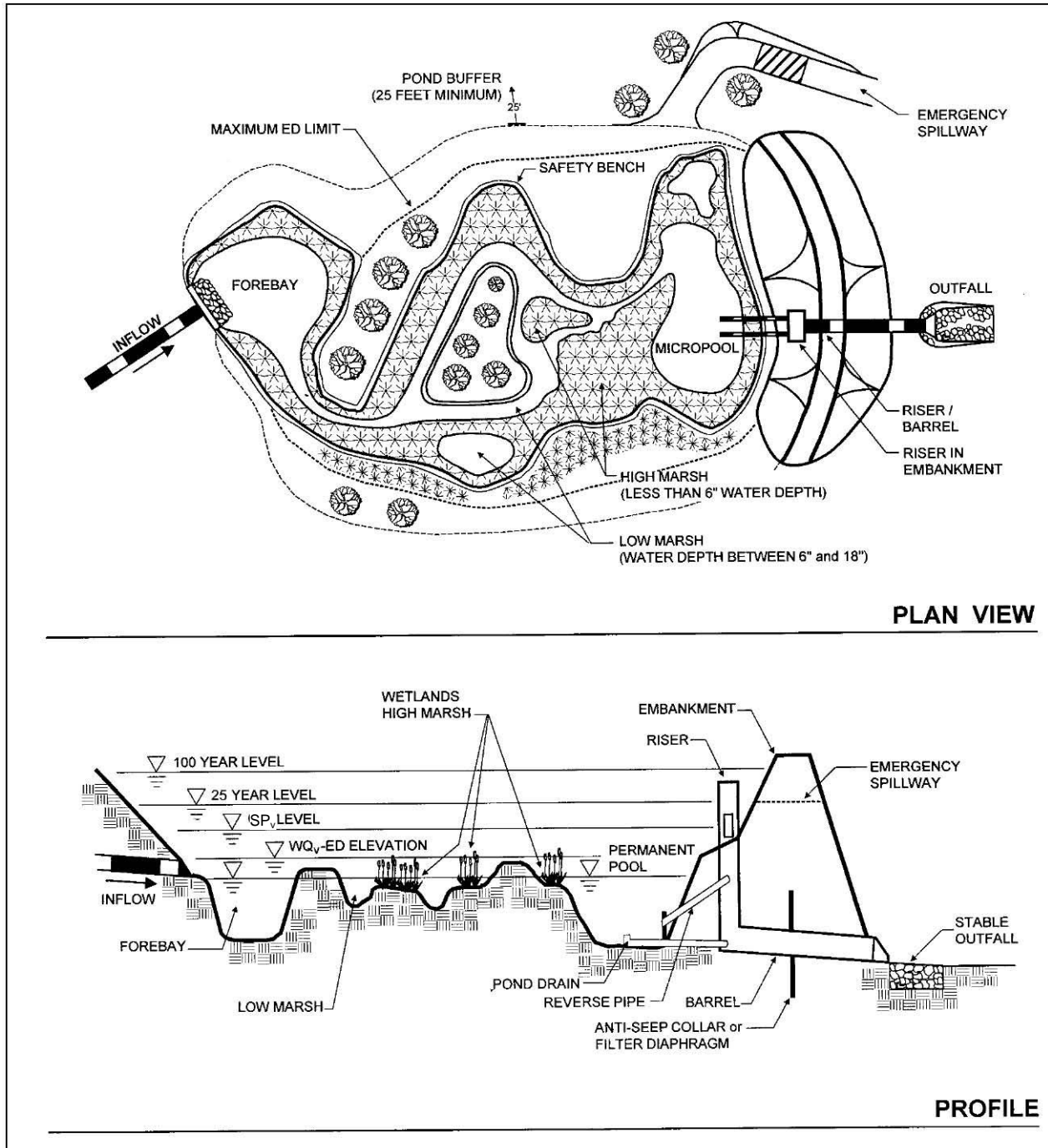

Figure 28.4 Schematic of Extended Detention Shallow Wetland
 (Source: Center for Watershed Protection)

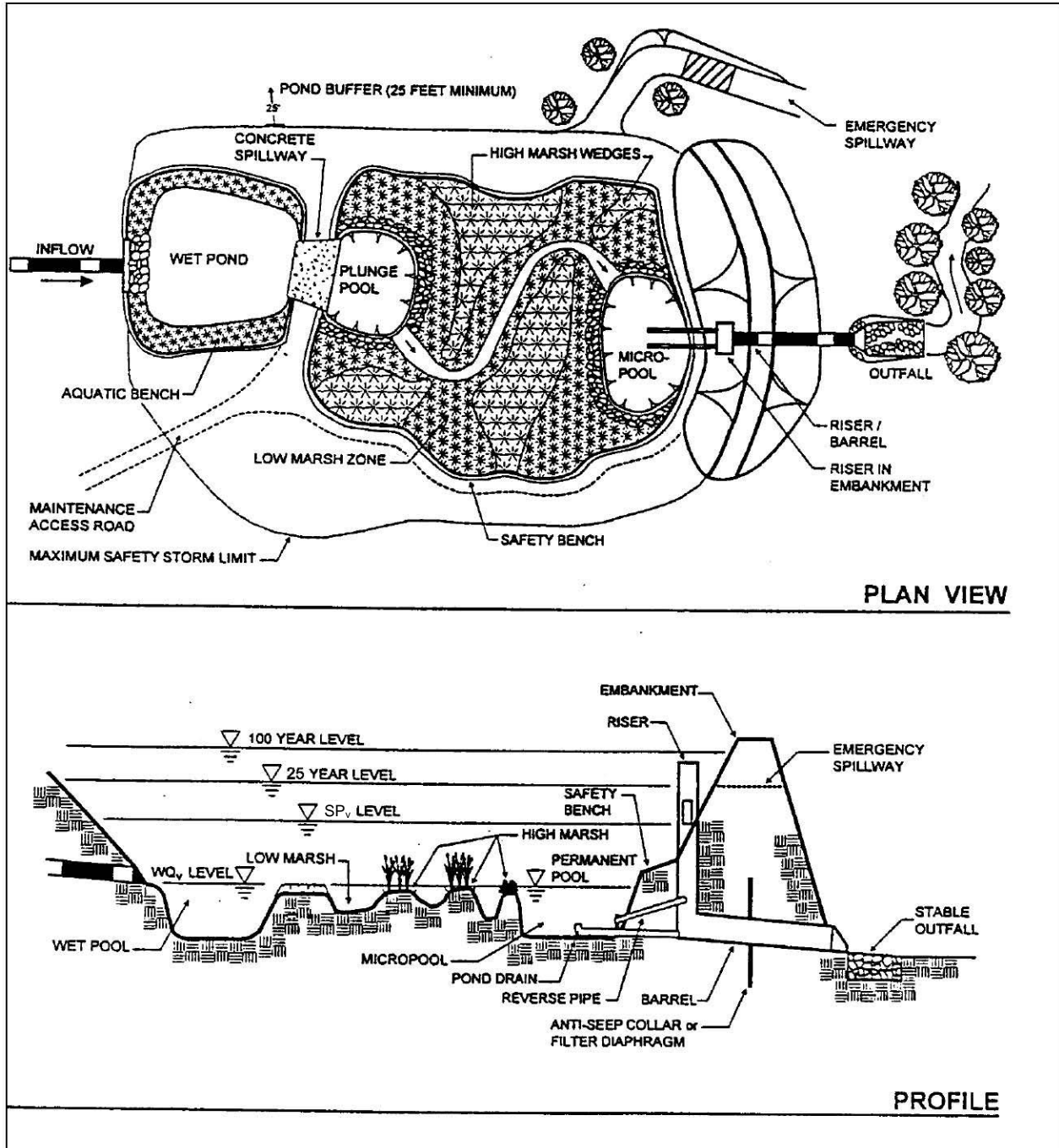

Figure 28.5 Schematic of Pond/Wetland System
(Source: Center for Watershed Protection)

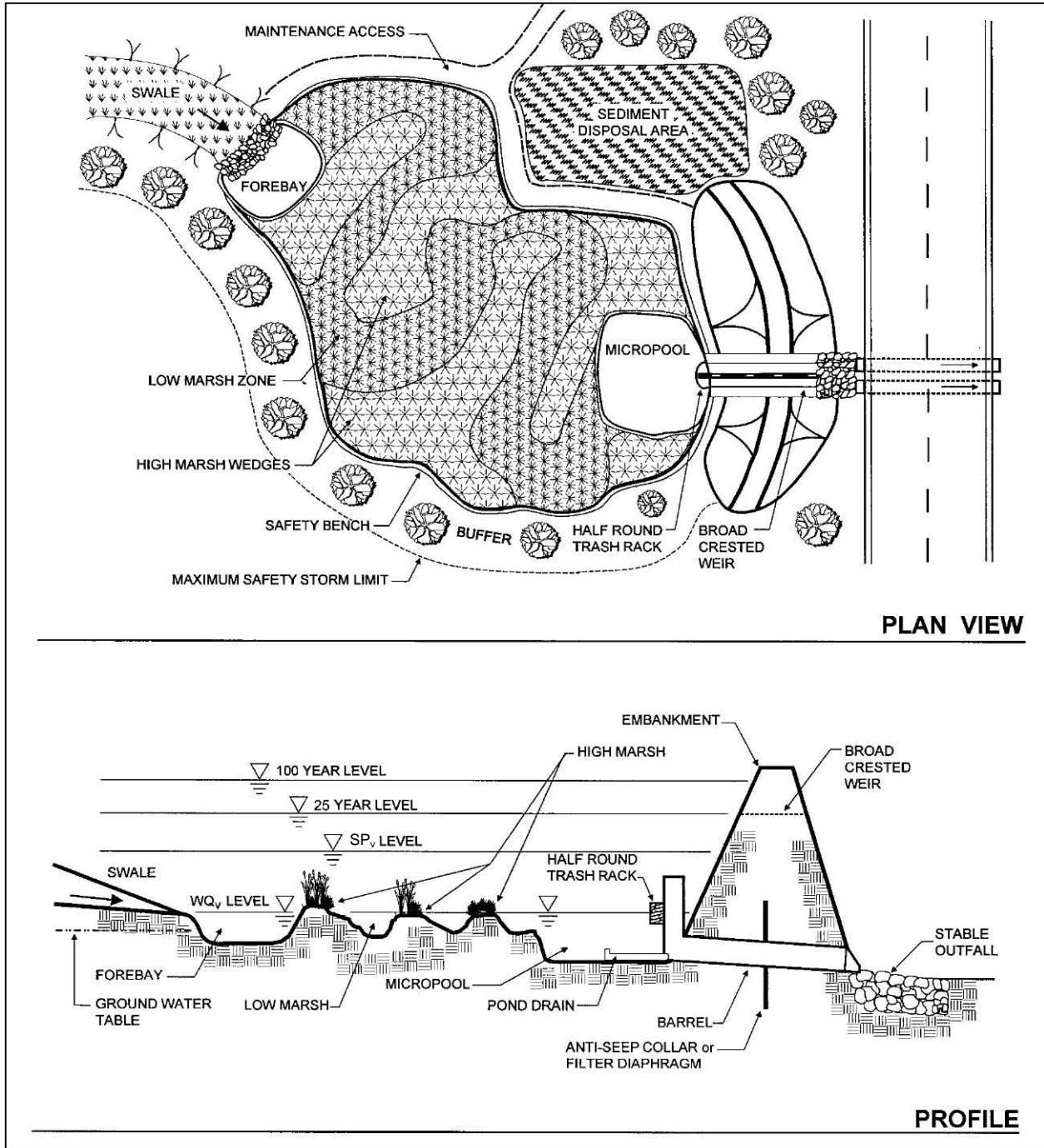

Figure 28.6 Schematic of Pocket Wetland
 (Source: Center for Watershed Protection)

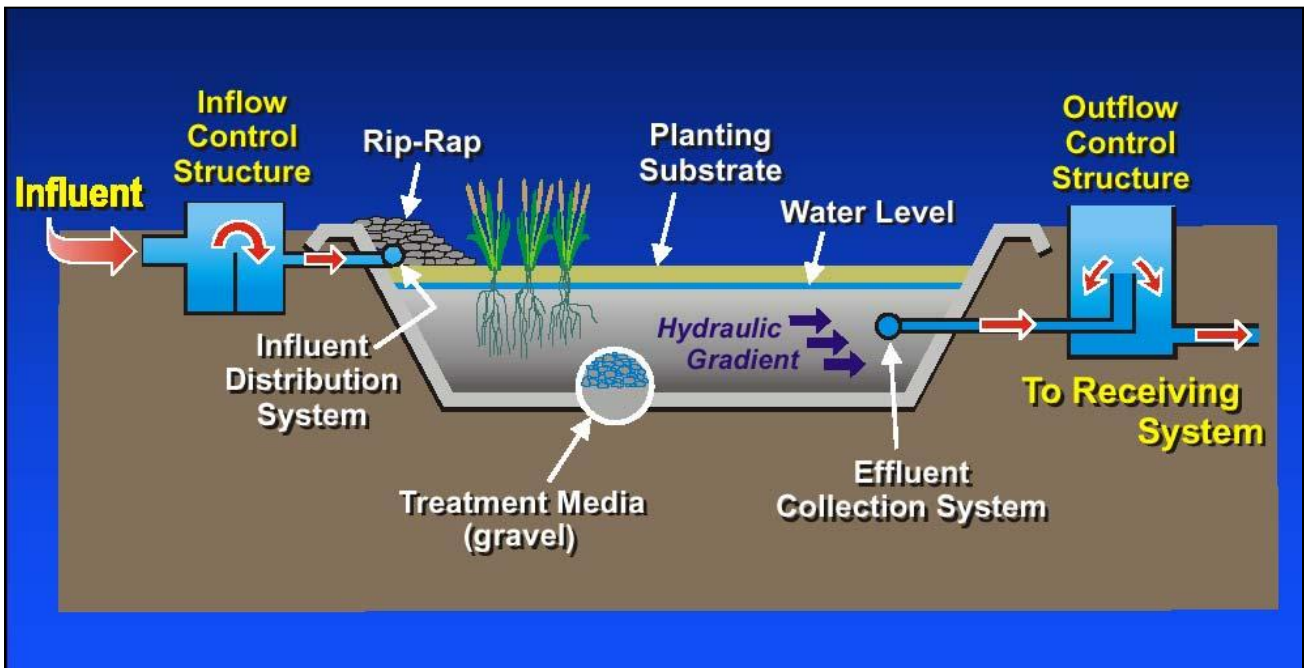
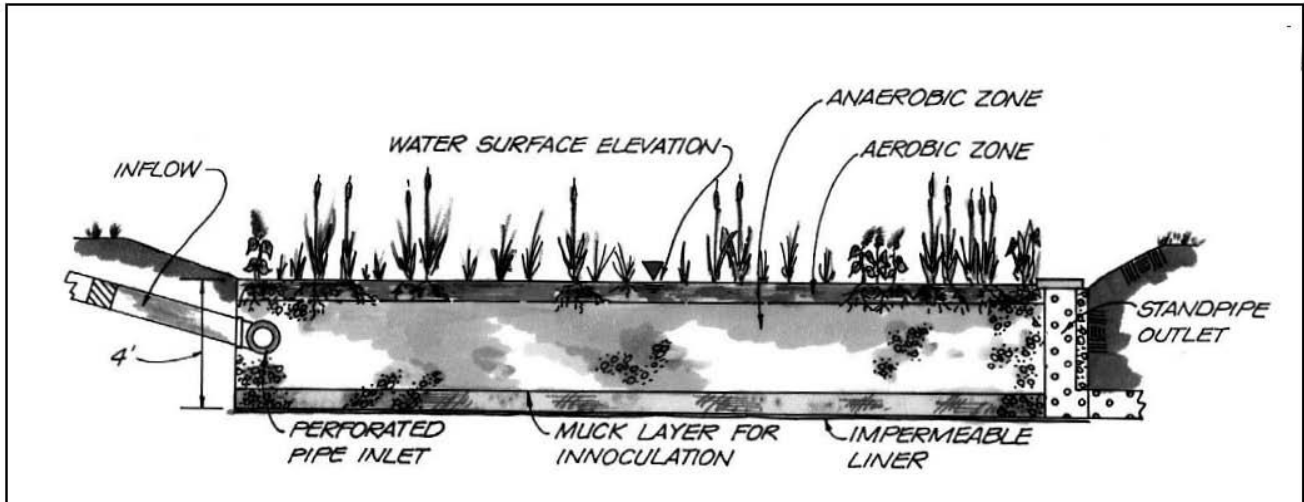

Figure 28.7 Schematics of Submerged Gravel Wetland System
 (Sources: Center for Watershed Protection; Roux Associates Inc.)

28.9 Design Forms

Design Procedure Form: Storm Water Wetlands

PRELIMINARY HYDROLOGIC CALCULATIONS

- 1a. Compute WQ_v volume requirements
 Compute Runoff Coefficient, R_v
 Compute WQ_v
- 1b. Compute SP_v
 Compute average release rate
 Compute Q_p (100-year detention volume required)
 Add 15% to the required Q_p volume (if ED)
 Compute (as necessary) Q_t

$R_v =$ _____
 $WQ_v =$ _____ acre-ft

$SP_v =$ _____ acre-ft
 release rate = _____ cfs
 $Q_p =$ _____ acre-ft
 $Q_p * 15\% =$ _____ acre-ft
 $Q_t =$ _____ cfs

STORM WATER WETLAND DESIGN

- 2. Is the use of a storm water wetland appropriate?
- 3. Confirm local design criteria and applicability.
- 4. Pretreatment volume
 $Vol_{pre} = 1 (0.1'')(1'/12'')$
- 5. Allocation of Pool, Marsh, and ED Volumes
 Shallow Wetland: $Vol_{pool} = 0.25 (WQ_v)$
 $Vol_{marsh} = 0.75 (WQ_v)$
 Shallow ED Wetland: $Vol_{pool} = 0.25 (WQ_v)$
 $Vol_{marsh} = 0.25 (WQ_v)$
 $Vol_{ED} = 0.5 (WQ_v)$
 Pocket Wetland: $Vol_{pool} = 0.25 (WQ_v)$
 $Vol_{marsh} = 0.75 (WQ_v)$
- 6. Allocation of Surface Area
 (choose from Table 5.2.27-1 based on wetland variant)
 Pool/Deepwater Wetland Zone (1.5-6 feet deep)
 Low Marsh Wetland Zone (6-18 inches deep)
 High Marsh Wetland Zone (0-6 inches deep)
 Semi-Wet Wetland Zone (above pool depth)

See subsections 5.2.27.4 and 5.2.27.5-A

$Vol_{pre} =$ _____ acre-ft

$Vol_{pool} =$ _____ acre-ft
 $Vol_{marsh} =$ _____ acre-ft

$Vol_{pool} =$ _____ acre-ft
 $Vol_{marsh} =$ _____ acre-ft
 $Vol_{ED} =$ _____ acre-ft

$Vol_{pool} =$ _____ acre-ft
 $Vol_{marsh} =$ _____ acre-ft

$Area_{water} =$ _____ acres, % = _____
 $Area_{low} =$ _____ acres, % = _____
 $Area_{high} =$ _____ acres, % = _____
 $Area_{semi} =$ _____ acres, % = _____

Conduct grading and determine storage available for marsh zones (and ED if applicable), and compute orifice size

Prepare an elevation-storage table and curve using the average area method for computing volumes.

Elevation	Area	Average Area	Depth	Volume	Cummulative Volume	Cummulative Volume	Volume above Permanent Pool
MSL	ft ²	ft ²	ft	ft ³	ft ³	ac-ft	ac-ft

Notes: _____

7. WQ_v Orifice Computations
 Average ED release rate (if applicable)
 Average head, $h = (ED \text{ elev.} - \text{Permanent pool elev.})/2$
 Area of orifice from orifice equation
 $Q = CA(2gh)^{0.5}$
- Discharge equation $Q = (h)^{0.5}$
- Compute release rate for SP_v -ED control and establish SP_v elevation
 Release rate =
 Average head, $h = (SP_v \text{ elev.} - \text{Permanent pool elev.})/2$
 Area of orifice from orifice equation
 $Q = CA(2gh)^{0.5}$
 Discharge equation $Q = (h)^{0.5}$
8. Calculate Q_p release rate and WSEL

release rate _____ cfs
 $h =$ _____ ft

$A =$ _____ ft^2
 diameter = _____ in
 factor = _____ $(h)^{0.5}$

WSEL = _____ ft-NGVD
 release rate = _____ cfs
 $h =$ _____ ft
 $A =$ _____ ft^2
 diameter = _____ in
 factor = _____ $(h)^{0.5}$

Set up a stage-storage-discharge relationship

Elevation	Storage	Low Flow WQ_v -ED	Riser			Barrier		Emergency		Total Storage
			SP_v -ED	High Storage		Inlet	Pipe	Spillway		
MSL	ac-ft	Ft(ft) Q(cfs)	Ft(ft) Q(cfs)	Orif. Ft Q	Weir Ft Q	Ft(ft) Q(cfs)	Ft(ft) Q(cfs)	Ft(ft) Q(cfs)	Q(cfs)	

Q_p = pre-dev. peak discharge - (WQ_v -ED release + SP_v -ED release)
 Maximum head =
 Use weir equation for slot length ($Q = CLH^{3/2}$)

Check inlet condition
 Check outlet condition

$Q_p =$ _____ cfs
 $H =$ _____ ft
 $L =$ _____ ft

**Use culvert charts
 (Section 4.2)**

9. Size emergency spillway, calculate 100-year WSEL and set top of embankment elevation
10. Investigate potential pond hazard classification
11. Design inlets, sediment forebays, outlet structures, maintenance access, and safety features.
12. Attach landscaping plan (including wetland vegetatoin)

$WSEL_{25} =$ _____ ft
 $WSEL_{100} =$ _____ ft
 $Q_{ES} =$ _____ cfs
 $Q_{ps} =$ _____ cfs

See Appendix H

See subsection 5.2.27.5-D through H

See Appendix F

Notes:

29.0 Stormwater Control Design Examples

29.1 Introduction

The five stormwater control examples included in this section are presented to provide example computations using the most commonly used design standards. All of the possible options that might be incorporated into a stormwater control structure are not covered in these examples.

For all possible design standards and options that might be incorporated into the design of a stormwater control structure, refer to *Table 1.1 of the Planning Technical Manual*. In order to apply design standards to a given stormwater control structure, additions or modifications to *Section 1.0 and 2.0 of the Planning Technical Manual* must also be considered. These are found in the Criteria Manual.

The Criteria Manual may determine the extent of downstream assessments; the return periods to be used for the “Streambank Protection” and “Conveyance” storms; and the acceptable design focus area to be used for Water Quality Protection, Streambank Protection, and Flood Control. It is evident that there are many combinations of design options that might apply to a given stormwater control structure.

29.2 Stormwater Pond Design Example

The following design example is for a wet extended detention (ED) stormwater pond. The design options chosen for this example are Option 1 for Water Quality Protection (WQ_v), Option 4 for Streambank Protection (SP_v), and Option 4 for Flood Control (Q_{p100}). The layout of the Rolling Meadows Subdivision is shown in Figure 29.1.

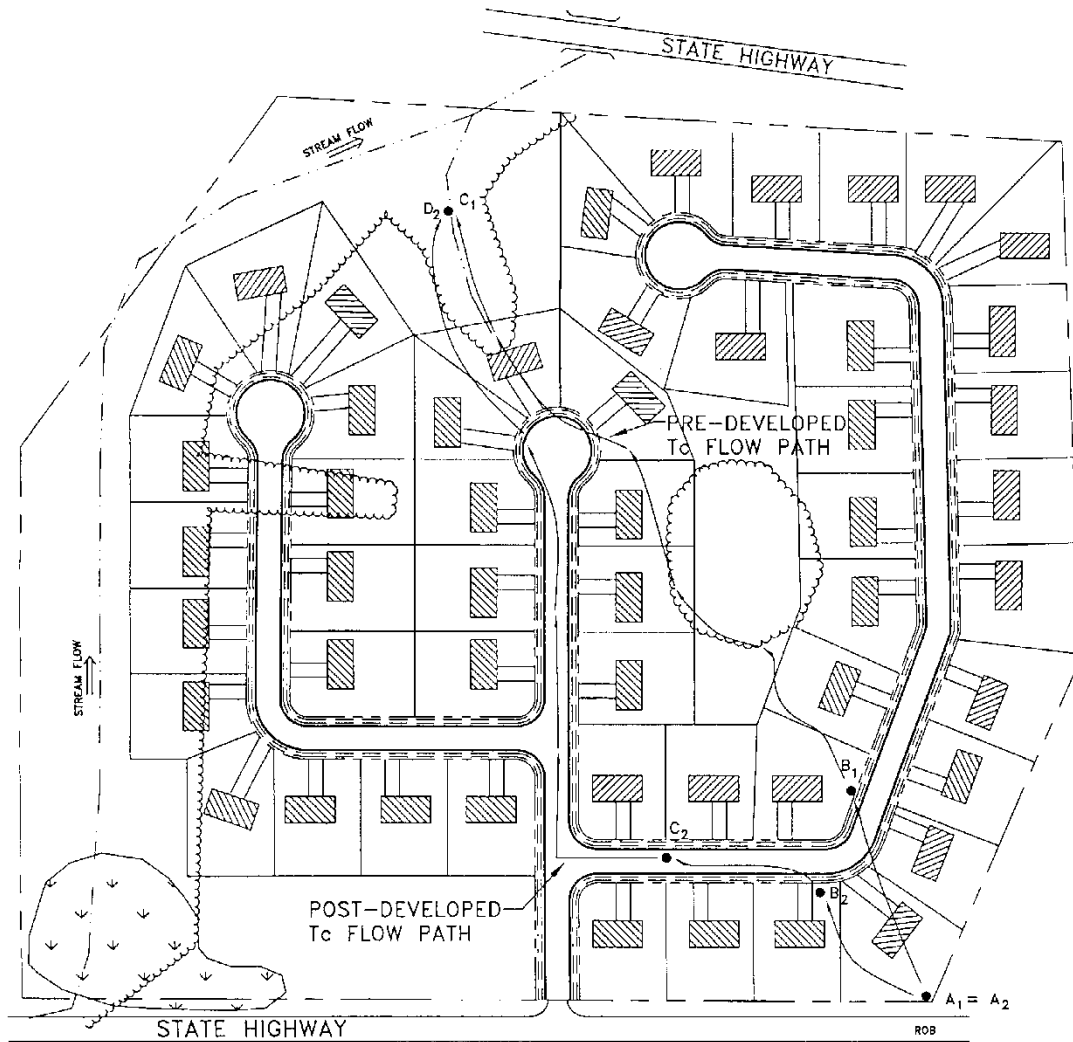

Figure 29.1 Rolling Meadows Site Plan

<u>Base Data</u>	<u>Hydrologic Data</u>	
Site Area = Total Drainage Area (A) = 38.0 ac	<u>Pre</u>	<u>Post</u>
Measured Impervious Area=13.8 ac; or I=13.8/38=36.3%	CN	76
Soils Types: 20% "C", 80% "B"	t_c	0.33 hr
Zoning: Residential (½ acre lots)		85
Denton County		0.19 hr

Computation of Preliminary Stormwater Storage Volumes and Peak Discharges

Step 1: Compute runoff control volumes from the integrated Design Focus Areas

More details hydrologic calculations will be required during the design step – these numbers are preliminary.

Compute Water Quality Volume, WQ_v

- Compute Runoff Coefficient, R_v

$$\begin{aligned} R_v &= 0.05 + (I) (0.009) \\ &= 0.05 + (36.3) (0.009) = 0.38 \end{aligned}$$

- Compute WQ_v

$$\begin{aligned} WQ_v &= (1.5") (R_v) (A) \\ &= (1.5") (0.38) (38.0 \text{ ac}) (1\text{ft}/12\text{in}) \\ &= \underline{1.44 \text{ ac-ft}} \end{aligned}$$

Develop Site Hydrologic and Hydrologic Input Parameters

Per Figures 29.2 and 29.3. Note that any hydrologic models using SCS procedures, such as TR-20, HEC-HMS, or HEC-1, can be used to perform preliminary hydrologic calculations

Condition	Area	CN	Tc
	Ac		hrs
pre-developed	38	76	0.33
post-developed	38	85	0.19

Perform Preliminary Hydrologic Calculations

Condition	$Q_{1\text{-yr}}$	$Q_{1\text{-yr}}$	$Q_{100\text{-yr}}$
Runoff	<i>Inches</i>	<i>cfs</i>	<i>cfs</i>
pre-developed	0.78	26.9	266
post-developed	1.29	61.3	402

Compute Streambank Protection Volume, (SP_v)

For stream streambank protection, provide 24 hours of extended detention for the 1-year event.

Utilize SCS approach to Compute Streambank Protection Storage Volume

See [Section 1.1 of the Hydrology Technical Manual](#).

- Initial abstraction (I_a) for CN of 85 is 0.353: [$I_a = (200/CN - 2)$]
- $I_a/P = (0.353)/ 2.64 \text{ inches} = 0.13$
- $T_c = 0.19 \text{ hours}$
- $q_u = 800 \text{ csm/in}$ (Type II Storm)

Knowing q_u and T (extended detention time), find q_o/q_i . For a Type II rainfall distribution.

- Peak outflow discharge/peak inflow discharge (q_o/q_i) = 0.022
- $V_s/V_r = 0.683 - 1.43(q_o/q_i) + 1.64(q_o/q_i)^2 - 0.804(q_o/q_i)^3$
- Where V_s equals streambank protection storage (SP_v) and V_r equals the volume of runoff in inches.
- $V_s/V_r = 0.65$

- Therefore, $V_s = SP_v = 0.65(1.29'')(1/12)(38 \text{ ac}) = 2.66 \text{ ac-ft}$ (116,077 cubic feet)

Define the average SP_v -ED Release Rate

- The above volume, 2.66 ac-ft, is to be released over 24 hours.
- $(2.66 \text{ ac-ft} \times 43,560 \text{ ft}^2/\text{ac}) / (24 \text{ hrs} \times 3,600 \text{ sec/hr}) = 1.34 \text{ cfs}$

Analyze Safe Passage of 100 Year Design Storm (Q_f)

At final design, provide safe passage for the 100-year event, or detain it, depending on downstream conditions and local policy. Based on field observation and review of local requirements no control of the 100-year storm is necessary. If it were storage estimates would have been made similar to the Q_p Volume in the previous sub-step.

Symbol	Control Volume	Volume Required (ac- ft)	Notes
WQ_v	Water Quality	1.44	
SP_v	Streambank Protection	2.66	Average extended detention release rate is 1.34 cfs over 24 hours
Q_f	Extreme Flood Protection	4.88	Detain to pre-developed conditions; Provide safe passage for the 100-year event in final design

The Modified Rational Method is used to estimate the storage volume.

Determine the Allowable Release Rate, Q_a

- Predevelopment Rational Coefficient, $c_a = 0.45$
- For $t_c = 0.33 \text{ hr}$, from *Table 5.3 of the Hydrology Technical Manual*, $i_{100} = 6.99 \text{ in/hr}$
- From *Equation 1.26 of the Hydrology Technical Manual*, $Q_a = c_a i A = (0.45) (6.99) (38) = 119.5 \text{ cfs}$

Determine the Critical Duration of the Storm T_d

- From *Table 1.18 of the Hydrology Technical Manual*, $a = 325.18$; $b = 24.822$
- Post-developed Rational Coefficient, $c = 0.61$
- From *Equation 1.27 of the Hydrology Technical Manual*,
 $T_d = \sqrt{(2cAab/Q_a)} - b$
 $T_d = \sqrt{(2(0.61)(38) (325.18) (24.822))/(119.5)} - (24.822) = 31.1 \text{ min}$
- From *Table 5.3 of the Hydrology Technical Manual*, for $T_d = 31.1 \text{ min}$, $i_{T_d} = 5.55 \text{ in/hr}$
 $P_{T_d} = 5.55 \text{ in/hr} (31.1 \text{ min}) (\text{hr} / 60 \text{ min}) = 2.88 \text{ in}$

Determine the Allowable Release Rate, Q_a

- Predevelopment Rational Coefficient, $c_a = 0.45$
- For $t_c = 0.33 \text{ hr}$, from *Table 5.3 of the Hydrology Technical Manual*, $i_{100} = 6.99 \text{ in/hr}$
- From *Equation 1.26 of the Hydrology Technical Manual*,
 $Q_a = c_a i A = (0.45) (6.99) (38) = 119.5 \text{ cfs}$

Compute Storage Volume

- Post-developed Time of concentration, $t_c = 0.19 \text{ hr} (60 \text{ min/hr}) = 11.4 \text{ min}$
- From *Equation 1.28a of the Hydrology Technical Manual*,

$$V_{pre} = 60 [cAa - (2cabAQ_a)^{1/2} + (Q_a/2)(b - t_c)]$$

$$V_{pre} = 60 \{ [0.61(38)(325.18) - 2(0.61)(24.822)(38)(119.5)]^{1/2} + (119.5/2)(24.822 - 11.4) \}$$

$$= 99154 \text{ ft}^3$$

- From *Equation 1.28b of the Hydrology Technical Manual*,

$$V_{max} = V_{pre} * P_{180}/P_{Td}$$

$$P_{180} = 1.79 \text{ in/hr (3 hr) in Table 5.3 of the Hydrology Technical Manual.}$$

$$V_{max} = 99154 (5.37/2.88) = 184881 \text{ ft}^3 = 4.24 \text{ ac-ft}$$

Experience has shown that additional 10-15% storage is required when multiple levels of extended detention are provided. So, for preliminary sizing purposes added 15% to the required volume for downstream flood control. $O_f = 1.15 (4.24) = 4.88 \text{ ac-ft}$

PEAK DISCHARGE SUMMARY				
JOB:	P'TREE MEADOWS			EWB
DRAINAGE AREA NAME:	PRE-DEVELOPED CONDITIONS			3-Jan-00
COVER DESCRIPTION	SOIL GROUP A, B, C, D?	C from TABLE 1.6 Hydrology Section	CN from TABLE 1.9 Hydrology Section	AREA (in acres)
meadow (good cond.)	D	0.5	78	30.40
meadow (good cond.)	C	0.5	71	2.60
woods (good cond.)	C	0.15	70	5.00
AREA SUBTOTALS:				38.00
Time of Concentration	Surface Cover	Manning 'n'	Flow Length	Slope
2-Yr 24 Hr Rainfall = 3.36"	Cross Section	Wetted Per	Avg Velocity	Tt (hrs)
Sheet Flow	dense grass	'n'= 0.24	150ft	2.50%
				0.29 hrs
Shallow Flow	unpaved		500 ft	4.00%
			3.23 fps	0.04 hrs
Channel Flow				
Total Area in Acres =	38.00	Total Sheet Flow =	Total Shallow Flow =	Total Channel Flow =
Weighted CN =	76			
Time of Concentration =	0.33 hrs	0.29 hrs.	0.04 hrs.	0.00 hrs.
Pond Factor =	1	RAINFALL TYPE II		
STORM	Precipitation (P) inches	Runoff (Q)	Qp, PEAK DISCHARGE (cfs)	
1 Year	2.64	0.78	26.9	
2 Year	3.36	1.26	45.1	
5 Year	4.8	2.37	88	
10 Year	5.52	2.97	113	
25 Year	6.96	4.22	165	
50 Year	7.92	5.09	205	
100 Year	9.36	6.41	266	

Figure 29.2 Rolling Meadows Pre-Development Conditions

PEAK DISCHARGE SUMMARY				
JOB:	P'TREE MEADOWS			EWB
DRAINAGE AREA NAME:	POST-DEVELOPED CONDITIONS			3-Jan-00
COVER DESCRIPTION	SOIL GROUP A, B, C, D?	C from TABLE 1.6 Hydrology Section	CN from TABLE 1.9 Hydrology Section	AREA (in acres)
open space (good cond.)	D	0.5	80	20.00
woods (good cond.)	C	0.15	70	5.0
impervious area	D	.95	98	10.4
Impervious area	C	.95	98	2.6
AREA SUBTOTALS:				38.00
Time of Concentration	Surface Cover	Manning 'n'	Flow Length	Slope
2-Yr 24 Hr Rainfall = 3.36"	Cross Section	Wetted Per	Avg Velocity	Tt (hrs)
Sheet Flow	short grass	'n' = 0.15	100 ft	2.50%
				0.15 hrs
Shallow Flow	paved		300 ft	2.00%
			2.87 fps	0.03 hrs
Channel Flow		'n' = 0.013	600 ft	2.00%
Hydraulic Radius	X-S estimated	WP estimated	16.21 fps	0.01 hrs
Total Area in Acres =	38.00	Total Sheet	Total Shallow	Total Channel
Weighted CN =	85	Flow =	Flow =	Flow =
Time of Concentration =	0.19 hrs	0.15 hrs.	0.03 hrs.	0.01 hrs.
Pond Factor =	1	RAINFALL TYPE II		
STORM	Precipitation (P) inches	Runoff (Q)	Qp, PEAK DISCHARGE (cfs)	
1 Year	2.64	1.29	61.3	
2 Year	3.36	1.89	92.3	
5 Year	4.8	3.18	159	
10 Year	5.52	3.85	196	
25 Year	6.96	5.21	269	
50 Year	7.92	6.14	322	
100 Year	9.36	7.53	402	

Figure 29.3 Rolling Meadows Post-Development Conditions

Step 2: Determine if the development site and conditions are appropriate for the use of a stormwater pondSite Specific Data:

The site area and drainage area to the pond is 38.0 acres. Existing ground at the pond outlet is 919 MSL. Soil boring observations reveal that the seasonally high water table is at elevation 918. The underlying soils are predominantly clay and are suitable for earthen embankments and to support a wet pond without a liner. The stream invert at the adjacent stream is at elevation 916.

Other site screening aspects listed in *Section 1.1 and 1.2 of the Hydraulics Technical Manual* were assessed and a pond was found to be suitable.

Step 3: Confirm local design criteria and applicability

There are no additional requirements for this site.

Step 4: Determine pretreatment volume

Size wet forebay to treat 0.1"/impervious acre. (13.8 ac) (0.1") (1/12") = **0.12 ac-ft**
(forebay volume is included in WQ_v as part of permanent pool volume)

Step 5: Determine permanent pool volume (and water quality extended detention volume)

Size permanent pool volume to contain 50% of WQ_v :

$0.5 \times (1.44 \text{ ac-ft}) = \mathbf{0.72 \text{ ac-ft}}$. (includes 0.12 ac-ft of forebay volume)

Size extended detention volume to contain 50% of WQ_v : $0.5 \times (1.44 \text{ ac-ft}) = \mathbf{0.72 \text{ ac-ft}}$

Note: This design focus area assumes that all of the extended detention volume will be in the pond at once. While this will not be the case, since there is a discharge during the early stages of storms, this conservative approach allows for extended detention control over a wider range of storms, not just the target rainfall.

Step 6: Determine pond location and preliminary geometry. Conduct pond grading and determine storage available for permanent pool and water quality extended detention

This step involves initially grading the pond (establishing contours) and determining the elevation-storage relationship for the pond. Storage must be provided for the permanent pool (including sediment forebays), extended detention (WQ_v -ED), SP_v -ED, downstream flood protection, plus sufficient additional storage to pass the 100-year storm with minimum freeboard. An elevation-storage table and curve is prepared using the average area method for computing volumes. See Figure 29.4 for pond location on site, Figure 29.5 grading and Figure 29.6 for Elevation-Storage Data.

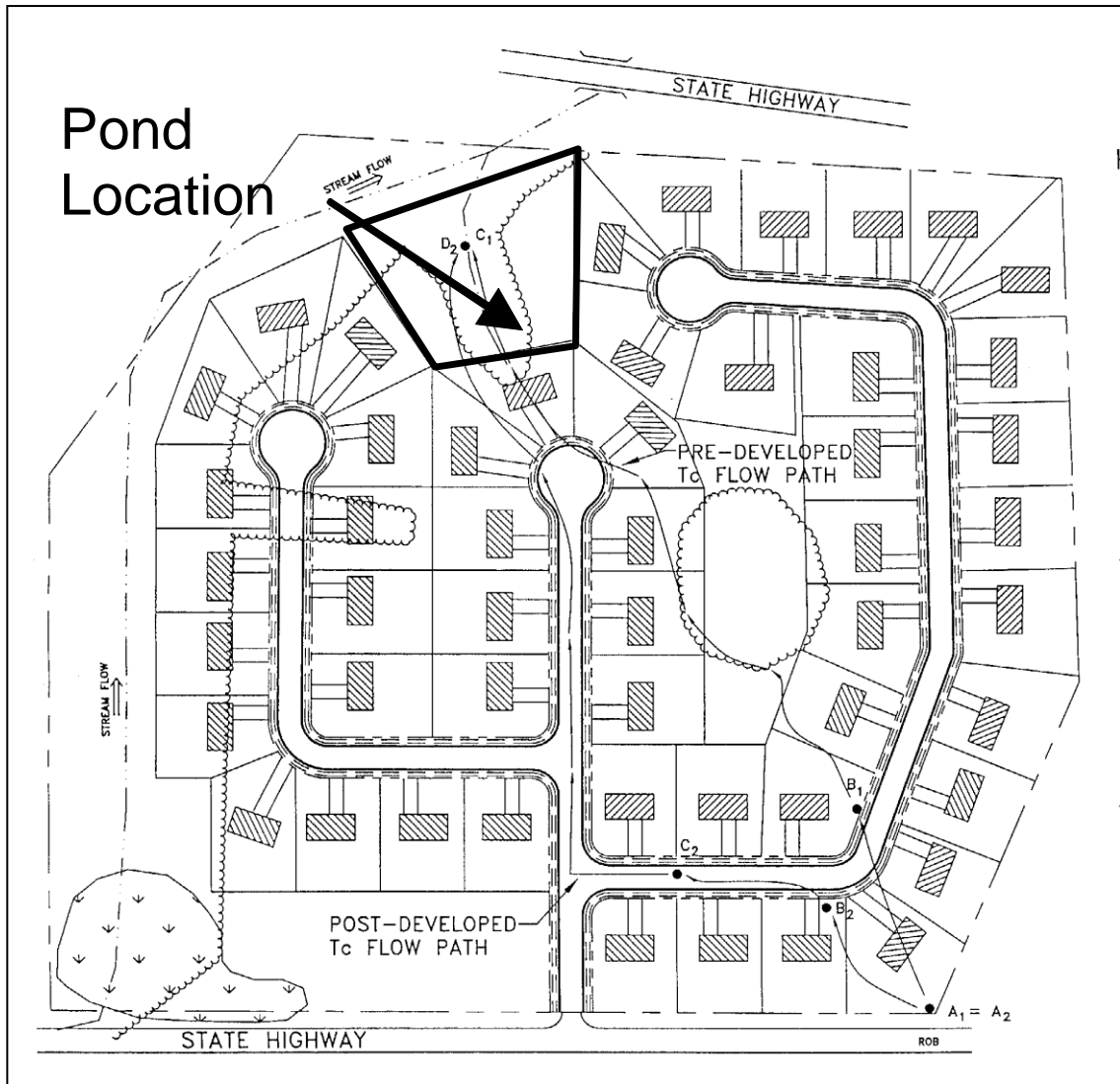

Figure 29.4 Pond Location on Site

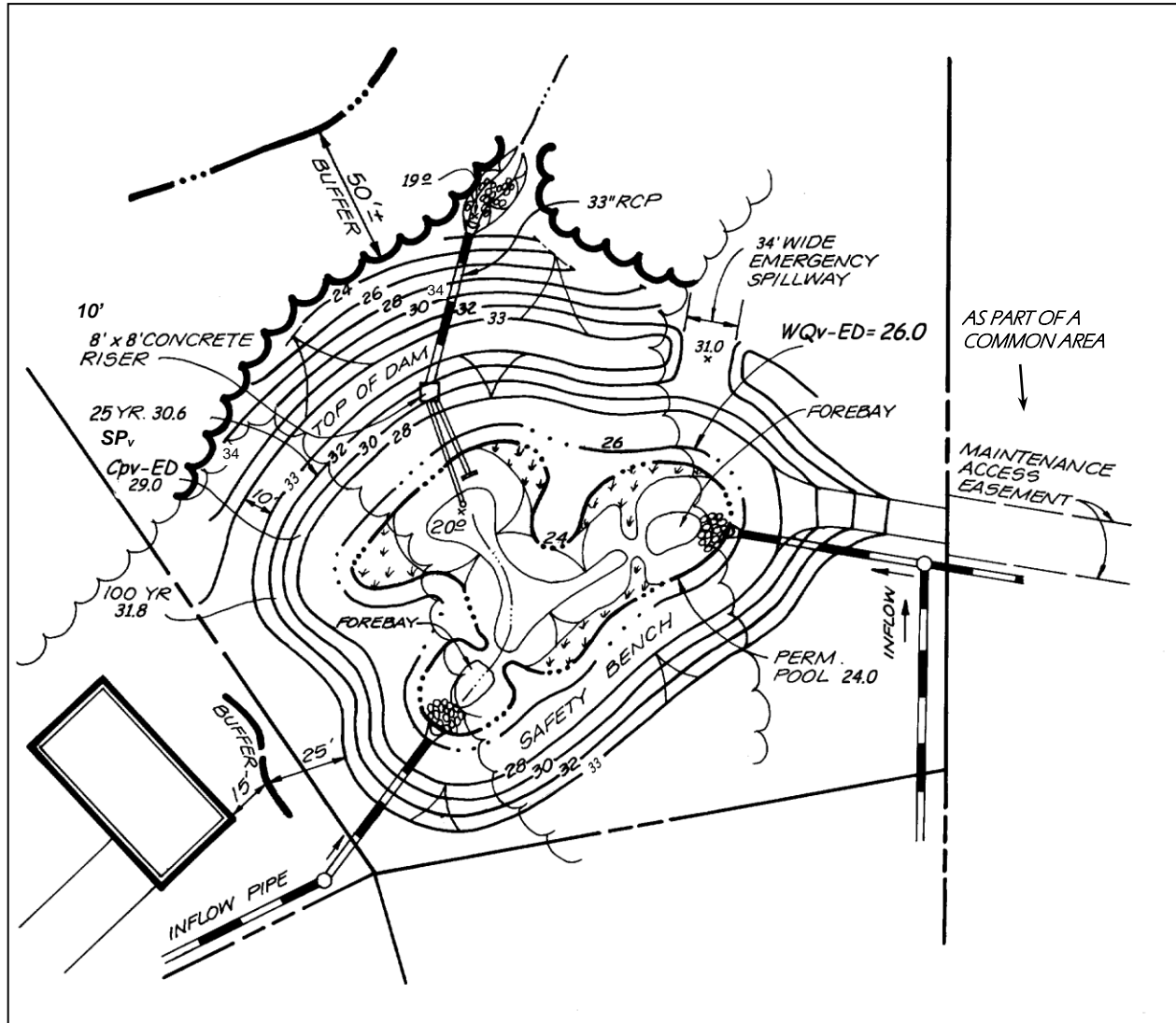

Figure 29.5 Plan View of Pond Grading (Not to Scale)

Elevation MSL	Average Area ft^2	Depth ft	Volume ft^3	Cumulative Volume ft^3	Cumulative Volume ac-ft	Volume Above Permanent Pool ac-ft
920.0						
921.0	7838	1	7838	7838	0.18	
923.0	11450	2	22900	30738	0.71	
924.0	14538	1	14538	45275	1.04	0
925.0	15075	1	15075	60350	1.39	0.35
925.5	16655	0.5	8328	68678	1.58	0.54
926.0	17118	0.5	8559	77236	1.77	0.73
926.5	21000	0.5	10500	87736	2.01	0.97
927.0	25000	0.5	12500	100236	2.30	1.26
927.5	30000	0.5	15000	115236	2.65	1.61
928.0	36000	0.5	18000	133236	3.06	2.02
928.5	38000	0.5	19000	152236	3.49	2.46
929.0	41000	0.5	20500	172736	3.97	2.93
929.5	43000	0.5	21500	194236	4.46	3.42
930.0	45000	0.5	22500	216736	4.98	3.94
930.5	47000	0.5	23500	240236	5.52	4.48
931.0	49000	0.5	24500	264736	6.08	5.04
931.5	52000	0.5	26000	290736	6.67	5.64
932.0	55000	0.5	27500	318236	7.31	6.27
932.5	58000	0.5	29000	347236	7.97	6.93
933.0	61000	0.5	30500	377736	8.67	7.63
933.5	65000	0.5	32500	410236	9.42	8.38
934.0	69000	0.5	34500	444736	10.21	9.17
935.0	74000	1	74000	518736	11.91	10.87

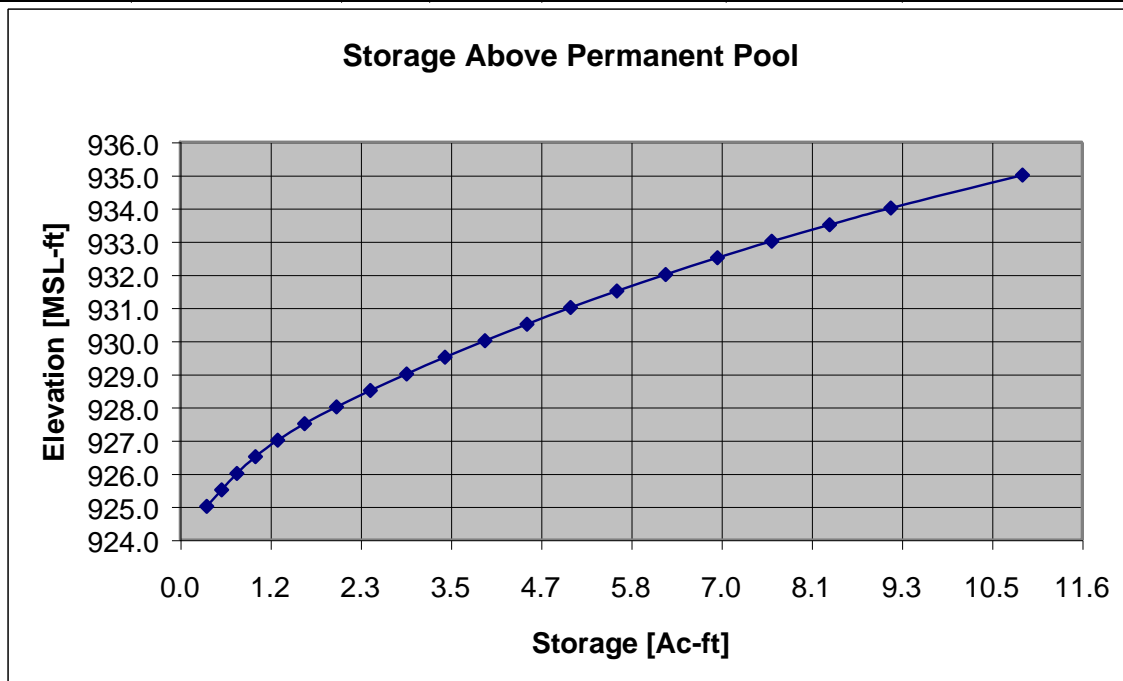

Figure 29.6 Storage-Elevation Table and Curve

Set basic elevations for pond structures

- The pond bottom is set at elevation 920.0.
- Provide gravity flow to allow for pond drain, set riser invert at 919.5.
- Set barrel outlet elevation at 919.0.

Set water surface and other elevations

- Required permanent pool volume = 50% of $WQ_v = 0.72$ ac-ft. From the elevation-storage table, read elevation 924.0 (1.04 ac-ft > 0.72 ac-ft). The site can accommodate it and it allows a small safety factor for fine sediment accumulation - OK
- Forebay volume provided in two pools with avg. vol. = 0.08 ac-ft each (0.16 ac-ft > 0.12 ac-ft) OK
- Required extended detention volume (WQ_v -ED) = 0.72 ac-ft. From the elevation-storage table (volume above permanent pool), read elevation 926.0 (0.73 ac-ft > 0.72 ac-ft) OK. Set extended detention wsel = 926.0

Note: Total storage at elevation 926.0 = 1.77 ac-ft (greater than required WQ_v of 1.44 ac-ft)

Compute the required WQ_v -ED orifice diameter to release 0.72 ac-ft over 24 hours

- Avg. extended detention release rate = $(0.72 \text{ ac-ft})(43,560 \text{ ft}^2/\text{ac}) / (24 \text{ hr})(3600 \text{ sec/hr}) = 0.36 \text{ cfs}$
- Average head = $(926.0 - 924.0) / 2 = 1.0'$
- Use orifice equation to compute cross-sectional area and diameter
 - $Q = CA(2gh)^{0.5}$, for $Q = 0.36 \text{ cfs}$, $h = 1.0 \text{ ft}$, $C = 0.6$ = discharge coefficient) solve for A
 - $A = 0.36 \text{ cfs} / [(0.6)((2)(32.2 \text{ ft/s}^2)(1.0 \text{ ft})^{0.5})]$ $A = 0.075 \text{ ft}^2$, $A = \pi d^2 / 4$; dia. = 0.31 ft = 3.7"
 - Use 4" pipe with 4" gate valve to achieve equivalent diameter

Compute the stage-discharge equation for the 3.7" dia. WQ_v orifice

- $Q_{WQ_v\text{-ED}} = CA(2gh)^{0.5} = (0.6)(0.075 \text{ ft}^2) [((2)(32.2 \text{ ft/s}^2))^{0.5}] (h^{0.5})$,
- $Q_{WQ_v\text{-ED}} = (0.36) h^{0.5}$, where: $h = \text{wsel} - 924.16$

(Note: account for one half of orifice diameter when calculating head)

Step 7: Compute extended detention orifice release rate(s) and size(s), and establish SP_v elevationSet the SP_v pool elevation

- Required SP_v storage = 2.66 ac-ft (see Table 29.1).
- From the elevation-storage table, read elevation 929 (this includes the WQ_v).
- Set SP_v wsel = 929

Size SP_v orifice

- Size to release average of 1.34 cfs.
 - Average WQ_v -ED orifice release rate is 0.66 cfs, based on average head of 3.34' $(926 - 924.16 + (929 - 926)/2)$
 - SP_v -ED orifice release = $1.34 - 0.66 = 0.66 \text{ cfs}$
- Head = $(929 - 926.0) / 2 = 1.5'$

Use orifice equation to compute cross-sectional area and diameter

- $Q = CA(2gh)^{0.5}$, for $h = 1.5'$
 - $A = 0.68 \text{ cfs} / [(0.6)((2)(32.2'/s^2)(1.5'))^{0.5}]$
 - $A = 0.12 \text{ ft}^2$, $A = \pi d^2 / 4$;
 - $\text{dia.} = 0.38 \text{ ft} = 4.6''$
 - Use PVC pipe to the nearest 1" (in this case 5" PVC pipe)

Compute the stage-discharge equation for the 4.6" dia. SP_v-orifice

- $Q_{\text{SPv-ED}} = CA(2gh)^{0.5} = (0.6)(0.12 \text{ ft}^2) [((2)(32.2'/s^2))^{0.5}] (h^{0.5})$,
- $Q_{\text{SPv-ED}} = (0.55)(h^{0.5})$, where: $h = \text{wsel} - 926.19$

(Note: Use the distance from the water surface to the center of the orifice when calculating head)

Step 8: Calculate Q_f (100-year storm) release rate and water surface elevation

In order to calculate the release rate and water surface elevation, the designer must set up a stage-storage-discharge relationship for the control structure for each of the low flow release pipes (WQ_v-ED and SP_v-ED) plus the 100 year storm.

Develop basic data and information

- The 100 year pre-developed peak discharge = 266 cfs,
- The post developed inflow = 402 cfs, from Table 29.1,
- From previous estimate Q_f = 4.88 ac-ft.
- From elevation-storage table (Figure 29.6), read elevation 930.9.

Size 100-year slot to release 266 cfs at elevation 930.9.

- @ wsel 930.9:
 - WQ_v-ED orifice releases 0.93 cfs,
 - SP_v-ED orifice releases 1.19 cfs, therefore;
 - Allowable Q_p = 266 cfs - (.93 + 1.19) = 263.9 cfs, say 264 cfs.
- Max head = (930.9 – 929) = 1.9'
- Use weir equation to compute slot length
 - $Q = CLH^{3/2}$
 - $L = 264 \text{ cfs} / (3.1)(1.9^{3/2}) = 32.5 \text{ ft}$
- Use four 8.5 ft x 2 ft slots for 100-year release (opening should be slightly larger than needed so as to have the barrel control before slot goes from weir flow to orifice flow).

Check orifice equation using cross-sectional area of opening

- $Q = CA(2gh)^{0.5}$, for $h = 1.0'$ (For orifice equation, h is from midpoint of slot)
- $A = 4(8.5')(2') = 68.0 \text{ ft}^2$
- $Q = 0.6(68.0\text{ft}^2) [(64.4)(1.0)]^{0.5} = 327 \text{ cfs} > 266 \text{ cfs}$, so use weir equation

$$Q_{100} = (3.1)(34')H^{3/2}, \quad Q_{100} = (105.8)H^{3/2}, \quad \text{where } H = \text{wsel} - 929.0$$

Size barrel to release approximately 266 cfs at elevation 930.9

- Check inlet condition: (use *Section 3.3 of the Hydraulic Technical Manual*)
 - $H_w = 930.9 - 919.5 = 11.4$ ft
 - Try 60" diameter RCP, Using *Figure 1.19a of the Hydraulics Technical Manual* with entrance condition 1
 - $H_w / D = 11.4/5 = 2.28$, Discharge = 280 cfs
- Check outlet condition:

$$Q = a [(2gH)/(1+k_m+k_pL)]^{0.5}$$

where:

Q = discharge in cfs

a = pipe cross sectional area in ft²

g = acceleration of gravity in ft/sec²

H = head differential (wse1 - downstream centerline of pipe or tailwater elev.)

k_m = coefficient of minor losses (use 1.0)

k_p = pipe friction loss coef. ($= 5087n^2/d^{4/3}$, d in ", n is Manning's n)

L = pipe length in ft

- $H = 930.9 - (919.0 + 2.5) = 9.4'$
- for 60" RCP, 70 feet long:
- $Q = 19.63 [(64.4) (9.4) / 1+1+(.003) (70)]^{0.5} = 324.9$ cfs
- 280 cfs < 325 cfs, so barrel is inlet controlled.

Note: Pipe will control flow before high stage inlet reaches max head.

Complete stage-storage-discharge summary (Figure 29.7) up to preliminary 100-year wse1 (930.9) and route 100 year post-developed condition inflow using computer software.

Elevation MSL	Storage ac-ft	Flow Flow WQv-ED 3.7" eq dia		Riser						Barrel				Emergency Spillway		Total Discharge	
				SPv-ED 4.7" eq dia		High Stage Slot				Inlet		Pipe					
						Orifice		Weir									
H ft	Q cfs	H ft	Q cfs	H ft	Q cfs	H ft	Q cfs	H ft	Q cfs	H ft	Q cfs	H ft	Q cfs	H ft	Q cfs	Q cfs	
924.0	0.00	0	0														0
925.0	0.35	0.8	0.33														0.33
925.5	0.54	1.3	0.42														0.42
926.0	0.73	1.8	0.49	0	0												0.49
926.5	0.97	2.3	0.55	0.3	0.31												0.86
927.0	1.26	2.8	0.61	0.8	0.50												1.11
927.5	1.61	3.3	0.66	1.3	0.63												1.29
928.0	2.02	3.8	0.71	1.8	0.74												1.45
928.5	2.46	4.3	0.75	2.3	0.84												1.59
929.0	2.93	4.8	0.79	2.8	0.92	N/A		0.0	0.0								1.71
929.5	3.42	5.3	0.83	3.3	1.00			0.5	37.4								39.2
930.0	3.94	5.8	0.87	3.8	1.07			1.0	105.8								107.7
930.5	4.48	6.3	0.91	4.3	1.14			1.5	194.4								196.5
930.9	4.93	6.7	0.93	4.7	1.19			1.9	277.1	11.4	280.0	9.4	324.9				279.2
931.0	5.04	-	-	-	-	1.0	327.0	2.0	299.2	11.5	280.0	9.5	326.6	0.0	0.0		280.0
931.5	5.64	-	-	-	-					12.0	285.0	10.0	335.1	0.5	24.0		309.0
932.0	6.27	-	-	-	-					13.0	290.0	10.5	343.4	1.0	79.0		369.0
932.5	6.93	-	-	-	-					13.5	300.0	11.0	351.4	1.5	154.0		454.0

Figure 29.7 Stage-Storage-Discharge Summary

Note: Adequate outfall protection must be provided in the form of a riprap channel, plunge pool, or combination to ensure non-erosive velocities. Plans must indicate pipe class, joint type, and bedding.

Step 9: Design embankment(s) and spillway(s)

Set the emergency spillway at elevation 931.0 and use design information and criteria Earth Spillways (not included in this manual)

- Q_{100} inflow = 402 cfs.
- Try 34' wide vegetated emergency spillway with 3:1 side slopes.
 - @ elevation 932.6, $H = 1.5'$, Emergency spillway, $Q_{ES} = 154$ cfs. Primary spillway, $Q_{PS} = 300$ cfs
 - $Q_{ES} + Q_{PS} = 454$ cfs, will be able to safely convey $Q_f = 402$. (use computer routing for exact elevations and discharges).
 - 100 year wsel = 932.2, say 932.5, so set top of embankment with 1 foot of freeboard at elevation 933.5.

Step 10: Investigate potential pond hazard classification

Refer to Texas Commission on Environmental Quality (TCEQ) Dam Safety Program to establish preliminary classification of embankment and whether special design criteria need to be met. Their regulations apply for the construction of dams that are six feet or more in height.

Check pond classification: Height = 931 - 919 = 12', equals assumed embankment height, Pond will remain Category II or lower.

As reported in Table 29.1, the preliminary maximum storage volume required is about 4.24 acre-feet. Therefore, for initial design considerations, no additional dam safety requirements will apply. Once final design elevations and storage volumes have been determined, a final check for dam rules exemption should be made by the designer.

Step 11: Design inlets, sediment forebay(s), outlet structures, maintenance access, and safety features.

Control Element	Type/Size of Control	Storage Provided	Elevation	Discharge	Remarks
<i>Units</i>		<i>Acre-feet</i>	<i>MSL</i>	<i>cfs</i>	
Permanent Pool		0.86	924.0	0	part of WQ_v
Forebay	submerged berm	0.12	924.0	0	included in permanent pool volume
Water Quality Extended Detention (WQ_v -ED)	4" pipe, sized to 3.7" equivalent diameter	0.72	926.0	0.36	part of WQ_v , above perm. pool, discharge is average release rate over 24 hours
Streambank Protection (SP_v -ED)	6" pipe sized to 5.0" equivalent diameter	2.66	929.0	1.34	volume above perm. pool, discharge is average release rate over 24 hours
Downstream Flood Protection (Q_p)	Four 8.5' x 2' slots on a 10' x 8' riser, 60" barrel.	4.88	931.0	280	volume above perm. pool
Extreme Flood Protection (Q_{f-100})	34' wide earth spillway	6.53	932.2	207	volume above perm. pool

See Figure 29.8 for profile through principal spillway of the facility.

See Figure 29.9 for a schematic of the riser.

Step 12: Prepare Vegetation and Landscaping Plan

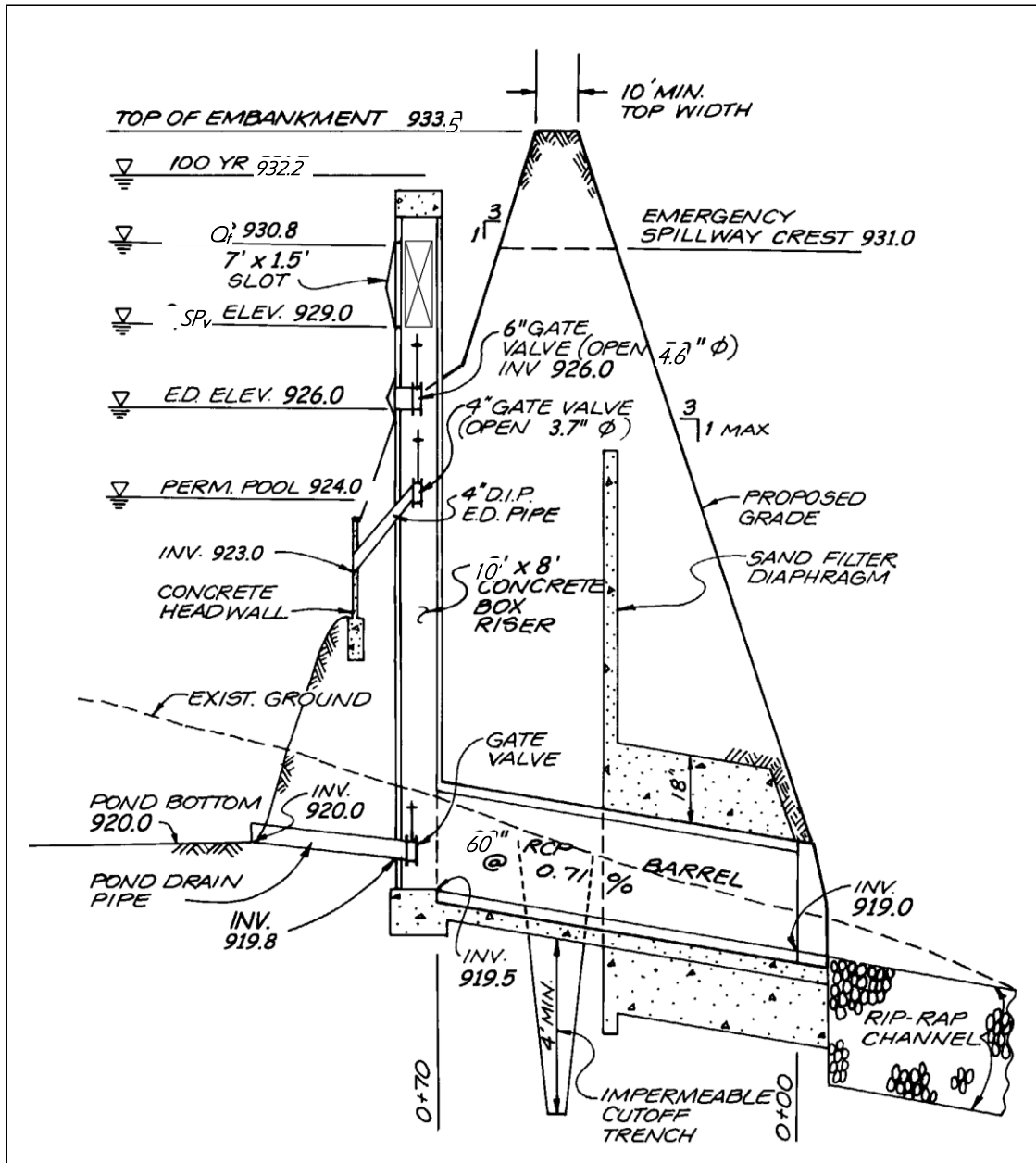

Figure 29.8 Profile of Principal Spillway

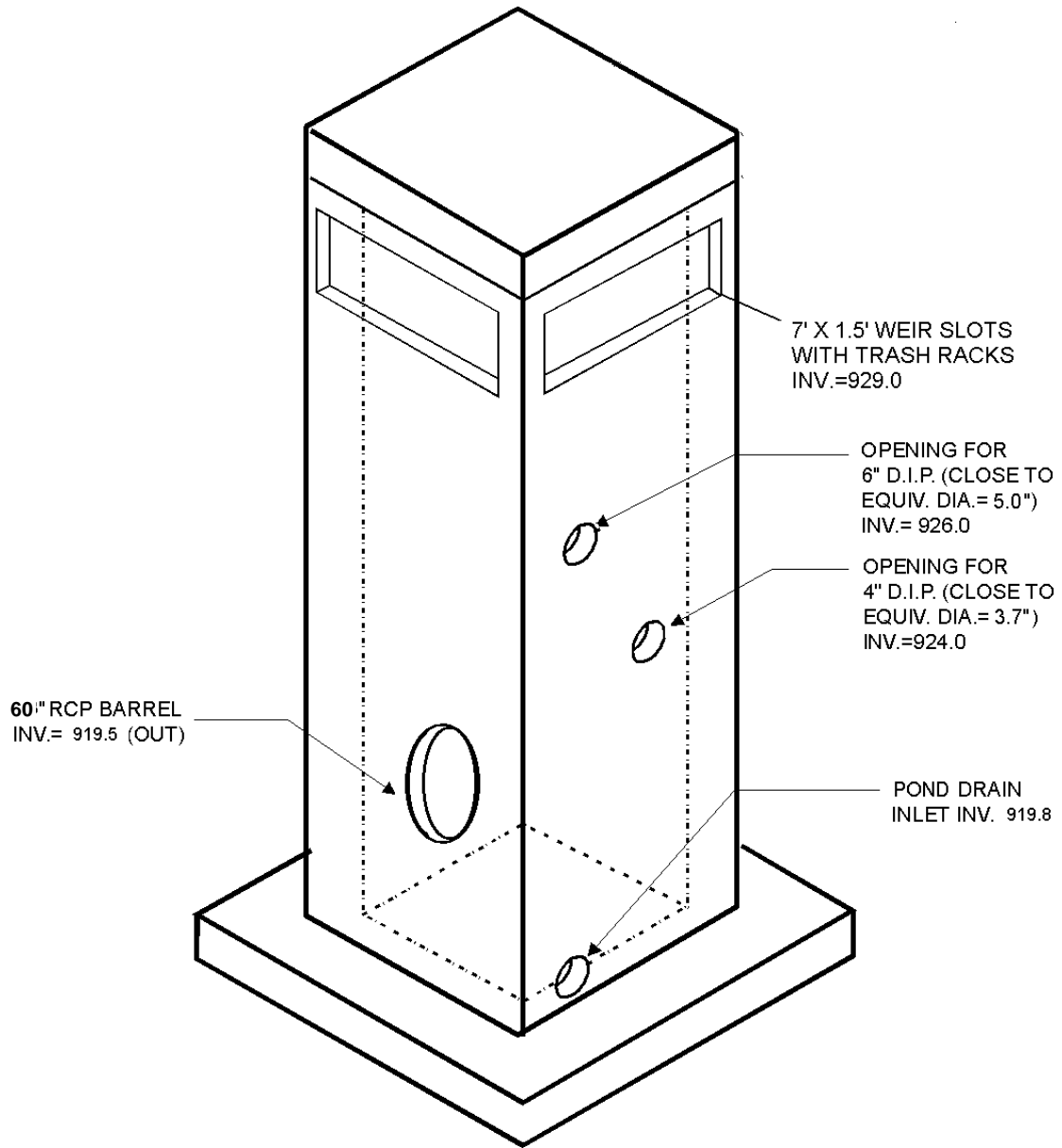

Figure 29.9 Schematic of Riser Detail

29.3 Bioretention Area Design Example

This example focuses on the design of a bioretention facility to meet the water quality treatment requirements of the Wellington Recreation Center. The design options chosen for this example are Option 1 for Water Quality Protection (WQ_v), Option 4 for Streambank Protection (SP_v), and Option 4 for Flood Control (Q_{p100}). Streambank Protection and Flood Control are not addressed in this example other than quantification of preliminary storage volume and peak discharge requirements. It is assumed that the designer can refer to the previous pond example in order to extrapolate the necessary information to determine and design the required storage and outlet structures to meet these criteria. In general, the primary function of bioretention is to provide water quality treatment and not large storm attenuation. As such, flows in excess of the water quality volume are typically routed to bypass the facility or pass through the facility. Where quantity control is required, the bypassed flows can be routed to conventional detention basins (or some other facility such as underground storage vaults). Under some conditions, Streambank Protection storage can be provided by bioretention facilities. The layout of the Wellington Recreation Center is shown in Figure 29.10.

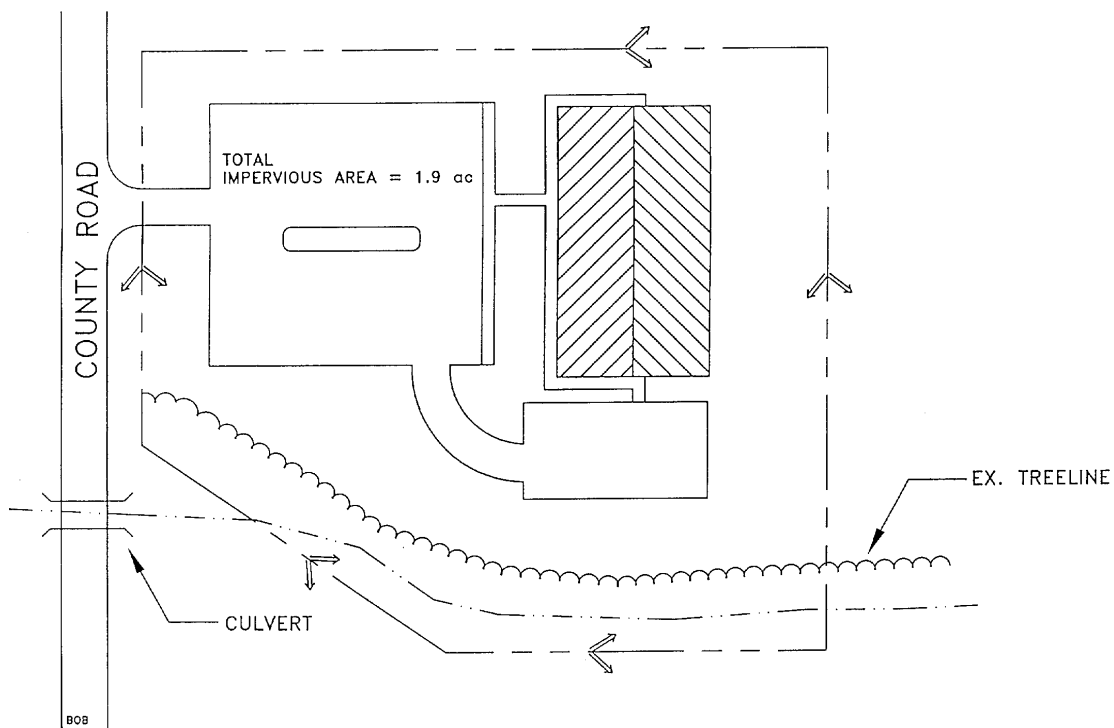

Figure 29.10 Wellington Recreation Center Site Plan

Where V_s equals streambank protection storage (SP_v) and V_r equals the volume of runoff in inches.

$$V_s/V_r = 0.65$$

$$\text{Therefore, } V_s = SP_v = 0.65(1.74''(1/12)(3 \text{ ac})) = 0.28 \text{ ac-ft} = 12,317 \text{ ft}^3$$

Analyze for Safe Passage of 100 Year Design Storm (Q_f):

At final design, prove that discharge conveyance channel is adequate to convey the 100-year event and discharge to receiving waters, or handle it with a peak flow control structure, typically the same one used for the 25 year storm flood protection control.

Symbol	Control Volume	Volume Required (cubic feet)	Notes
WQ_v	Water Quality	8,102	
SP_v	Streambank Protection	12,317	
Q_f	Extreme Flood Protection	NA	Provide safe passage for the 100-year event in final design

PEAK DISCHARGE SUMMARY				
JOB:	Wellington Recreation Center			EWB
DRAINAGE AREA NAME:	Post-Development Conditions			3-Jan-00
COVER DESCRIPTION	SOIL GROUP A, B, C, D?	C from TABLE 1.6 Hydrology Section	CN from TABLE 1.9 Hydrology Section	AREA (in acres)
open space (good cond.)	D		80	0.50
woods (good cond.)	D		70	0.60
impervious area	D		98	1.90
AREA SUBTOTALS:				38.00
Time of Concentration	Surface Cover	Manning 'n'	Flow Length	Slope
2-Yr 24 Hr Rainfall = 3.6"	Cross Section	Wetted Per	Avg Velocity	Tt (hrs)
Sheet Flow	dense grass	'n'= 0.24	50 ft	1.50%
				0.14 hrs
Shallow Flow	paved		600 ft	2.00%
			2.87 fps	0.06 hrs
Channel Flow		'n'=0.024	50 ft	2.00%
Hydraulic Radius	X-S estimated	WP estimated	7.25 fps	0.00 hrs
Total Area in Acres =	3.00	Total Sheet	Total Shallow	Total Channel
Weighted CN =	91	Flow =	Flow =	Flow =
Time of Concentration =	0.20 hrs	0.14 hrs.	0.06 hrs.	0.00 hrs.
Pond Factor =	1	RAINFALL TYPE II		
STORM	Precipitation (P) inches	Runoff (Q)	Qp, PEAK DISCHARGE (cfs)	
1 Year	2.64	1.74	6.7	
2 Year	3.60	2.64	10.4	
5 Year	5.04	4.02	16.0	
10 Year	6.00	4.96	20.0	
25 Year	7.20	6.14	25.0	
50 Year	8.40	7.32	31.0	
100 Year	9.84	8.75	37.0	

Figure 29.12 Wellington Recreation Center Post-Developed Conditions

Step 2: Determine if the development site and conditions are appropriate for the use of a bioretention area.

Site Specific Data:

Existing ground elevation at the facility location is 922.0 feet, mean sea level. Soil boring observations reveal that the seasonally high water table is at 913.0 feet and underlying soil is predominately clay. Adjacent creek invert is at 912.0 feet.

Step 3: Confirm local design criteria and applicability

There are no additional criteria that must be met for this design.

Step 4: Compute WQ_v peak discharge (Q_{wq})

Step 5: Size flow diversion structure, if needed

Bioretention areas can be either on or off-line. On-line facilities are generally sized to receive, but not necessarily treat, the 25-year event. Off-line facilities are designed to receive a more or less exact flow rate through a weir, channel, manhole, “flow splitter”, etc. This facility is situated to receive direct runoff from grass areas and parking lot curb openings and piping for the 25-year event (25.0 cfs), and *no special flow diversion structure is incorporated.*

Step 6: Determine size of bioretention ponding / filter area

$$A_f = (WQ_v) (d_f) / [(k) (h_f + d_f) (t_f)]$$

where:

- A_f = surface area of filter bed (ft²)
- d_f = filter bed depth (ft)
- k = coefficient of permeability of filter media (ft/day)
- h_f = average height of water above filter bed (ft)
- t_f = design filter bed drain time (days) (48 hours is recommended)

$$A_f = (8,102 \text{ ft}^3)(5') / [(0.5'/\text{day}) (0.25' + 5') (2 \text{ days})] \text{ (With } k = 0.5'/\text{day, } h_f = 0.25', t_f = 2 \text{ days)}$$

$$A_f = \underline{7,716 \text{ sq ft}}$$

Step 7: Set design elevations and dimensions of facility

Assume a roughly 2 to 1 rectangular shape. Given a filter area requirement of 7,716 sq ft, say facility is roughly 65' by 120'. See Figure 29.13. Set top of facility at 921.0 feet, with the berm at 922.0 feet. The facility is 5' deep, which will allow 3' of freeboard over the seasonally high water table. See Figure 29.14 for a typical section of the facility.

Step 8: Design conveyance to facility (off-line systems)

This facility is not designed as an off-line system.

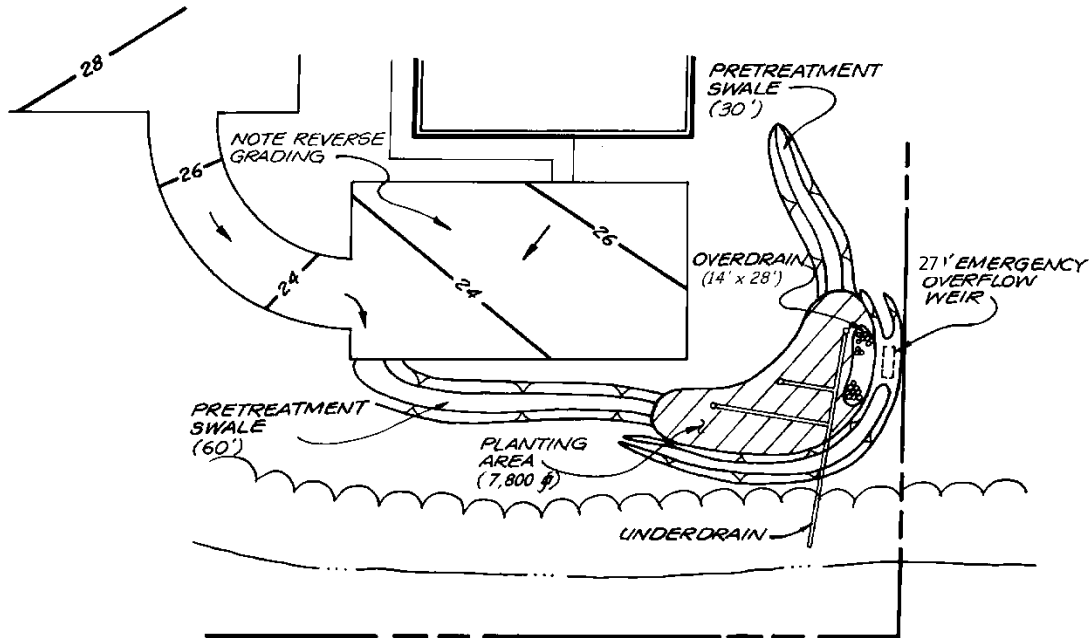

Figure 29.13 Plan View of Bioretention Facility

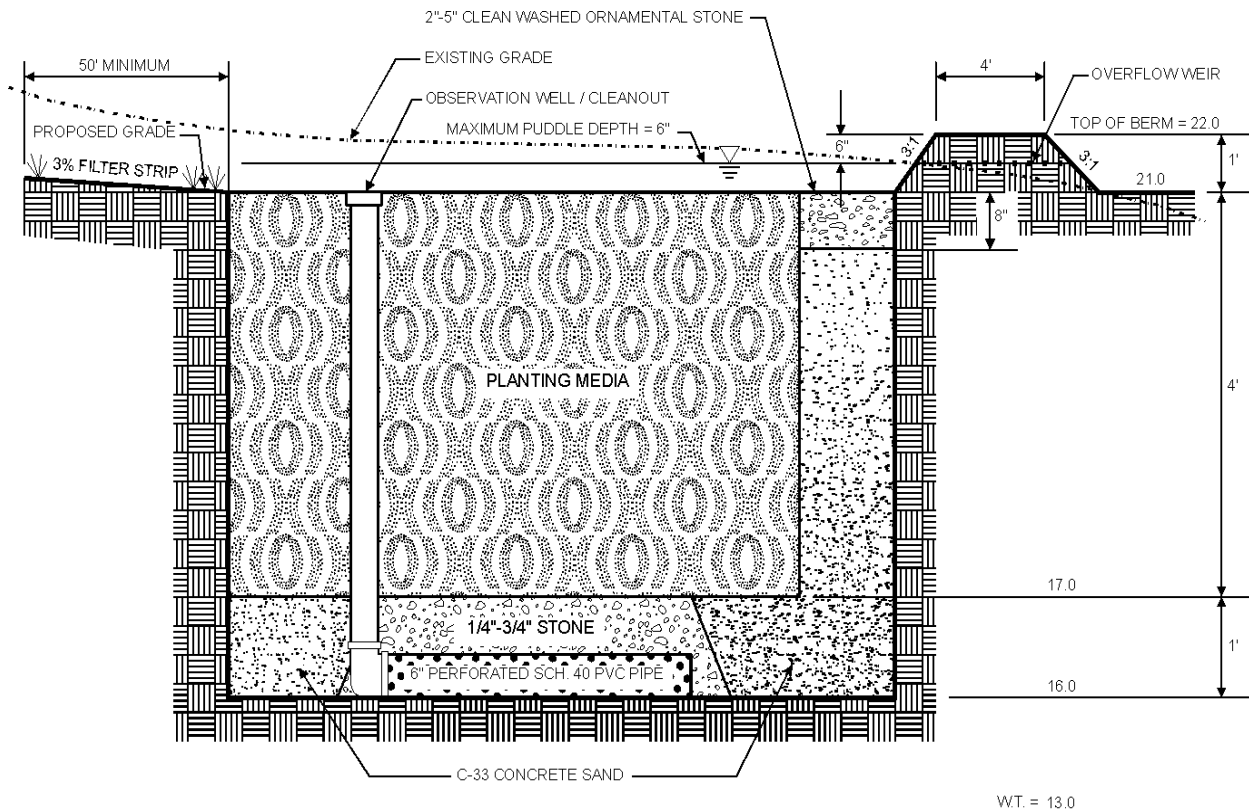

Figure 29.14 Typical Section of Bioretention Facility

Step 9: Design pretreatment

Pretreat with a grass channel, based on guidance provided in Table 29.4, below. For a 3.0 acre drainage area, 63% imperviousness, and slope less than 2.0%, provide a 90' grass channel at 1.5% slope. The value from Table 29.4 is 30' for a one acre drainage area.

Parameter	≤ 33% Impervious		Between 34% & 66% Impervious		≥ 67% Impervious		Notes
	≤2%	≥2%	≤2%	≥2%	≤2%	≥2%	
Slope	≤2%	≥2%	≤2%	≥2%	≤2%	≥2%	Max slope = 4%
Grassed channel min. length (feet)	25	40	30	45	35	50	Assumes a 2' wide bottom width

Step 10: Size underdrain area

Base underdrain design on 10% of the A_f or 772 sq ft. Using 6" perforated plastic pipes surrounded by a three-foot-wide gravel bed, 10' on center (o.c.). See Figures 29.5 and 29.6.

$(772 \text{ sq ft})/3'$ per foot of underdrain = 257', say 260' of perforated underdrain

Step 11: Design emergency overflow

To ensure against the planting media clogging, design a small ornamental stone window of 2" to 5" stone connected directly to the sand filter layer. This area is based on 5% of the A_f or 386 sq ft. Say 14' by 28'. See Figures 29.5 and 29.6.

The parking area, curb and gutter are sized to convey the 25-year event to the facility. Should filtering rates become reduced due to facility age or poor maintenance, an overflow weir is provided to pass the 25-year event. Size this weir with 6" of head, using the weir equation.

$$Q = CLH^{3/2}$$

Where C = 2.65 (smooth crested grass weir)

$$Q = 25.0 \text{ cfs}$$

$$H = 6''$$

$$\text{Solve for L: } L = Q / [(C) (H^{3/2})] \text{ or } (25.0 \text{ cfs}) / [(2.65) (.5)^{1.5}] = 26.7' \text{ (say 27')}$$

Outlet protection in the form of riprap or a plunge pool/stilling basin should be provided to ensure non-erosive velocities. See Figures 29.5 and 29.6.

Step 12: Prepare Vegetation and Landscaping Plan

Choose plants based on factors such as whether native or not, resistance to drought and inundation, cost, aesthetics, maintenance, etc. Select species locations (i.e., on center planting distances) so species will not "shade out" one another. Do not plant trees and shrubs with extensive root systems near pipe work. A potential plant list is presented in the [Landscape Technical Manual](#).

29.4 Sand Filter Design Example

This example focuses on the design of a surface sand filter to meet the water quality treatment requirements of the Falcon Creek Community Center. The design options chosen for this example are Option 1 for Water Quality Protection (WQ_v), Option 4 for Streambank Protection (SP_v), and Option 4 for Flood Control (Q_{p100}). Streambank Protection and Flood Control are not addressed in this example other than quantification of preliminary storage volume and peak discharge requirements. It is assumed that the designer can refer to the previous pond example in order to extrapolate the necessary information to determine and design the required storage and outlet structures to meet these criteria. In general, the primary function of sand filters is to provide water quality treatment and not large storm attenuation. As such, flows in excess of the water quality volume are typically routed to bypass the facility. Where quantity control is required, the bypassed flows can be routed to conventional detention basins (or some other facility such as underground storage vaults). The layout of the Falcon Creek Community Center is shown in Figure 29.15.

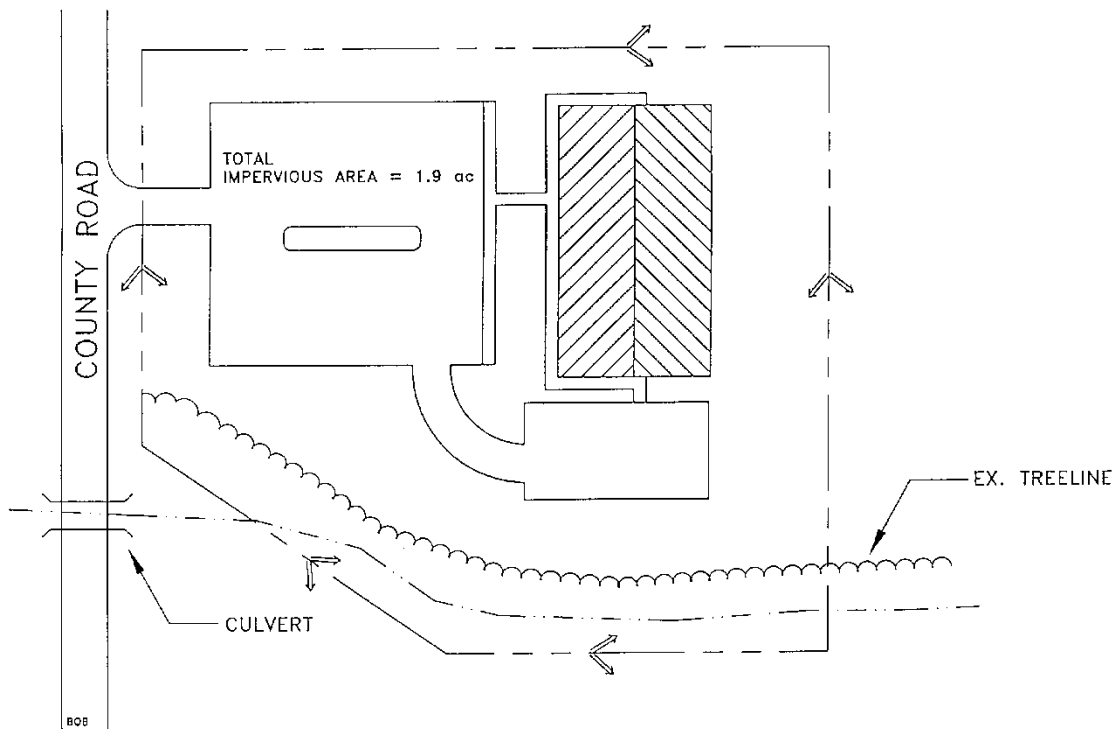

Figure 29.15 Falcon Creek Community Center Site Plan

Base Data	Hydrologic Data	
Site Area = Total Drainage Area (A) = 3.0 ac	Pre	Post
Impervious Area = 1.9 ac; or $I = 1.9/3.0 = 63.3\%$	CN	78
Soils Type "D" Dallas County	t_c	0.41 hr
		0.16 hr

Computation of Preliminary Stormwater Storage Volumes and Peak Discharges

Step 1: Compute runoff control volumes from the *integrated* Design Focus Areas

Compute Water Quality Volume (WQ_v):

- Compute Runoff Coefficient, R_v

$$R_v = 0.05 + (63.3) (0.009) = 0.62$$

- Compute WQ_v

$$\begin{aligned} WQ_v &= (1.5") (R_v) (A) / 12 \\ &= (1.5") (0.62) (3.0 \text{ ac}) (43,560 \text{ ft}^2/\text{ac}) (1\text{ft}/12\text{in}) \\ &= \underline{8,102 \text{ ft}^3} = \underline{0.186 \text{ ac-ft}} \end{aligned}$$

Compute Stream Streambank Protection Volume, (SP_v):

For stream streambank protection, provide 24 hours of extended detention for the 1-year event.

- **Develop Site Hydrologic and Hydrologic Input Parameters and Perform Preliminary Hydrologic Calculations**

Per Figures 29.16 and 29.17. Note that any hydrologic models using SCS procedures, such as TR-20, HEC-HMS, or HEC-1, can be used to perform preliminary hydrologic calculations

Condition	CN	Q _{1-year} <i>Inches</i>	Q _{1-year} <i>cfs</i>	Q _{100 year} <i>cfs</i>
Pre-developed	78	0.88	2.2	20.0
Post-Developed	91	1.74	7.3	39.0

- Utilize modified TR-55 approach to compute streambank protection storage volume

Initial abstraction (I_a) for CN of 91 is 0.198: (TR-55) [I_a = (200/CN - 2)]

$$I_a/P = (0.198) / 2.64 \text{ inches} = 0.075$$

$$T_c = 0.16 \text{ hours}$$

$$q_u = 900 \text{ csm/in}$$

Knowing q_u and T (extended detention time), find q_o/q_i for a Type II rainfall distribution.

Peak outflow discharge/peak inflow discharge (q_o/q_i) = 0.02

$$V_s/V_r = 0.683 - 1.43(q_o/q_i) + 1.64(q_o/q_i)^2 - 0.804(q_o/q_i)^3$$

Where V_s equals streambank protection storage (SP_v) and V_r equals the volume of runoff in inches.

$$V_s/V_r = 0.655$$

Therefore, V_s = SP_v = 0.655(1.74")(1/12)(3 ac) = 0.285 ac-ft = 12,415 ft³

- Define the average extended detention Release Rate

The above volume, 0.30 ac-ft, is to be released over 24 hours.

$$(0.30 \text{ ac-ft} \times 43,560 \text{ ft}^2/\text{ac}) / (24 \text{ hrs} \times 3,600 \text{ sec/hr}) = 0.15 \text{ cfs}$$

Analyze for Safe Passage of 100 Year Design Storm (Q_f):

At final design, prove that discharge conveyance channel is adequate to convey the 100-year event and discharge to receiving waters, or handle it with a peak flow control structure, typically the same one used for the 25-year storm flood protection control.

Symbol	Control Volume	Volume Required (cubic feet)	Notes
WQ _v	Water Quality	8,102	
SP _v	Streambank Protection	12,415	
Q _f	Extreme Flood Protection	NA	Provide safe passage for the 100-year event in final design

PEAK DISCHARGE SUMMARY				
JOB:	Falcon Creek Center			EWB
DRAINAGE AREA NAME:	Pre-Developed Conditions			3-Jan-00
COVER DESCRIPTION	SOIL GROUP A, B, C, D?	C from TABLE 1.6 Hydrology Section	CN from TABLE 1.9 Hydrology Section	AREA (in acres)
meadows (good cond.)	D		78	2.40
woods (good cond.)	D		77	0.60
			AREA SUBTOTALS:	3.00
Time of Concentration	Surface Cover	Manning 'n'	Flow Length	Slope
2-Yr 24 Hr Rainfall = 3.6"	Cross Section	Wetted Per	Avg Velocity	Tt (hrs)
Sheet Flow	Dense grass	'n'= 0.24	150 ft	2.50%
				0.35 hrs
Shallow Flow	unpaved		500 ft	2.00%
			2.28 fps	0.06 hrs
Channel Flow				
Hydraulic Radius				
Total Area in Acres =	3.00	Total Sheet	Total Shallow	Total Channel
Weighted CN =	78	Flow =	Flow =	Flow =
Time of Concentration =	0.41 hrs	0.35 hrs.	0.06 hrs.	0.00 hrs.
Pond Factor =	1	RAINFALL TYPE II		
STORM	Precipitation (P) inches	Runoff (Q)	Qp, PEAK DISCHARGE (cfs)	
1 Year	2.64	0.88	2.2	
2 Year	3.60	1.57	4.2	
5 Year	4.8	2.54	6.9	
10 Year	5.76	3.37	9.3	
25 Year	7.20	4.66	13.0	
50 Year	8.40	5.76	17.0	
100 Year	9.6	6.98	20.0	

Figure 29.16 Falcon Creek Community Center Pre-Developed Conditions

PEAK DISCHARGE SUMMARY				
JOB:	Falcon Creek Center			EWB
DRAINAGE AREA NAME:	Post-Developed Conditions			3-Jan-00
COVER DESCRIPTION	SOIL GROUP A, B, C, D?	C from TABLE 1.6 Hydrology Section	CN from TABLE 1.9 Hydrology Section	AREA (in acres)
open space (good cond.)	D		78	0.50
woods (good cond.)	D		77	0.60
impervious	D		98	1.90
	AREA SUBTOTALS:			3.00
Time of Concentration	Surface Cover	Manning 'n'	Flow Length	Slope
2-Yr 24 Hr Rainfall = 3.6"	Cross Section	Wetted Per	Avg Velocity	Tt (hrs)
Sheet Flow	short grass	'n' = 0.15	50 ft	1.50%
				0.10 hrs
Shallow Flow	paved		600 ft	2.00%
			2.87 fps	0.06 hrs
Channel Flow Hydraulic Radius = 0.75		'n' = 0.024	50 ft	2.00%
	X-S estimated	WP estimated	7.25 fps	0.00hrs
Total Area in Acres =	3.00	Total Sheet	Total Shallow	Total Channel
Weighted CN =	91	Flow =	Flow =	Flow =
Time of Concentration =	0.16 hrs	0.10 hrs.	0.06 hrs.	0.00 hrs.
Pond Factor =	1	RAINFALL TYPE II		
STORM	Precipitation (P) inches	Runoff (Q)	Qp, PEAK DISCHARGE (cfs)	
1 Year	2.64	1.74	7.3	
2 Year	3.60	2.64	11.0	
5 Year	4.8	3.79	17.0	
10 Year	5.76	4.72	21.0	
25 Year	7.20	6.14	27.0	
50 Year	8.40	7.32	33.0	
100 Year	9.6	8.51	39.0	

Figure 29.17 Falcon Creek Community Center Post-Developed Conditions

Step 2: Determine if the development site and conditions are appropriate for the use of a surface sand filter.

Site Specific Data:

Existing ground elevation at the facility location is 22.0 feet, mean sea level. Soil boring observations reveal that the seasonally high water table is at 13.0 feet. Adjacent creek invert is at 12.0.

Step 3: Confirm local design criteria and applicability.

There are no additional requirements for this site.

Step 4: Compute WQ_v peak discharge (Q_{wq}) & Head

- Water Quality Volume:

WQ_v previously determined to be 8,102 cubic feet.

- Determine available head (See Figure 29.18)

Low point at parking lot is 23.5. Subtract 2' to pass Q_{100} discharge (39) and a half foot for channel to facility (21.0). Low point at stream invert is 12.0. Set outfall underdrain pipe 2' above stream invert and add 0.5' to this value for drain (14.5). Add to this value 8" for the gravel blanket over the underdrains, and 18" for the sand bed (16.67). The total available head is 21.0 - 16.67 or 4.33 feet. Therefore, the average depth, h_f , is $(h_f) = 4.33' / 2$, and $h_f = 2.17'$.

The peak rate of discharge for the water quality design storm is needed for the sizing of off-line diversion structures, such as sand filters and grass channels. Conventional SCS methods have been found to underestimate the volume and rate of runoff for rainfall events less than 2". This discrepancy in estimating runoff and discharge rates can lead to situations where a significant amount of runoff bypasses the filtering treatment practice due to an inadequately sized diversion structure and leads to the design of undersized bypass channels.

The following procedure can be used to estimate peak discharges for small storm events. It relies on the volume of runoff computed using the Small Storm Hydrology Method (Pitt, 1994) and utilizes the NRCS, TR-55 Graphical Peak Discharge Method (USDA, 1986). A brief description of the calculation procedure is presented below.

- Using the water quality volume (WQ_v), a corresponding Curve Number (CN) is computed utilizing *Equation 1.8 of the Hydrology Technical Manual*:

$$CN = 1000/[10 + 5P + 10Q - 10(Q^2 + 1.25QP)^{1/2}]$$

where P = rainfall, in inches (use 1.5" for the Water Quality Storm)
and Q = runoff volume, in inches (equal to $WQ_v \div \text{area}$)

- Once a CN is computed, the time of concentration (t_c) is computed
- Using the computed CN, t_c and drainage area (A), in acres; the peak discharge (Q_{wq}) for the Water Quality Storm is computed (based on the procedures identified in *Section 1.4 of the Water Quality Technical Manual* (typically Type II in the North Central Texas region).
- Read initial abstraction (I_a), compute I_a/P
- Read the unit peak discharge (q_u) for appropriate t_c

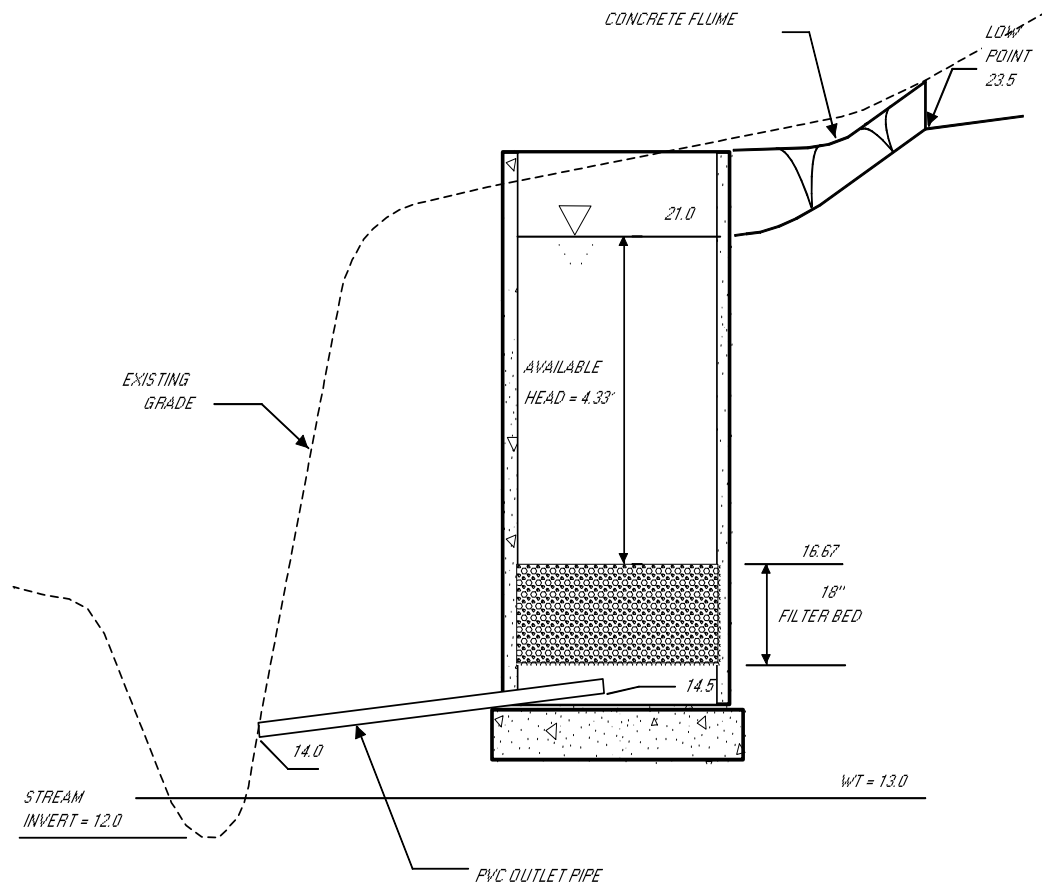

Figure 29.18 Available Head Diagram

- Using the water quality volume (WQ_v), compute the water quality peak discharge (Q_{wq})

$$Q_{wq} = q_u \cdot A \cdot WQ_v \quad (29.2)$$

where

Q_{wq} = the peak discharge, in cfs

q_u = the unit peak discharge, in cfs/mi²/inch

A = drainage area, in square miles

WQ_v = Water Quality Volume, in watershed inches

For this example, the steps are as follows:

Compute modified CN for 1.5" rainfall

$$P = 1.5''$$

$$Q = WQ_v \div \text{area} = (8,102 \text{ ft}^3 \div 3 \text{ ac} \div 43,560 \text{ ft}^2/\text{ac} \times 12 \text{ in/ft}) = 0.74''$$

$$\begin{aligned} \text{CN} &= 1000/[10+5P+10Q-10(Q^2+1.25*Q*P)^{1/2}] \\ &= 1000/[10+5*1.5+10*0.74-10(0.74^2+1.25*0.74*1.5)^{1/2}] \\ &= 95.01 \end{aligned}$$

Use CN = 95

For CN = 95 and the $T_c = 0.16$ hours, compute the Q_p for a 1.5" storm. With the CN = 95, a 1.5" storm will produce 0.74" of runoff. $I_a = 0.105$, therefore $I_a/P = 0.105/1.5 = 0.088$. From [Section 1.0 of the Hydrology](#)

Technical Manual, $q_u = 625$ csm/in, and therefore $Q_{wq} = (900 \text{ csm/in}) (3.0 \text{ ac}/640\text{ac/sq mi.}) (0.74") = \underline{3.1}$ cfs.

Step 5: Size flow diversion structure (see Figure 29.19):

Size a low flow orifice to pass 3.1 cfs with 1.5' of head using the Orifice equation.

$$Q = CA(2gh)^{1/2}; 3.1 \text{ cfs} = (0.6) (A) [(2) (32.2 \text{ ft/s}^2) (1.5')]^{1/2}$$

$$A = 0.53 \text{ sq ft} = \pi d^2/4; d = 0.8' \text{ or } 9.8"; \text{ use } \underline{10 \text{ inches}}$$

Size the 100-year overflow as follows: the 100-year wsel is set at 23.0. Use a concrete weir to pass the 100-year flow (39.0 cfs) into a grassed overflow channel using the Weir equation. Assume 2' of head to pass this event. Overflow channel should be designed to provide sufficient energy dissipation (e.g., riprap, plunge pool, etc.) so that there will be non-erosive velocities.

$$Q = CLH^{3/2}$$

$$39 = 3.1 (L) (2')^{1.5}$$

$$L = 4.45'; \text{ use } \underline{L = 4'-5"} \text{ which sets flow diversion chamber dimension.}$$

$$\text{Weir wall elev.} = 21.0. \text{ Set low flow invert at } 21.0 - [1.5' + (0.5 \cdot 10'' \cdot 1\text{ft}/12'')] = 19.08.$$

Step 6: Size filtration bed chamber (see Figure 29.20):

From Darcy's Law: $A_f = WQ_v (d_f) / [k (h_f + d_f) (t_f)]$

where $d_f = 18''$

$$k = 3.5 \text{ ft/day}$$

$$h_f = 2.17'$$

$$t_f = 40 \text{ hours}$$

$$A_f = (8,102 \text{ cubic feet}) (1.5') / [3.5 (2.17' + 1.5') (40\text{hr}/(24\text{hr}/\text{day}))]$$

$$A_f = \underline{567.7 \text{ sq ft}}; \text{ using a 2:1 ratio, say filter is } \underline{17' \text{ by } 34'} (= 578 \text{ sq ft})$$

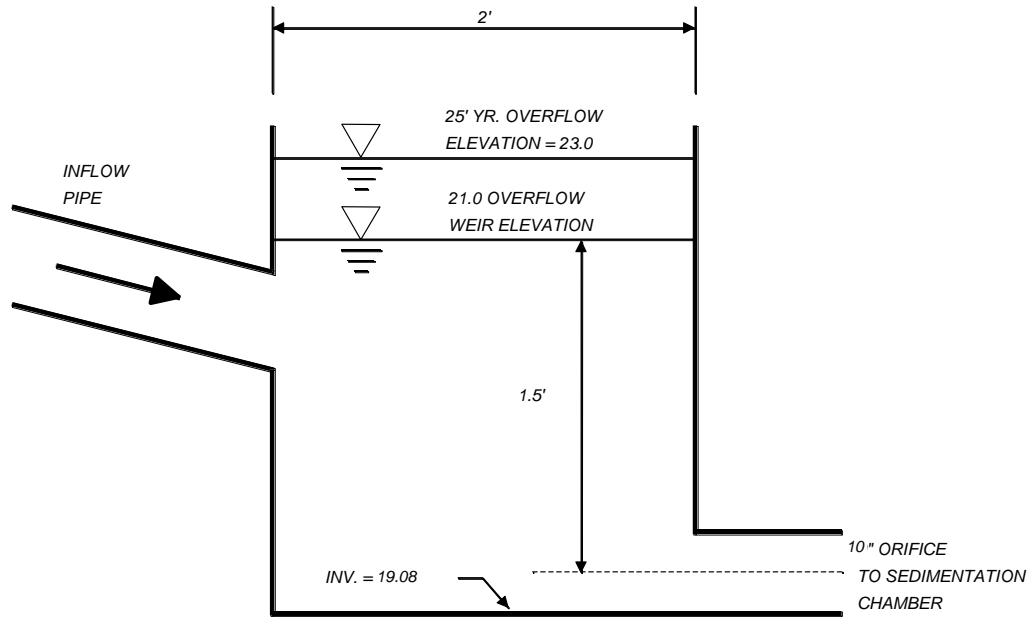

Figure 29.19 Flow Diversion Structure

Step 7: Size sedimentation chamber

From Camp-Hazen equation, for $I < 75\%$: $A_s = 0.066 (WQ_v)$

$A_s = 0.066 (8,102 \text{ cubic ft})$ or 535 sq ft

given a width of 17 feet, the length will be $535/17'$ or 31.5 feet (use 17' x 32')

Step 8: Compute V_{\min}

$V_{\min} = \frac{3}{4}(WQ_v)$ or $0.75 (8,102 \text{ cubic feet}) = \underline{6,077 \text{ cubic feet}}$

Step 9: Compute storage volumes within entire facility and sedimentation chamber orifice size:

Volume within filter bed (V_f): $V_f = A_f (d_f) (n)$; $n = 0.4$ for sand

$V_f = (578 \text{ sq ft}) (1.5') (0.4) = \underline{347 \text{ cubic feet}}$

Temporary storage above filter bed ($V_{f\text{-temp}}$): $V_{f\text{-temp}} = 2 h_f A_f$

$V_{f\text{-temp}} = 2 (2.17') (578 \text{ sq ft}) = \underline{2,509 \text{ cubic feet}}$

Compute remaining volume for sedimentation chamber (V_s):

$V_s = V_{\min} - [V_f + V_{f\text{-temp}}]$ or $6,077 - [347 + 2,509] = \underline{3,221 \text{ cubic feet}}$

Compute height in sedimentation chamber (h_s): $h_s = V_s/A_s$

$(3,221 \text{ cubic ft})/(17' \times 32') = 5.9'$ which is larger than the head available (4.33'); increase the size of the settling chamber, using 4.33' as the design height;

$(3,221 \text{ cubic ft})/4.33' = 744 \text{ sq ft}$; $744/17'$ yields a length of 43.8 feet (say 44')

New sedimentation chamber dimensions are 17' by 44'

With adequate preparation of the bottom of the settling chamber (rototil earth, place gravel, then surge stone), the bottom can infiltrate water into the substrate. The runoff will enter the groundwater directly without treatment. The stone will eventually clog without protection from settling solids, so use a

removable geotextile to facilitate maintenance. Note that there is 2.17' of freeboard between bottom of recharge filter and water table.

Provide perforated standpipe with orifice sized to release volume (within sedimentation basin) over a 24 hr period (see Figure 29.21). Average release rate equals $3,221 \text{ ft}^3/24 \text{ hr} = 0.04 \text{ cfs}$

Equivalent orifice size can be calculated using orifice equation:

$$Q = CA(2gh)^{1/2}, \text{ where } h \text{ is average head, or } 4.33'/2 = 2.17'.$$

$$0.04 \text{ cfs} = 0.6 * A * (2 * 32.2 \text{ ft/s}^2 * 2.17 \text{ ft})^{1/2}$$

$$A = 0.005 \text{ ft}^2 = \pi D^2/4: \text{ therefore equivalent orifice diameter equals } 1".$$

Recommended design is to cap stand pipe with low flow orifice sized for 24 hr detention. Over-perforate pipe by a safety factor of 10 to account for clogging. Note that the size and number of perforations will depend on the release rate needed to achieve 24 hr detention. A multiple orifice stage-discharge relation needs to be developed for the proposed perforation configuration. Stand pipe should discharge into a flow distribution chamber prior to filter bed. Distribution chamber should be between 2 and 4 feet in length and same width as filter bed. Flow distribution to the filter bed can be achieved either with a weir or multiple orifices at constant elevation. See Figure 29.9 for stand pipe details.

Step 10: Design inlets, pretreatment facilities, underdrain system, and outlet structures

Step 11: Compute overflow weir sizes

Assume overflow that needs to be handled is equivalent to the 10" orifice discharge under a head of 3.5 ft (i.e., the head in the diversion chamber associated with the 100-year peak discharge).

$$Q = CA(2gh)^{1/2}$$

$$Q = 0.6(0.55 \text{ ft}^2)[(2)(32.2 \text{ ft/s}^2)(3.5 \text{ ft})]^{1/2}$$

$$Q = 4.91 \text{ cfs, say } 5.0 \text{ cfs}$$

For the overflow from the sediment chamber to the filter bed, size to pass 5 cfs.

Weir equation: $Q = CLh^{3/2}$, assume a maximum allowable head of 0.5'

$$5.0 = 3.1 * L * (0.5 \text{ ft})^{3/2}$$

$$L = 4.56 \text{ ft, Use } L = 4.75 \text{ ft.}$$

Similarly, for the overflow from the filtration chamber to the outlet of the facility, size to pass 5.0 cfs.

Weir equation: $Q = CLh^{3/2}$, assume a maximum allowable head of 0.5'

$$5.0 = 3.1 * L * (0.5 \text{ ft})^{3/2}$$

$$L = 4.56 \text{ ft, Use } L = 4.75 \text{ ft.}$$

Adequate outlet protection and energy dissipation (e.g., riprap, plunge pool, etc.) should be provided for the downstream overflow channel.

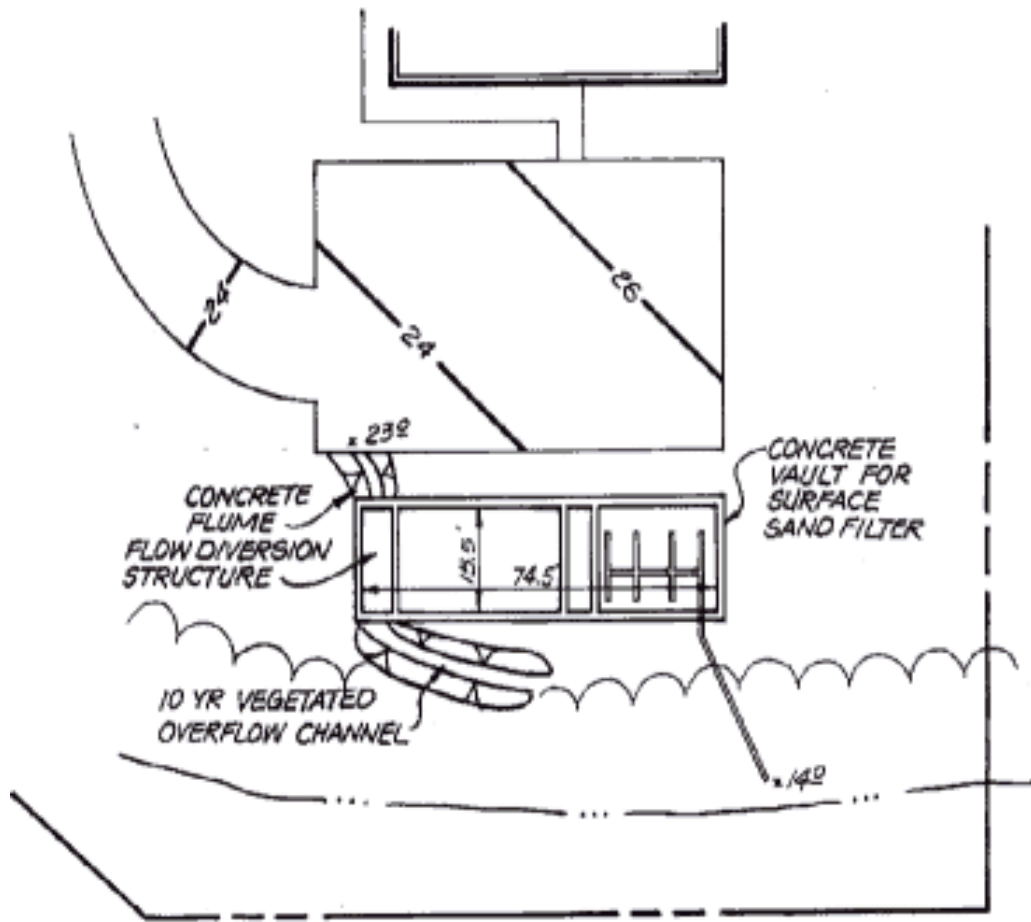

Figure 29.20 Surface Sand Filter Site Plan

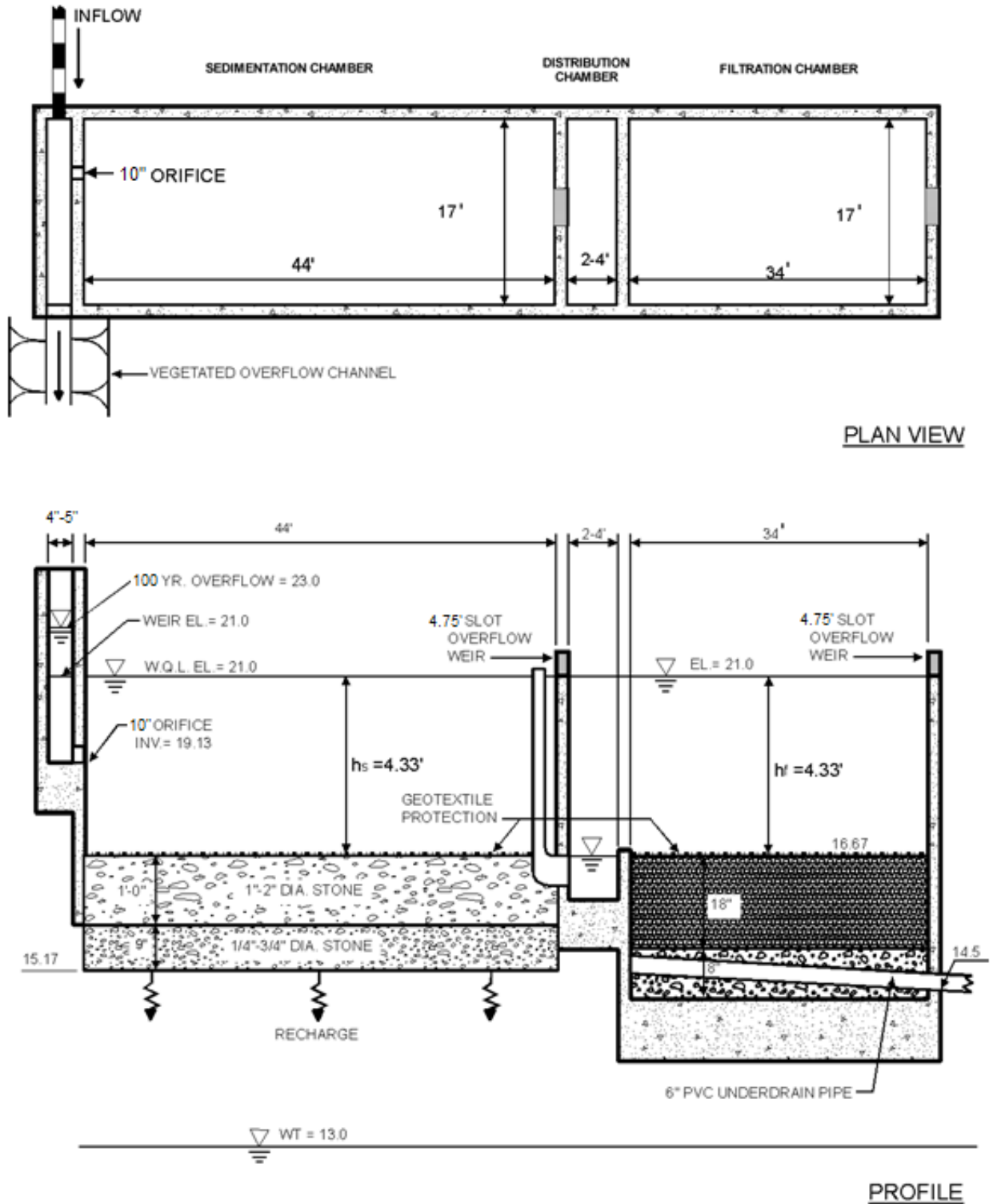

Figure 29.21 Plan and Profile of Surface Sand Filter

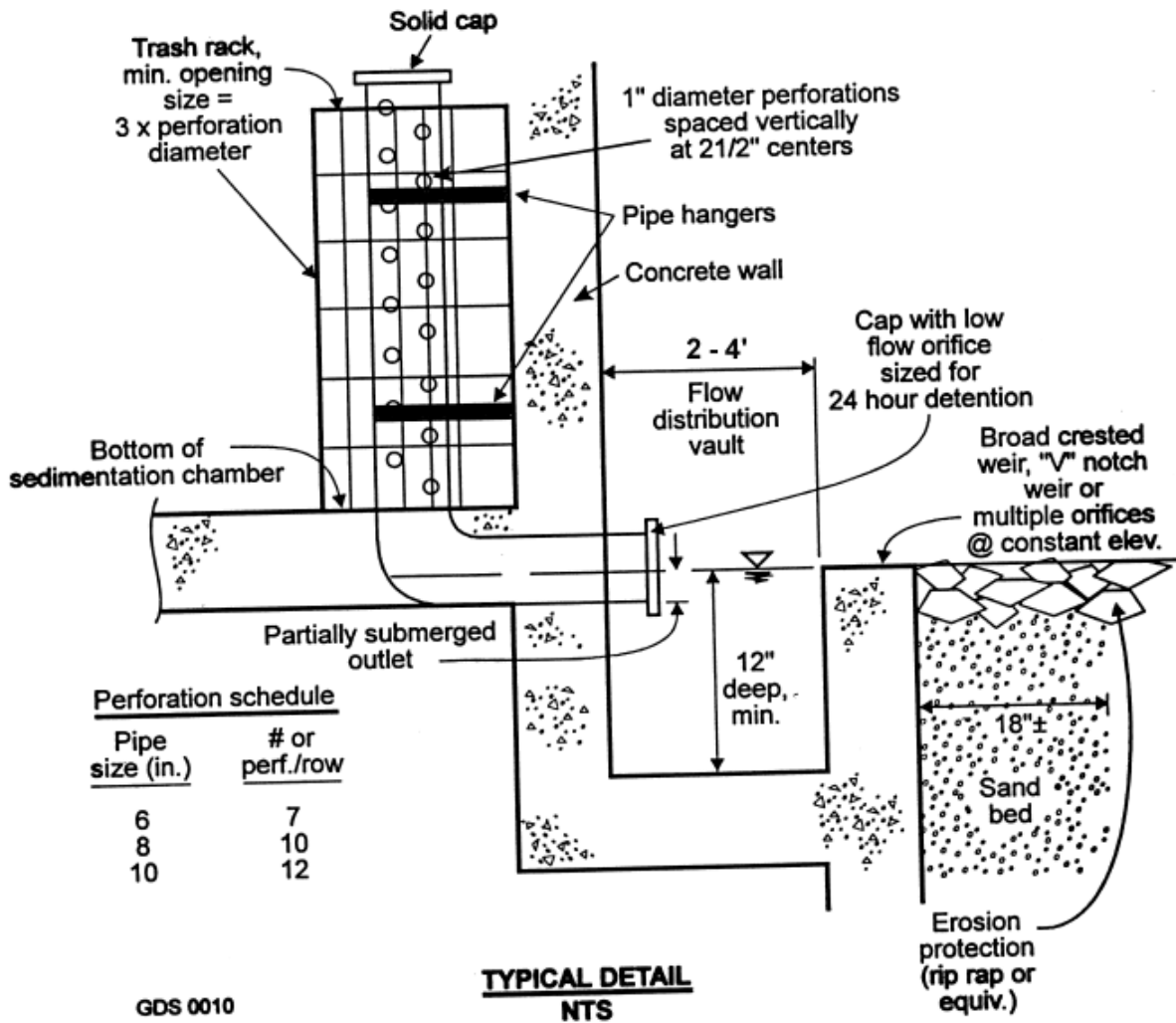

Figure 29.22 Perforated Stand Pipe Detail

29.5 Infiltration Trench Design Example

This example focuses on the design of an infiltration trench to meet the water quality treatment requirements of the site. The design options chosen for this example are Option 1 for Water Quality Protection (WQ_v), Option 4 for Streambank Protection (SP_v), and Option 4 for Flood Control (Q_{p100}). Streambank Protection and Flood Control are not addressed in this example other than quantification of preliminary storage volume and peak discharge requirements. It is assumed that the designer can refer to the previous pond example in order to extrapolate the necessary information to determine and design the required storage and outlet structures to meet these criteria. In general, the primary function of infiltration trenches is to provide water quality treatment and groundwater recharge and not large storm attenuation. As such, flows in excess of the water quality volume are typically routed to bypass the facility. Where quantity control is required, the bypassed flows can be routed to conventional detention basins (or some other facility such as underground storage vaults). The layout of the Cottonwood Creek Community Center is shown in Figure 29.23.

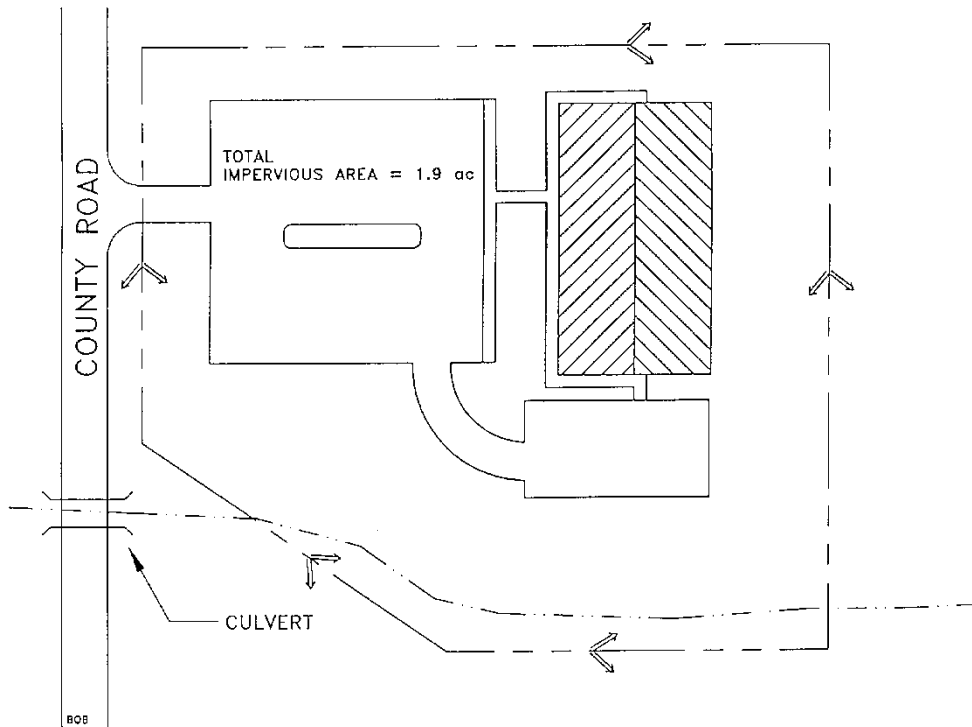

Figure 29.23 Cottonwood Creek Community Center Site Plan

Base Data		Hydrologic Data	
Site Area = Total Drainage Area (A) = 3.0 ac			
Impervious Area = 1.9 ac; or $I = 1.9/3.0 = 63.3\%$		CN	<u>Pre</u> <u>Post</u>
Soils Type "B" Wise County		t_c	55 82
			0.42 hr 0.16 hr

Step 1: Compute runoff control volumes from the *integrated* Design Focus Areas

Compute Water Quality Volume (WQ_v):

- Compute Runoff Coefficient, R_v
 $R_v = 0.05 + (63.3)(0.009) = 0.62$
- Compute WQ_v
 $WQ_v = (1.5") (R_v) (A) / 12$
 $= (1.5") (0.62) (3.0 \text{ ac}) (43,560 \text{ ft}^2/\text{ac}) (1\text{ft}/12\text{in})$
 $= 8,102 \text{ ft}^3 = 0.186 \text{ ac-ft}$

Compute Stream Streambank Protection Volume, (SP_v):

For stream streambank protection, provide 24 hours of extended detention for the 1-year event.

- **Develop Site Hydrologic and Hydrologic Input Parameters and Perform Preliminary Hydrologic Calculations**

Per Figures 29.24 and 29.25. Note that any hydrologic models using SCS procedures, such as TR-20, HEC-HMS, or HEC-1, can be used to perform preliminary hydrologic calculations

Condition	CN	Q _{1-year} <i>Inches</i>	Q _{1-year} <i>cfs</i>	Q _{100 year} <i>cfs</i>
Pre-developed	55	0.11	0.1	8.9
Post-Developed	82	1.1	4.4	29.0

- Utilize modified TR-55 approach to compute streambank protection storage volume

Initial abstraction (I_a) for CN of 82 is 0.44: (TR-55) [I_a = (200/CN - 2)]

$$I_a/P = (0.44)/ 2.64 \text{ inches} = 0.17$$

$$T_c = 0.17 \text{ hours}$$

$$q_u = 850 \text{ csm/in}$$

Knowing q_u and T (extended detention time), find q_o/q_i for a Type II rainfall distribution.

Peak outflow discharge/peak inflow discharge (q_o/q_i) = 0.02

$$V_s/V_r = 0.683 - 1.43(q_o/q_i) + 1.64(q_o/q_i)^2 - 0.804(q_o/q_i)^3$$

Where V_s equals streambank protection storage (SP_v) and V_r equals the volume of runoff in inches.

$$V_s/V_r = 0.655$$

$$\text{Therefore, } V_s = SP_v = 0.655(1.10")(1/12)(3 \text{ ac}) = 0.18 \text{ ac-ft} = 7,841 \text{ ft}^3$$

- Define the average extended detention Release Rate

The above volume, 0.18 ac-ft, is to be released over 24 hours.

$$(0.18 \text{ ac-ft} \times 43,560 \text{ ft}^2/\text{ac}) / (24 \text{ hrs} \times 3,600 \text{ sec/hr}) = 0.09 \text{ cfs}$$

Analyze for Safe Passage of 100 Year Design Storm (Q_r):

At final design, prove that discharge conveyance channel is adequate to convey the 100-year event and discharge to receiving waters, or handle it with a peak flow control structure.

Symbol	Control Volume	Volume Required (cubic feet)	Notes
WQ _v	Water Quality	8,102	
SP _v	Streambank Protection	7,841	
Q _f	Flood Protection	NA	Provide safe passage for the 100-year event in final design

PEAK DISCHARGE SUMMARY				
JOB:	Cottonwood Creek			EWB
DRAINAGE AREA NAME:	Pre-Developed Conditions			3-Jan-00
COVER DESCRIPTION	SOIL GROUP A, B, C, D?	C from TABLE 1.6 Hydrology Section	CN from TABLE 1.9 Hydrology Section	AREA (in acres)
meadow (good cond.)	B		55	3.00
AREA SUBTOTALS:				3.00
Time of Concentration	Surface Cover	Manning 'n'	Flow Length	Slope
2-Yr 24 Hr Rainfall = 3.36"	Cross Section	Wetted Per	Avg Velocity	Tt (hrs)
Sheet Flow	dense grass	'n'= 0.24	150ft	1.50%
				0.36 hrs
Shallow Flow	unpaved		500 ft	2.00%
			2.28 fps	0.06 hrs
Channel Flow				
Total Area in Acres =	3.00	Total Sheet	Total Shallow	Total Channel
Weighted CN =	55	Flow =	Flow =	Flow =
Time of Concentration =	0.42 hrs	0.36 hrs.	0.06 hrs.	0.00 hrs.
Pond Factor =	1	RAINFALL TYPE II		
STORM	Precipitation (P) inches	Runoff (Q)	Qp, PEAK DISCHARGE (cfs)	
1 Year	2.64	0.11	0.10	
2 Year	3.36	0.30	0.39	
5 Year	4.56	0.77	1.5	
10 Year	5.28	1.12	2.5	
25 Year	6.72	1.95	4.8	
50 Year	7.68	2.57	6.5	
100 Year	8.88	3.40	8.9	

Figure 29.24 Cottonwood Creek Community Center Pre-Developed Conditions

PEAK DISCHARGE SUMMARY				
JOB:	Cottonwood Creek			EWB
DRAINAGE AREA NAME:	Post-Developed Conditions			3-Jan-00
COVER DESCRIPTION	SOIL GROUP A, B, C, D?	C from TABLE 1.6 Hydrology Section	CN from TABLE 1.9 Hydrology Section	AREA (in acres)
meadow (good cond.)	B		55	1.10
impervious	B		98	1.90
AREA SUBTOTALS:				38.00
Time of Concentration	Surface Cover	Manning 'n'	Flow Length	Slope
2-Yr 24 Hr Rainfall = 3.36"	Cross Section	Wetted Per	Avg Velocity	Tt (hrs)
Sheet Flow	short grass	'n'= 0.15	50 ft	1.50%
				0.10 hrs
Shallow Flow	paved		600 ft	2.00%
			2.88 fps	0.06 hrs
Channel Flow		'n'= 0.24	50 ft	2.00%
Hydraulic Radius = 0.75	X-S estimated	WP estimated	7.25 fps	0.00 hrs
Total Area in Acres =	3.00	Total Sheet	Total Shallow	Total Channel
Weighted CN =	82	Flow =	Flow =	Flow =
Time of Concentration =	0.16 hrs	0.10 hrs.	0.06 hrs.	0.00 hrs.
Pond Factor =	1	RAINFALL TYPE II		
STORM	Precipitation (P) inches	Runoff (Q)	Qp, PEAK DISCHARGE (cfs)	
1 Year	2.64	1.10	4.4	
2 Year	3.36	1.67	6.8	
5 Year	4.56	2.69	11	
10 Year	5.28	3.33	14	
25 Year	6.72	4.65	20	
50 Year	7.68	5.56	24	
100 Year	8.88	6.70	29	

Figure 29.25 Cottonwood Creek Community Center Post-Developed Conditions

Step 2: Determine if the development site and conditions are appropriate for the use of an infiltration trench

Site Specific Data:

Table 29.7 presents site-specific data, such as soil type, percolation rate, and slope, for consideration in the design of the infiltration trench.

Criteria	Value
Soil	Sandy Loam
Percolation Rate	1"/hour
Ground Elevation at BMP	20'
Seasonally High Water Table	13'
Stream Invert	12'
Soil slopes	<1%

Step 3: Confirm local design criteria and applicability

Table 29.8, below, summarizes the requirements that need to be met to successfully implement infiltration practices. On this site, infiltration is feasible, with restrictions on the depth and width of the trench.

Criteria	Status
Infiltration rate (f_c) greater than or equal to 0.5 inches/hour.	Infiltration rate is 1.0 inches/hour. OK.
Soils have a clay content of less than 20% and a silt/clay content of less than 40%.	Sandy Loam meets both criteria.
Infiltration cannot be located on slopes greater than 6% or in fill soils.	Slope is <1%; not fill soils. OK.
Hotspot runoff should not be infiltrated.	Not a hotspot land use. OK.
Infiltration is prohibited in karst topography.	Not in karst. OK.
The bottom of the infiltration facility must be separated by at least two feet vertically from the seasonally high water table.	Elevation of seasonally high water table: 13' Elevation of BMP location: 20'. The difference is 7'. Thus, the trench can be up to 5' deep. OK.
Infiltration facilities must be located 100 feet horizontally from any water supply well.	No water supply wells nearby. OK.
Maximum contributing area generally less than 5 acres. (Optional)	3 acres. OK.
Setback 25 feet down-gradient from structures.	Fifty feet straight-line distance between the parking lot and the tree line. OK if the trench is 25' wide or narrower.

Step 4: Compute WQ_v peak discharge (Q_{wq})

- Compute Water Quality Volume:

WQ_v previously determined to be 8,102 cubic feet.

The peak rate of discharge for the water quality design storm is needed for the sizing of off-line diversion structures, such as sand filters and grass channels. Conventional SCS methods have been found to underestimate the volume and rate of runoff for rainfall events less than 2". This discrepancy in estimating runoff and discharge rates can lead to situations where a significant amount of runoff by-passes the filtering treatment practice due to an inadequately sized diversion structure or leads to the design of undersized grass channels.

The following procedure can be used to estimate peak discharges for small storm events. It relies on the volume of runoff computed using the Small Storm Hydrology Method (Pitt, 1994) and utilizes the NRCS, TR-55 Graphical Peak Discharge Method (USDA, 1986). A brief description of the calculation procedure is presented below.

$$CN = 1000/[10 + 5P + 10Q - 10(Q^2 + 1.25QP)^{1/2}]$$

where P = rainfall, in inches (use 1.5" for the Water Quality Storm)
and Q = runoff volume, in inches (equal to $WQ_v \div \text{area}$)

- Once a CN is computed, the time of concentration (t_c) is computed (based on the methods identified in TR-55, Chapter 3: "Time of concentration and travel time").
- Using the computed CN, t_c and drainage area (A), in acres; the peak discharge (Q_{wq}) for the Water Quality Storm is computed (based on the procedures identified in TR-55, Chapter 4: "Graphical Peak Discharge Method"). Use appropriate rainfall distribution type (typically Type II in the North Central Texas region).

Read initial abstraction (I_a), compute I_a/P

Read the unit peak discharge (q_u) for appropriate t_c

Using the water quality volume (WQ_v), compute the peak discharge (Q_{wq})

$$Q_{wq} = q_u * A * WQ_v$$

where

Q_{wq} = the peak discharge, in cfs
 q_u = the unit peak discharge, in cfs/mi²/inch
 A = drainage area, in square miles
 WQ_v = Water Quality Volume, in watershed inches

For this example, the steps are as follows:

Compute modified CN for 1.5" rainfall

$$P = 1.5''$$

$$Q = WQ_v \div \text{area} = (8,102 \text{ ft}^3 \div 3 \text{ ac} \div 43,560 \text{ ft}^2/\text{ac} \times 12 \text{ in/ft}) = 0.74''$$

$$\begin{aligned} CN &= 1000/[10 + 5P + 10Q - 10(Q^2 + 1.25*Q*P)^{1/2}] \\ &= 1000/[10 + 5*1.5 + 10*0.74 - 10(0.74^2 + 1.25*0.74*1.5)^{1/2}] \\ &= 91.1 \end{aligned}$$

Use CN = 91

For CN = 91 and the $T_c = 0.16$ hours, compute the Q_{wq} for a 1.5" storm. With the CN = 91, a 1.5" storm will produce 0.74" of runoff. $I_a = 0.198$, therefore $I_a/P = 0.198/1.5 = 0.132$. $q_u = 825$ csm/in, and therefore:

$$Q_{wq} = (825 \text{ csm/in}) (3.0 \text{ ac}/640\text{ac/sq mi.}) (0.74'') = \underline{2.86 \text{ cfs.}}$$

Step 5: Size the infiltration trench

The area of the trench can be determined by the following equation (Equation 20.1):

$$A = \frac{WQ_v}{(nd + kT / 12)}$$

Where:

- A = Surface Area
- n = porosity
- d = trench depth (feet)
- k = percolation (inches/hour)
- T = Fill Time (time for the practice to fill with water), in hours

Assume that:

- n = 0.32
- d = 5 feet (see above; feasibility criteria)
- k = 1 inch/hour (see above; site data)
- T = 2 hours

Therefore:

$$A = 8,102 \text{ ft}^3 / (0.32 \times 5 + 1 \times 2/12) \text{ ft}$$

$$A = 4,586 \text{ ft}^2$$

Since the width can be no greater than 25' (see above; feasibility), determine the length:

$$L = 4,586 \text{ ft}^2 / 25 \text{ ft}$$

$$L = 183 \text{ feet}$$

Assume that 1/3 of the runoff from the site drains to Point A and 2/3 drains to Point B. Use an L-shaped trench in the corner of the site (see Figure 29.4 for a site plan view). The surface area of the trench is proportional to the amount of runoff it drains (e.g., the portion draining from Point A is half as large as the portion draining Point B).

Step 6: Size the flow diversion structures

Since two entrances are used, two flow diversions are needed.

For the entire site:

$$Q_{100\text{-year}} = 29 \text{ cfs (See Figure 29.3)}$$

$$\text{Peak flow for } WQ_v = 2.86 \text{ cfs. (Step 3).}$$

For the first diversion (Point A)

Assume peak flow equals 1/3 of the value for the entire site.

Thus, $Q_{100\text{-year}} = 29/3 = 9.7 \text{ cfs}$

$$\text{Peak flow for } WQ_v = 2.86/3 = 0.95 \text{ cfs}$$

Size the low flow orifice to pass 0.95 cfs with 1.5' of head using the Orifice equation.

$$Q = CA(2gh)^{1/2}; 0.95 \text{ cfs} = 0.6A(2 \times 32.2 \text{ ft/s}^2 \times 1.5')^{1/2}$$

$$A = 0.16 \text{ sq. ft.} = \pi d^2/4; d = 0.45'; \text{ use 6" pipe with 6" gate valve}$$

Size the 100-year overflow weir crest at 22.5'. Use a concrete weir to pass the 100-year flow (9.7 – 0.95 = 8.75 cfs). Assume 1 foot of head to pass this event. Size using the weir equation.

$$Q = CLH^{1.5}; L = Q/(CH^{1.5})$$

$$L = 8.75 \text{ cfs} / (3.1)(1)^{1.5} = 2.8'; \text{ use 2.8' (see Figure 29.27)}$$

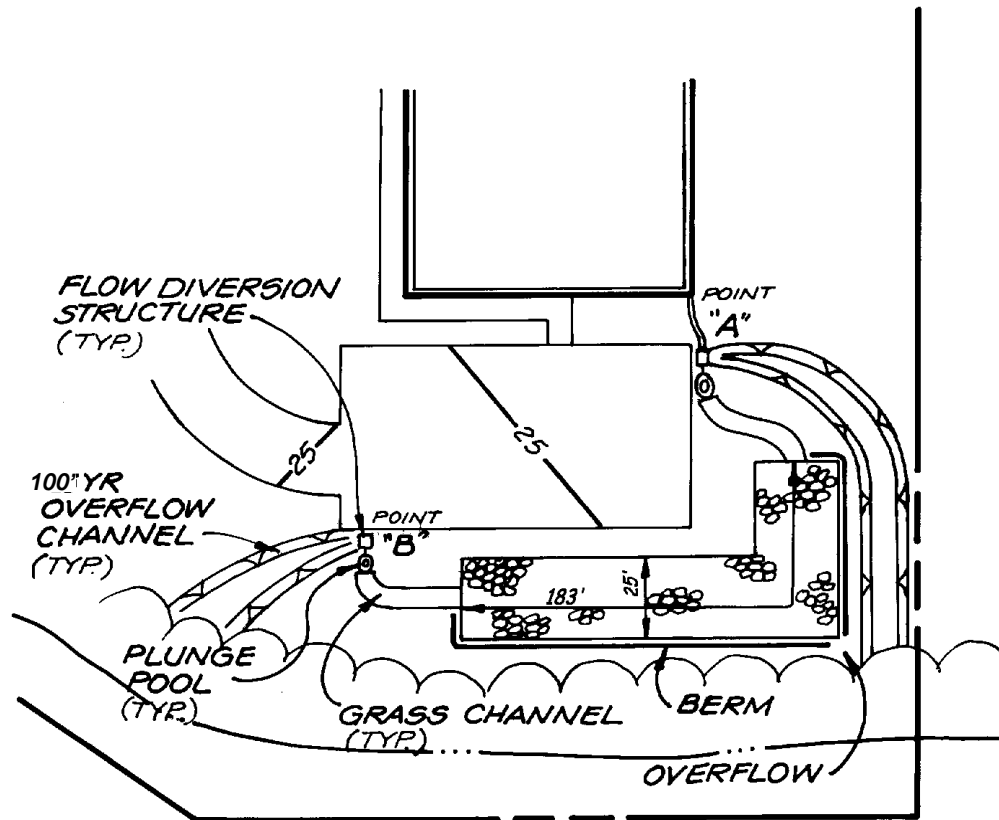

Figure 29.26 Infiltration Trench Site Plan

Size the second diversion (Point B) using the same techniques.

Peak flow equal 2/3 of the value for the entire site. Thus:

$$Q_{100\text{-year}} = 29 \times 0.67 = 19.3 \text{ cfs}$$

$$\text{Peak flow for } WQ_v = 2.86 \times 0.67 = 1.47 \text{ cfs}$$

Size the low flow orifice to pass 1.47 cfs with 1.5' of head using the Orifice equation.

$$Q = CA(2gh)^{1/2}; 1.91 \text{ cfs} = 0.6A(2 \times 32.2 \text{ ft/s}^2 \times 1.5')^{1/2}$$

$$A = 0.32 \text{ sq. ft.} = \pi d^2/4; d = 0.64'; \text{ use } 8" \text{ pipe with } 8" \text{ gate valve}$$

Size the 100-year overflow weir crest at 22.0'. Use a concrete weir to pass the 100-year flow (19.3 – 1.91 = 17.39 cfs). Assume 1 foot of head to pass this event. Size using the weir equation.

$$Q = CLH^{1.5}; L = Q/(CH^{1.5})$$

$$L = 17.39 \text{ cfs} / (3.1)(1)^{1.5} = 5.6; \text{ use } 5.6' \text{ (see Figure 29.27)}$$

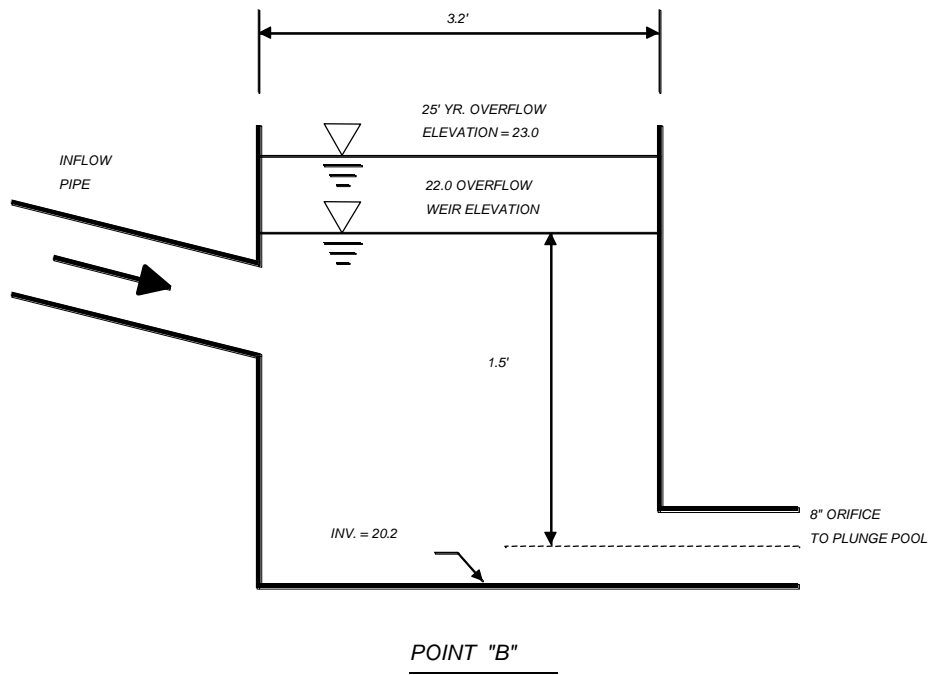
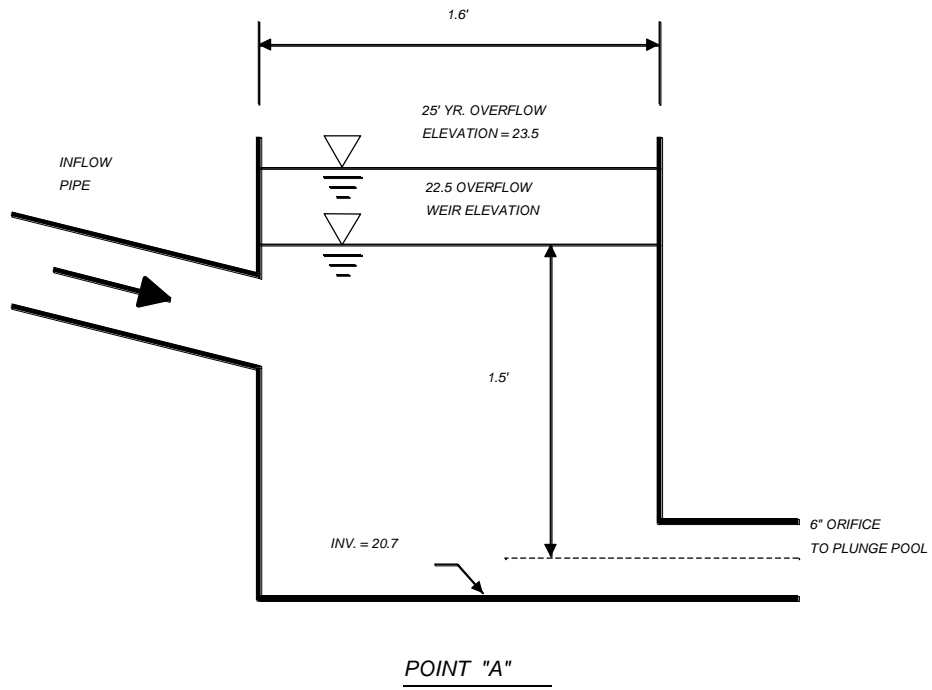

Figure 29.27 Flow Diversion Structures

Step 7: Size pretreatment volume and design pretreatment measures

As rule of thumb, size pretreatment to treat 25% of the WQ_v . Therefore, treat $8,102 \times 0.25 = 2,026 \text{ ft}^3$.

For pretreatment, use a pea gravel filter layer with filter fabric, a plunge pool, and a grass channel.

Pea Gravel Filter

The pea gravel filter layer covers the entire trench with 2" (see Figure 29.28). Assuming a porosity of 0.32, the water quality treatment in the pea gravel filter layer is:

$$WQ_{\text{filter}} = (0.32)(2")(1 \text{ ft}/12 \text{ inches})(4,586 \text{ ft}^2) = 245 \text{ ft}^3$$

Plunge Pools

Use a 5'X10' plunge pool at Point A and a 10'X10' plunge pool at Point B with average depths of 2'.

$$\text{Total } WQ_{\text{pool}} = (10 \text{ ft})(10+5 \text{ ft})(2 \text{ ft}) = 300 \text{ ft}^3$$

Grass Channel

Thus, the grass channel needs to treat at least $(2,026 - 245 - 300)\text{ft}^3 = 1,481 \text{ ft}^3$

Use a Manning's Equation nomograph or software to size the swale.

The channel at point A should treat one third of $1,481 \text{ ft}^3$ or 494 ft^3

- Assume a trapezoidal channel with 4' channel bottom, 3H:1V side slopes, and a Manning's n value of 0.15. Use a nomograph to size the swale; assume a 1% slope.
- Use a peak discharge of 0.95 cfs (Peak flow for one third of WQ_v , or $2,700 \text{ ft}^3$)
- Compute velocity: $V=0.47 \text{ ft/s}$
- To retain the $1/3$ of the WQ_v ($2,700 \text{ ft}^3$) for 10 minutes, the length would be 282 feet.
- Since the swale only needs to treat 25% of the water quality volume minus the treatment provided by the plunge pool and the gravel layer, or 494 ft^3 , the length should be pro-rated to reflect this reduction.

Therefore, adjust length:

$$L = (282 \text{ ft})(494 \text{ ft}^3/2,700 \text{ ft}^3) = 52 \text{ feet. Use 55 feet.}$$

The channel at point B should treat two thirds of $1,481 \text{ ft}^3$, or 988 ft^3

- Assume a trapezoidal channel with 5' channel bottom, 3H:1V side slopes, and a Manning's n value of 0.12. Use a nomograph to size the swale; assume a 0.5% slope.
- Use a peak discharge of 1.91 cfs (Peak flow for two thirds of WQ_v , or $5,401 \text{ ft}^3$)
- Compute velocity: $V=0.51 \text{ ft/s}$
- To retain the $2/3$ of the WQ_v ($5,401 \text{ ft}^3$) for 10 minutes, the length would be 306 feet.
- Since the swale only needs to treat 25% of the water quality volume minus the treatment provided by the plunge pool and the gravel layer, or 988 ft^3 , the length should be pro-rated to reflect this reduction.

Therefore, adjust length:

$$L = (306 \text{ ft})(988 \text{ ft}^3/5,401 \text{ ft}^3) = 55 \text{ feet. Use 55 feet.}$$

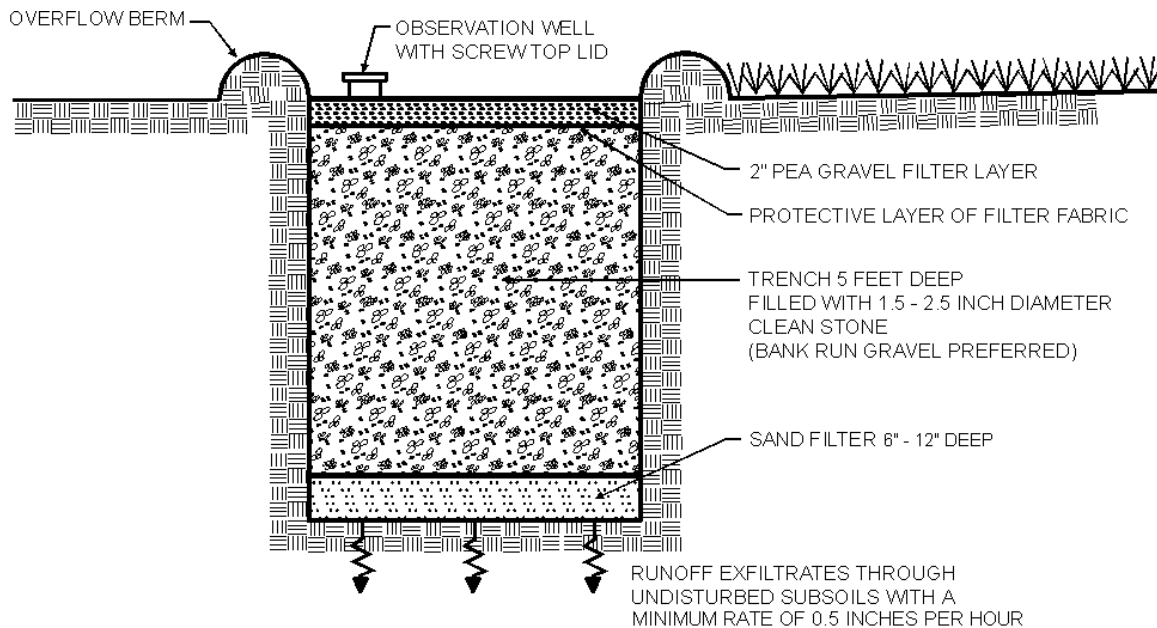

Figure 29.28 Infiltration Trench Cross Section

Step 8: Design Spillway(s)

Adequate stormwater outfalls should be provided for the overflow associated with the 100-year and larger design storm events, ensuring non-erosive velocities on the down slope.

29.6 Enhanced Swale Design Example

This example focuses on the design of a dry swale to meet the water quality treatment requirements of the site. The design options chosen for this example are Option 1 for Water Quality Protection (WQ_v), Option 4 for Streambank Protection (SP_v), and Option 4 for Flood Control (Q_{p100}). It is assumed that the criteria requires enhanced swales to adequately convey the 25-year peak flow. Streambank Protection and Flood Control are not addressed in this example other than quantification of preliminary storage volume and peak discharge requirements. It is assumed that the designer can refer to the previous pond example in order to extrapolate the necessary information to determine and design the required storage and outlet structures to meet these criteria. In general, the primary function of dry swales is to provide water quality treatment and groundwater recharge and not large storm attenuation. As such, flows in excess of the water quality volume are typically routed to bypass the facility. Where quantity control is required, the bypassed flows can be routed to conventional detention basins (or some other facility such as underground storage vaults). The layout of the Wellington Recreation Center is shown in Figure 29.29.

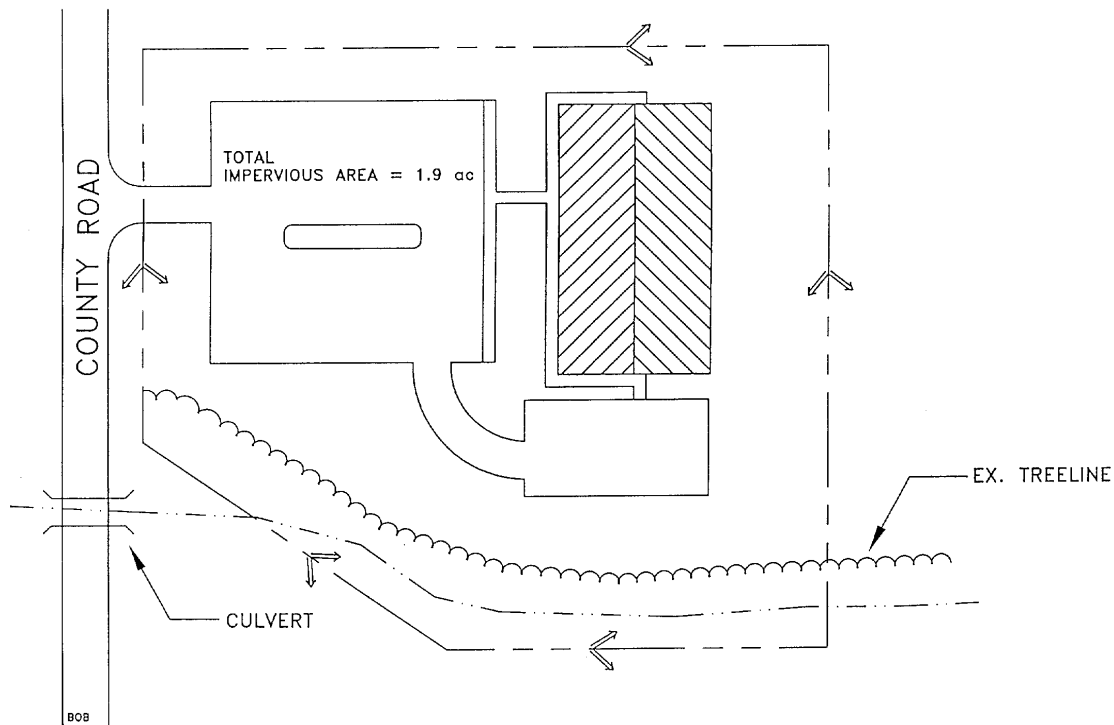

Figure 29.29 Wellington Recreation Center Site Plan

<u>Base Data</u>	<u>Hydrologic Data</u>	
Site Area = Total Drainage Area (A) = 3.0 ac	<u>Pre</u>	<u>Post</u>
Impervious Area = 1.9 ac; or I = 1.9/3.0 = 63.3%	CN	77
Soils Type 50% "C", 50% "D" Tarrant County	t_c	91
		.20

Computation of Preliminary Stormwater Storage Volumes and Peak Discharges

Two swales will be designed to carry flow to the existing stream, one around each side of the development.

Step 1: Compute runoff control volumes from the *integrated* Design Focus Areas

Compute Water Quality Volume (WQ_v):

- Compute Runoff Coefficient, R_v

$$R_v = 0.05 + (63.3)(0.009) = 0.62$$

- Compute WQ_v

$$\begin{aligned} WQ_v &= (1.5") (R_v) (A) / 12 \\ &= (1.5") (0.62) (3.0\text{ac}) (43,560\text{ft}^2/\text{ac}) (1\text{ft}/12\text{in}) \\ &= \underline{8,102 \text{ ft}^3} = 0.19 \text{ ac-ft} \end{aligned}$$

Compute Stream Streambank Protection Volume (SP_v):

For stream streambank protection, provide 24 hours of extended detention for the 1-year event.

In order to determine a preliminary estimate of storage volume for streambank protection and flood control, it will be necessary to perform hydrologic calculations using approved methodologies. This example uses the NRCS TR-55 methodology presented in [Section 1.1 of the Hydrology Technical Manual](#) to determine pre- and post-development peak discharges for the 1-yr, 25-yr, and 100-yr 24-hour return frequency storms.

- Per attached TR-55 calculations (Figures 29.30 and 29.31)

Condition	CN	Q _{1-year} <i>Inches</i>	Q _{1-year} <i>cfs</i>	Q _{100 year} <i>cfs</i>
Pre-developed	74	0.69	1.7	17.0
Post-Developed	90	1.66	6.5	33.0

- Utilize modified TR-55 approach to compute streambank protection storage volume

Initial abstraction (I_a) for CN of 90 is 0.222: [$I_a = (200/CN - 2)$]

$$I_a/P = (0.222)/ 2.64 \text{ inches} = 0.08$$

$$T_c = 0.21 \text{ hours}$$

$$q_u = 840 \text{ csm/in}$$

Knowing q_u and T (extended detention time), find q_o/q_i for a Type II rainfall distribution.

Peak outflow discharge/peak inflow discharge (q_o/q_i) = 0.022

For a Type II rainfall distribution,

$$V_s/V_r = 0.683 - 1.43(q_o/q_i) + 1.64(q_o/q_i)^2 - 0.804(q_o/q_i)^3$$

Where V_s equals streambank protection storage (SP_v) and V_r equals the volume of runoff in inches.

$$V_s/V_r = 0.65$$

$$\text{Therefore, } V_s = SP_v = 0.65(1.66''(1/12)(3 \text{ ac})) = 0.27 \text{ ac-ft} = 11,761 \text{ ft}^3$$

Analyze for Safe Passage of 100 Year Design Storm (Q_f):

At final design, prove that discharge conveyance channel is adequate to convey the 100-year event and discharge to receiving waters, or handle it with a peak flow control structure.

Symbol	Control Volume	Volume Required (cubic feet)	Notes
WQ _v	Water Quality	8,102	
SP _v	Streambank Protection	11,761	
Q _f	Flood Protection	NA	Provide safe passage for the 100-year event in final design

PEAK DISCHARGE SUMMARY				
JOB:	Wellington of Recreation Center			EWB
DRAINAGE AREA NAME:	Pre-Developed Conditions			
COVER DESCRIPTION	SOIL GROUP A, B, C, D?	C from TABLE 1.6 Hydrology Section	CN from TABLE 1.9 Hydrology Section	AREA (in acres)
woods (good cond.)	C		70	1.5
woods (good cond.)	D		78	1.5
AREA SUBTOTALS:				3.00
Time of Concentration	Surface Cover	Manning 'n'	Flow Length	Slope
2-Yr 24 Hr Rainfall = 3.36"	Cross Section	Wetted Per	Avg Velocity	Tt (hrs)
Sheet Flow	dense grass	'n'= 0.24	150 ft	1.50%
				0.36 hrs
Shallow Flow	unpaved		500 ft	2.00%
			2.28 fps	0.06 hrs
Channel Flow				
Total Area in Acres =	3.00	Total Sheet	Total Shallow	Total Channel
Weighted CN =	74	Flow =	Flow =	Flow =
Time of Concentration =	0.42 hrs	0.36 hrs.	0.06 hrs.	0.00 hrs.
Pond Factor =	1	RAINFALL TYPE II		
STORM	Precipitation (P) inches	Runoff (Q)	Qp, PEAK DISCHARGE (cfs)	
1 Year	2.64	0.69	1.7	
2 Year	3.36	1.14	3.0	
5 Year	4.56	2.02	5.4	
10 Year	5.52	2.79	7.6	
25 Year	6.72	3.80	11.0	
50 Year	7.92	4.85	14.0	
100 Year	9.12	5.94	17.0	

Figure 29.30 Wellington Recreation Center Pre-Developed Conditions

PEAK DISCHARGE SUMMARY				
JOB:	Wellington on Recreation Center			EWB
DRAINAGE AREA NAME:	Post-Developed Conditions			3-Jan-00
COVER DESCRIPTION	SOIL GROUP A, B, C, D?	C from TABLE 1.6 Hydrology Section	CN from TABLE 1.9 Hydrology Section	AREA (in acres)
open space (good cond.)	C		74	0.25
woods (good cond.)	C		70	0.30
impervious	C		98	1.90
open space (good cond.)	D		80	0.25
woods (good cond.)	D		77	0.30
AREA SUBTOTALS:				3.00
Time of Concentration	Surface Cover	Manning 'n'	Flow Length	Slope
2-Yr 24 Hr Rainfall = 3.36"	Cross Section	Wetted Per	Avg Velocity	Tt (hrs)
Sheet Flow	dense grass	'n'= 0.24	50 ft	1.50%
				0.15 hrs
Shallow Flow	paved		600 ft	2.00%
			2.87 fps	0.06 hrs
Channel Flow		'n'= 0.024	50 ft	2.00%
Hydraulic Radius= 0.75	X-S estimated	WP estimated	7.25 fps	0.00hrs
Total Area in Acres =	3.00	Total Sheet	Total Shallow	Total Channel
Weighted CN =	90	Flow =	Flow =	Flow =
Time of Concentration =	0.21 hrs	0.15 hrs.	0.06 hrs.	0.00 hrs.
Pond Factor =	1	RAINFALL TYPE II		
STORM	Precipitation (P) inches	Runoff (Q)	Qp, PEAK DISCHARGE (cfs)	
1 Year	2.64	1.66	6.5	
2 Year	3.36	2.32	9.3	
5 Year	4.56	3.45	14.0	
10 Year	5.52	4.38	18.0	
25 Year	6.72	5.55	23.0	
50 Year	7.92	6.73	28.0	
100 Year	9.12	7.91	33.0	

Figure 29.31 Wellington Recreation Center Post-Developed Conditions

Step 2: Determine if the development site and conditions are appropriate for the use of an enhanced dry swale system

Existing ground elevation at the facility location is 922.0 feet, mean sea level. Soil boring observations reveal that the seasonally high water table is at 913.0 feet and underlying soils are predominately clay. Adjacent creek invert is at 912.0 feet.

Step 3: Confirm local design criteria and applicability

There is a local requirement that the 25-year storm is contained within the top of banks of all channels, including these enhanced swale controls.

No additional criteria are applicable.

Step 4: Determine pretreatment volume

Size two shallow forebays at the head of the swales equal to 0.05" per impervious acre of drainage (each) (Note, total recommended pretreatment requirement is 0.1"/imp acre). (1.9 ac) (0.05") (1ft/12") (43,560 sq ft/ac) = 344.9 ft^3

Use a 2' deep pea gravel drain at the head of the swale to provide erosion protection and to assist in the distribution of the inflow. There will be no side inflow nor need for pea gravel diaphragm along the sides.

Step 5: Determine swale dimensions

Required: bottom width, depth, length, and slope necessary to store WQ_v with less than 18" of ponding (see Figure 29.32 for representative site plan).

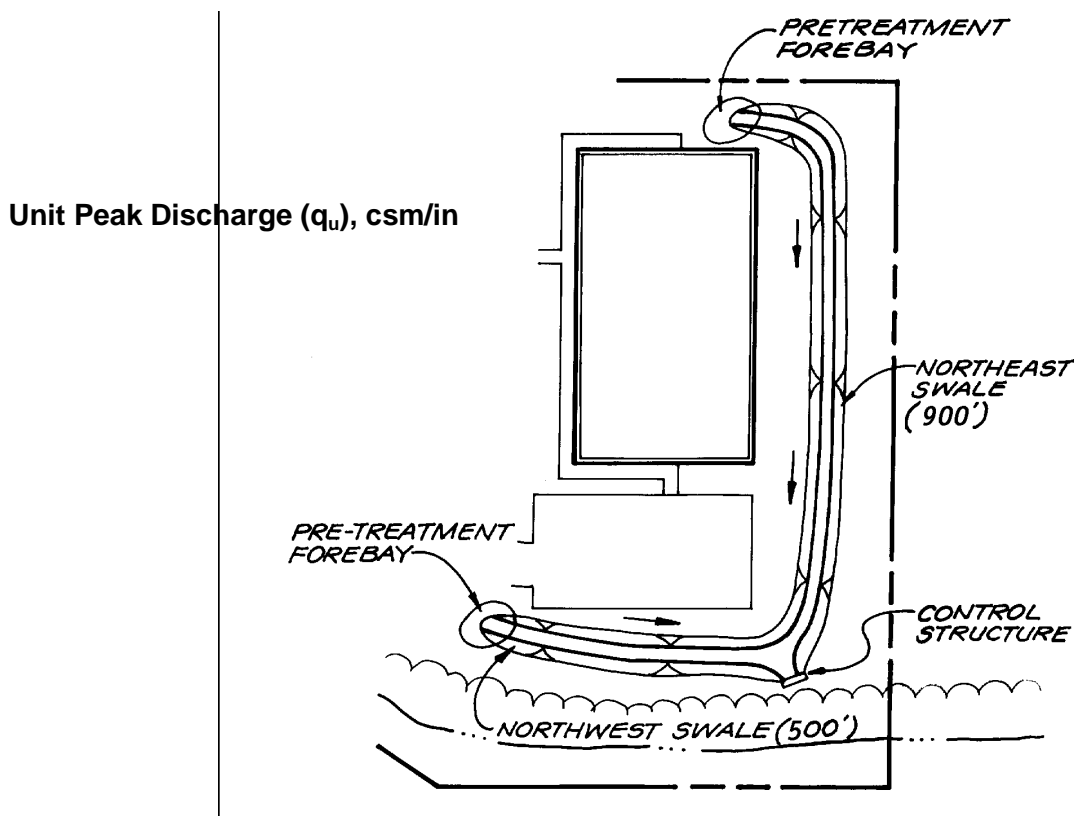

Figure 29.32 Enhanced Dry Swale Site Plan

Assume a trapezoidal channel with a maximum WQ_v depth of 18". Control for this swale will be a shallow concrete wall with a low flow orifice, trash rack located per Figures 29.5 and 29.6. Per the site plan, we have about 1,400' of swale available, if the swale is put in with two tails. The outlet control will be set at the existing invert minus three feet ($922.0 - 3.0 = 919.0$). The existing uphill invert for the northwest fork is 924.0 (length of 500'), the invert for the northeast fork is 928.0 (at a length of 900').

Slope of northwest fork is $(924 - 919)/500' = 0.01$ or 1.0%

Slope of northeast fork is $(928 - 919)/900' = 0.01$ or 1.0%

Minimum slope is 1.0 % [okay]

For a trapezoidal section with a bottom width of 6', a WQ_v average depth of 9", 3:1 side slopes, compute a cross sectional area of $(6') (0.75') + (0.75') (2.25') = 6.2 \text{ ft}^2$ (see Figure 29.34).

$(6.2 \text{ sq ft}) (1,400 \text{ ft}) = 8,680 \text{ cubic feet } [> WQ_v \text{ of } 8,102 \text{ ft}^3; \text{OK}]$

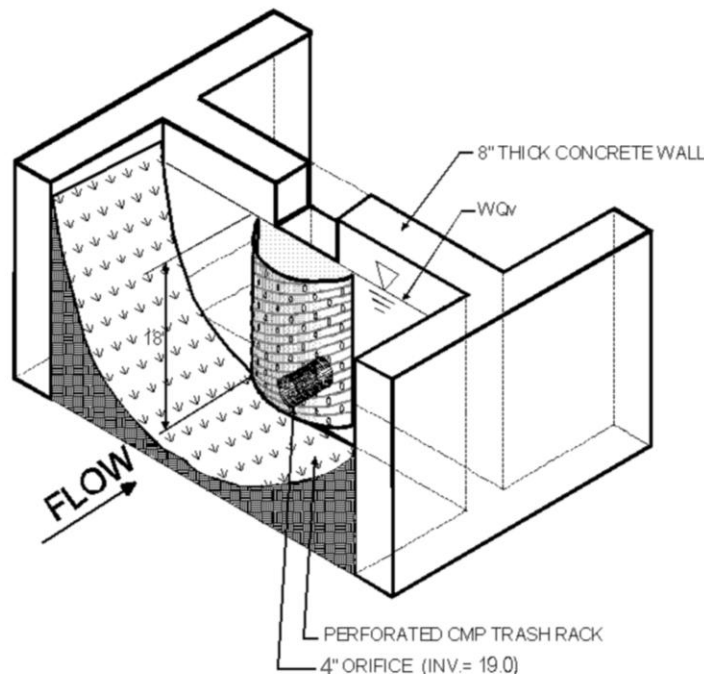

Figure 29.33 Control Structure at End of Swale

Step 6: Compute number of check dams (or similar structure) required to detain WQ_v (see Figure 29.7)

For the northwest fork, 500 ft @ 1.0% slope, and maximum depth at 18", place checkdams at:

$$1.5'/0.01 = 150' \quad \text{place at 150', 4 required}$$

For the northeast fork, 900 ft @ 1.0% slope, and maximum 18" depth, place checkdams at:

$$1.5'/0.01 = 150' \quad \text{place at 150', 6 required}$$

Step 7: Calculate draw-down time

In order to ensure that the swale will draw down within 24 hours, the planting soil will need to pass a maximum rate of 1.5' in 24 hours ($k = 1.5'$ per day). Provide 6" perforated underdrain pipe and gravel system below soil bed (see Figure 29.34).

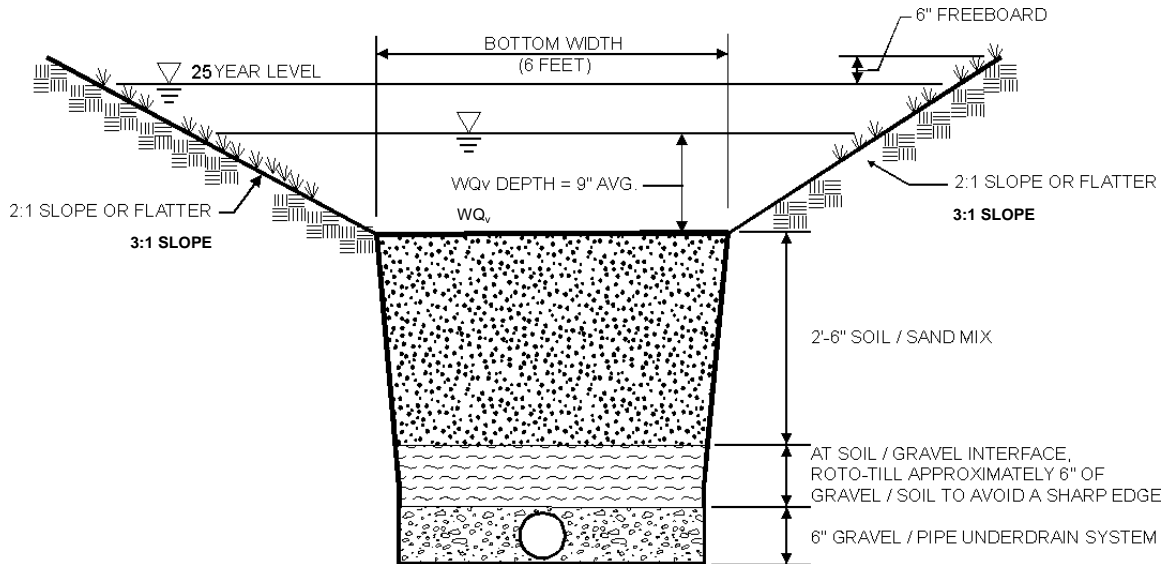

Figure 29.34 Trapezoidal Dry Swale Section

Step 8: Check 25-year flows for velocity erosion potential and freeboard

Given the local requirements to contain the 25-year flow within banks with freeboard. In this example only the 25-year flow will be checked assuming that lower flows will be handled. The 25-year flow is 23.0 cfs, assume that 30% goes through northwestern swale (6.9 cfs) and 70% goes through the northeastern swale (9.3 cfs). Design for the larger amount (13.3 cfs). From separate computer analysis, with a slope of 1.0%, the 25-year velocity will be 2.7 feet-per-second at a depth of .63 feet, provide an additional .5' of freeboard above top of checkdams or about 1.2' (total channel depth = 2.7').

Find 25-year overflow weir length required: (weir eq. $Q = CLH^{3/2}$), where $C = 3.1$, $Q_{25} = 23$ cfs, $H = 1.2$; Rearranging the equation yields:

$$L = 23 \text{ cfs} / (3.1 * 1.2^{1.5}) = 5.6' \quad \text{Use 5 ft}$$

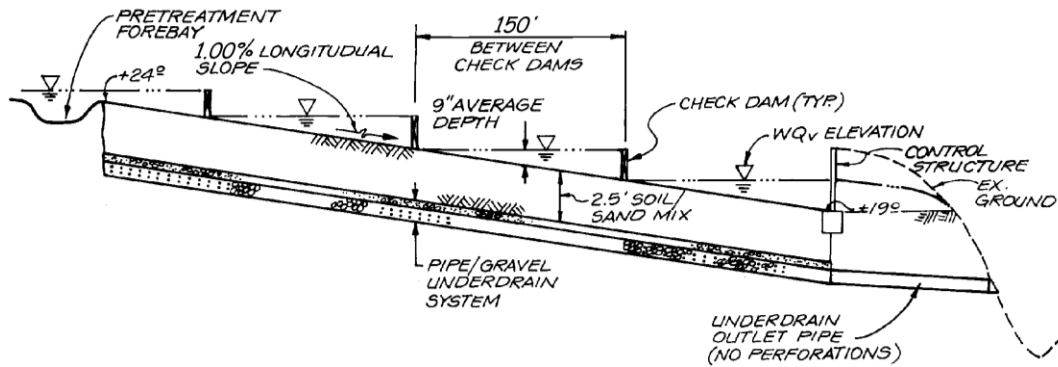

Figure 29.35 Profile of Northwest Fork Dry Swale

Step 9: Design low flow orifice at downstream headwall and checkdams (See Figure 29.33)

Design orifice to pass 8,102 cubic feet in 6 hours.

$$8,102 \text{ cubic feet} / [(6 \text{ hours}) (3600 \text{ sec/hour})] = 0.4 \text{ cfs}$$

Use Orifice equation: $Q = CA(2gh)^{1/2}$

Assume $h = 1.5'$

$$A = (0.4 \text{ cfs}) / [(0.6) ((2) (32.2 \text{ ft/s}^2) (1.5'))^{1/2}]$$

$$A = 0.068 \text{ sq ft, dia} = 0.29 \text{ feet or } 3.6'' \text{ Use } 4'' \text{ orifice.}$$

Provide 3" v-notch slot in each check dam.

Step 10: Design inlets, sediment forebay(s), and underdrain system

See Figure 29.35

Step 11: Prepare Vegetation and Landscaping Plan

30.0 References

California Storm Water Quality Task Force, 1993. California Storm Water Best Management Practice Handbooks.

Center for Watershed Protection (CWP), 1996. Design of Stormwater Filtering Systems. Prepared for Chesapeake Research Consortium.

City of Austin, TX, 1988. Water Quality Management. Environmental Criteria Manual. Environmental and Conservation Services.

City of Sacramento, CA, 2000. Guidance Manual for On-Site Stormwater Quality Control Measures. Department of Utilities.

Debo, Thomas N., and Reese, Andrew J., 2003. Municipal Stormwater Management, 2nd Ed. Lewis Publishers, Boca Raton, FL. (See Chapter 13.)

Denver Urban Drainage and Flood Control District (UDFCD), 1999. Urban Storm Drainage Criteria Manual.

Denver Urban Drainage and Flood Control District (UDFCD), 1999. Urban Storm Drainage Manual. Volume 3.

Galli, J., 1990. Peat-Sand Filters: A Proposed Stormwater Management Practice for Urbanized Areas. Metropolitan Washington Council of Governments.

Galli, J., 1992. Analysis of Urban BMP Performance and Longevity in Prince George's County, Maryland. Metropolitan Washington Council of Governments.

Harper, H., and J. Herr. Alum Treatment of Stormwater Runoff: The First Ten Years. Environmental Research & Design, Inc.

Harper, H., J. Herr, and E. Livingston. Alum Treatment of Stormwater Runoff – An Innovative BMP for Urban Runoff Problems. Environmental Research & Design, Inc. Orlando, FL. With Florida Department of Environmental Protection.

LACDPW, 2000 - Los Angeles County Department of Public Works.

Lager, J., W. Smith, R. Finn, and E. Finnemore, 1997. Urban Stormwater Management and Technology: Update and Users Guide. US EPA. EPA-600/8-77-014.

Maryland, 1984. State of Maryland BMP Design Manual, 1984.

Maryland Department of the Environment, 2000. Maryland Stormwater Design Manual, Volumes I and II. Prepared by Center for Watershed Protection (CWP).

Massachusetts Department of Environmental Protection / Massachusetts Office of Coastal Zone Management, 1997. Stormwater Management – Volume One: Stormwater Policy Handbook, and Volume Two: Stormwater Technical Handbook.

National Pollutant Removal Performance Database, 2nd Ed. www.cwp.org

National Storm Water Best Management Practices (BMP) Database. www.bmpdatabase.org

Northern Virginia Regional Commission (NVRC), 1992. The Northern Virginia BMP Handbook. Annandale, VA.

Northern Virginia Regional Commission (NVRC), 1992. Underground Detention Tanks as a Best Management Practice.

Pain, Jack, 1992. Portland Cement Pervious Pavement Construction: Vol. 37 No. 9, 4pp.

Pitt, R., M. Lilburn, S. Nix, S. Durrans, and S. Burian, 1997. Guidance Manual for Integrated Wet Weather Flow Collection and Treatment Systems for Newly Urbanized Areas. US EPA. Office of Research and Development.

Rouge River National Wet Weather Demonstration Project (Rouge Project), 1992. www.wcdoe.org/rougeriver/

Schueler, T., 1987. Controlling Urban Runoff: A Practical Manual for Planning and Designing Urban BMPs. Metropolitan Washington Council of Governments.

Soil Conservation Service (SCS), 1986. Urban Hydrology for Small Watersheds. United States Department of Agriculture. Engineering Division. Technical Release 55.

Texas Commission of Environmental Quality. Texas Administrative Code, 30 TAC Part 1, Chapter 299, Dams and Reservoirs. www.tnrcc.state.tx.us/enforcement/dam_safety/intro2.html

Texas Natural Resource Conservation Commission, 2000. Texas Nonpoint Source Book. www.txnpsbook.org

US EPA, 1999. Storm Water Technology Fact Sheet: Vegetated Swales. EPA 832-F-99-006. Office of Water

US EPA, 1999. Storm Water Technology Fact Sheet: Sand Filters. EPA 832-F-99-007. Office of Water.

US EPA, 1999. Storm Water Technology Fact Sheet: Bioretention. EPA 832-F-99-012. Office of Water

US EPA, 1999. Storm Water Technology Fact Sheet: Infiltration Trench. EPA 832-F-99-019. Office of Water.

US EPA, 1999. Storm Water Technology Fact Sheet: Porous Pavement. EPA 832-F-99-023. Office of Water.

US EPA, 1999. Storm Water Technology Fact Sheet: Storm Water Wetlands. EPA 832-F-99-025. Office of Water.

US EPA, 1999. Storm Water Technology Fact Sheet: Modular Treatment Systems. EPA 832-F-99-044. Office of Water.

Virginia Department of Conservation and Recreation, 1999. Virginia Stormwater Management Handbook, Volumes I and II.

Washington State Department of Ecology, 2000. Stormwater Management Manual for Western Washington.

Watershed Management Institute (WMI), 1997. Operation, Maintenance, and Management of Stormwater Management Systems. Prepared for US EPA, Office of Water.

Wisconsin Department of Natural Resources / University of Wisconsin Extension, 2000. The Wisconsin Stormwater Manual.

Winer, R., 2000. National Pollutant Removal Performance Database for Stormwater BMPs. Center for Watershed Protection. US EPA, Office of Science and Technology.